

# IK1550 Internetworking/Internetteknik

## Spring 2010, Period 4

Lecture notes of G. Q. Maguire Jr.

For use in conjunction with James F. Kurose and Keith W. Ross, *Computer Networking: A Top-Down Approach*, Fifth Edition, Pearson, 2010.



KTH Information and  
Communication Technology

© 2010 G.Q.Maguire Jr. .

All rights reserved. No part of this course may be reproduced, stored in a retrieval system, or transmitted, in any form or by any means, electronic, mechanical, photocopying, recording, or otherwise, without written permission of the author.

Last modified: 2010.03.21:17:38

|   |    |
|---|----|
| Module 1: Introduction .....                                | 1  |
| Welcome to the Internetworking course!.....                 | 2  |
| Staff Associated with the Course .....                      | 3  |
| Instructor (Kursansvarig) - - - - -                         | 3  |
| Goals, Scope and Method .....                               | 4  |
| Goals of the Course - - - - -                               | 4  |
| Scope and Method - - - - -                                  | 4  |
| Aim .....   | 5  |
| Learning Outcomes .....                                     | 6  |
| Prerequisites .....   | 8  |
| Contents .....  | 9  |
| Topics.....   | 10 |
| Examination requirements .....                              | 11 |
| Grades: A..F (ECTS grades) .....                            | 12 |
| Ethics, Rights, and Responsibilities.....                   | 13 |
| Written Assignment .....                                    | 14 |
| Assignment Registration and Report .....                    | 15 |
| Literature.....   | 16 |
| Lecture Plan .....  | 18 |
| Context of the course .....                                 | 19 |
| Context of the module.....                                  | 20 |
| From PANs to RANs and beyond.....                           | 21 |
| How can we deal with all of these different networks? ..... | 22 |

|  |           |
|--|-----------|
| Internetworking .....  | 23        |
| Basic concepts.....  | 24        |
| How does this avoid the “B-ISDN debacle”? .....                                  | 25        |
| Internetworked Architecture .....  | 26        |
| Internet Trends .....  | 27        |
| Trends: Shifting from traditional telecommunications to data communications..... | 28        |
| Power of the Internet (chaos).....   | 29        |
| IP traffic growing exponentially!.....   | 30        |
| Traffic increasing (but <b>not</b> due to voice)- - - - -                        | 30        |
| Fixed Links - arbitrarily fast: - - - - -  | 30        |
| Points of Presence (PoPs) + FIX/CIX/GIX/MAE P <b>GigaPoPs</b> - - - - -          | <b>30</b> |
| Speed.....   | 31        |
| Growth rates.....  | 32        |
| ¿Question?.....  | 33        |
| Increasing Data Rates .....  | 34        |
| “Ethernet” - - - - -   | 34        |
| Optical - - - - -  | 34        |
| Wireless - - - - -   | 34        |
| Internetworking .....  | 35        |
| The Internet Today.....  | 36        |
| Clean slate re-design of the Internet .....                                      | 37        |
| Implicit vs. Explicit Information.....   | 38        |
| Review of Layering.....  | 39        |
| Encapsulation .....  | 40        |
| Demultiplexing .....   | 41        |

|  |    |
|--|----|
| Addresses in TCP/IP .....  | 42 |
| Internet Protocol version 4 (IPv4) (RFC 791) .....               | 43 |
| IP “Protocol” field (RFC 1700) .....                             | 44 |
| Basic communication mechanism: datagram.....                     | 52 |
| Basic Ethernet + IP Software Architecture.....                   | 53 |
| Common Used Simple Services.....                                 | 54 |
| Link Layer.....  | 55 |
| Simple Campus Network .....                                      | 56 |
| Connecting Devices .....   | 57 |
| How important are switches vs. routers?.....                     | 58 |
| LAN Protocols .....  | 59 |
| Ethernet Encapsulation (RFC 894) .....                           | 60 |
| IEEE 802.2/802.3 Encapsulation (RFC 1042).....                   | 61 |
| IEEE 802 Numbers of Interest.....                                | 62 |
| SLIP (RFC 1055) .....  | 63 |
| SLIP Problems $\Rightarrow$ CSLIP $\equiv$ Compressed SLIP ..... | 64 |
| Robust Header Compression (rohc).....                            | 65 |
| PPP: Point to Point Protocol .....                               | 66 |
| PPP frames .....   | 67 |
| PPP summary .....  | 68 |
| Loopback interface.....  | 69 |
| Loopback interface summary.....                                  | 70 |

|  |     |
|--|-----|
| Virtual Interface (VIF).....                           | 71  |
| Using VIF for tunneling.....                           | 72  |
| Wireshark, tcpdump, etc. ....                          | 73  |
| Exporting data to other tools.....                     | 77  |
| Comma Separated Values .....                           | 79  |
| Importing in to a Microsoft Excel spreadsheet.....     | 80  |
| Example of what can be done .....                      | 83  |
| Using a Perl script.....                               | 84  |
| Choosing which columns to display .....                | 86  |
| IP addresses.....                                      | 89  |
| Classful addressing .....                              | 90  |
| Classless addressing:                                  |     |
| Subnetting IP networks .....                           | 91  |
| Special Case IP Addresses .....                        | 92  |
| Subnet mask.....                                       | 93  |
| Classless Inter-Domain Routing (CIDR).....             | 94  |
| IP address assignments .....                           | 96  |
| Private addresses.....                                 | 97  |
| Problems with the dual functions of IP addresses ..... | 98  |
| ifconfig, route, and netstat Commands .....            | 99  |
| Standardization Organizations.....                     | 100 |
| Summary .....  | 101 |

|                         |     |
|-------------------------|-----|
| W. Richard Stevens..... | 102 |
| References.....         | 103 |

|  |    |
|--|----|
| Module 2: IP Basics: Routing, ARP, and RARP.....       | 1  |
| IP Basics Outline.....                                 | 2  |
| Connection-oriented vs Connectionless.....             | 3  |
| Routing.....   | 4  |
| Direct vs. indirect Delivery.....                      | 5  |
| Forwarding.....  | 6  |
| Processing.....  | 7  |
| Forwarding module.....                                 | 8  |
| Routing Table Search - Classless.....                  | 9  |
| Fast forwarding.....                                   | 10 |
| Routing Tables.....                                    | 11 |
| Routing table.....                                     | 12 |
| Host vs. router - two behaviors.....                   | 13 |
| Host routing.....                                      | 14 |
| Routing.....   | 15 |
| Combining layers.....                                  | 16 |
| ARP and RARP.....                                      | 17 |
| What to do with a new computer?.....                   | 18 |
| Address Resolution: ARP, RARP.....                     | 19 |
| ARP $\equiv$ Address Resolution Protocol (RFC826)..... | 20 |
| ARP example 1.....                                     | 21 |
| Address Resolution Cache.....                          | 22 |

|  |    |
|--|----|
| ARP Refinements. . . . .                                 | 22 |
| ARP Timeouts.....  | 23 |
| ARP example 2 .....                                      | 24 |
| Proxy ARP (RFC 826).....                                 | 25 |
| Gratuitous ARP .....                                     | 26 |
| Additional ARP commands .....                            | 27 |
| ARP - as seen with ethereal .....                        | 28 |
| non ARP example 1 .....                                  | 29 |
| RARP: Reverse Address Resolution Protocol (RFC 903)..... | 30 |
| RARP - as seen with ethereal.....                        | 31 |
| RARP server .....  | 32 |
| Alternatives to RARP .....                               | 33 |
| Novel IPX/SPX Addresses .....                            | 34 |
| Useful tools .....                                       | 35 |
| tcpdump.....   | 36 |
| tcpdump - Linux.....                                     | 37 |
| Tools Used: tcpdump Program .....                        | 38 |
| Wireshark (formerly Ethereal).....                       | 39 |
| Linux Socket filter .....                                | 41 |
| Tools Used: sock Program.....                            | 42 |
| Tools Used: sock + tcpdump .....                         | 43 |
| Generating packets.....                                  | 44 |



|   |    |
|---|----|
| Wireshark's IO Graph functionality .....  | 46 |
| Some statistics on this packet trace..... | 47 |
| Interarrival delay and variance.....      | 48 |
| Traffic generators.....                   | 49 |
| Summary .....                             | 50 |
| References.....                           | 51 |

|  |    |
|--|----|
| Module 3: IP, ICMP, and Tools .....                  | 1  |
| IP, ICMP, and Tools Outline .....                    | 2  |
| Internet Protocol version 4 (IPv4) (RFC 791) .....   | 3  |
| Length Fields .....                                  | 5  |
| MTU <sup>1/2</sup> ≡Maximum Transmission Unit .....  | 6  |
| Fragmentation .....                                  | 7  |
| Fields relevant to Fragmentation .....               | 8  |
| Path MTU.....  | 9  |
| Serial line throughput.....                          | 10 |
| Differentiated Services (DS) & Type of Service ..... | 11 |
| Recommended Value for TOS Field.....                 | 13 |
| Precedence .....                                     | 14 |
| Problems with precedence .....                       | 15 |
| Precedence and telephony systems .....               | 16 |
| Differentiated services .....                        | 17 |
| TTL field.....                                       | 18 |
| Header Checksum .....                                | 19 |
| IPv4 Options .....                                   | 20 |
| IP Options Encoding .....                            | 21 |
| Categories of IP Options.....                        | 22 |
| Internet Control Message Protocol (ICMP).....        | 23 |
| ICMP Port Unreachable Error .....                    | 24 |

|   |           |
|---|-----------|
| ICMP Redirect .....                                     | 25        |
| PING: Packet InterNet Groper or <b>sonar echo</b> ..... | <b>26</b> |
| PING examples .....                                     | 27        |
| On a HP-UX 11.0 machine: . . . . .                      | 28        |
| Ping with record route option .....                     | 29        |
| Useful Tool: Traceroute Programs.....                   | 30        |
| ICMP Summary .....                                      | 31        |
| Summary .....   | 32        |
| References .....  | 33        |

|   |    |
|---|----|
| Module 4: UDP and friends .....               | 1  |
| Outline.....                                  | 2  |
| Transport layer protocols .....               | 3  |
| Main Transport layer protocols.....           | 4  |
| User Datagram Protocol (UDP) .....            | 5  |
| UDP Header .....                              | 6  |
| UDP Checksum and Pseudo-Header .....          | 7  |
| Reserved and Available UDP Port Numbers ..... | 8  |
| Port numbers in three groups .....            | 9  |
| MTU and Datagram Fragmentation.....           | 10 |
| Fragmentation Required.....                   | 11 |
| Interaction between UDP and ARP .....         | 12 |
| Still a problem? .....                        | 14 |
| With an even larger UDP packet .....          | 15 |
| Maximum UDP Datagram size .....               | 16 |
| Datagram truncation.....                      | 17 |
| Socket API .....                              | 18 |
| Learning about Socket programming.....        | 19 |
| Simple UDP client .....                       | 20 |
| UDP server design . . . . .                   | 21 |
| UDP listener example . . . . .                | 22 |
| Changed the client . . . . .                  | 23 |

|   |    |
|---|----|
| Building a UDP packet from scratch .....                    | 24 |
| ICMP Source Quench Error. . . . .                           | 27 |
| No error control.....                                       | 29 |
| BOOTP: Bootstrap Protocol (RFC 951).....                    | 30 |
| BOOTP continued.....  | 31 |
| Vendor specific information<br>(RFC 1497 and RFC1533) ..... | 32 |
| DHCP: Dynamic Host Configuration Protocol (RFC 1531) .....  | 33 |
| DHCP's importance .....                                     | 37 |
| How big a problem is manual configuration? - - - - -        | 37 |
| DHCP performance problems.....                              | 38 |
| Example of dhcpd.conf .....                                 | 39 |
| DHCP and DNS .....  | 40 |
| Trivial File Transfer Protocol (TFTP) .....                 | 41 |
| Mapping names to IP addresses .....                         | 43 |
| DNS: Domain Name Service<br>(RFC 1034, RFC 1035).....       | 44 |
| Zones.....  | 45 |
| DNS Message format .....                                    | 46 |
| Internet's top level domains.....                           | 47 |
| New top level domains.....                                  | 48 |
| Domain registrars.....                                      | 49 |
| Country Code Top-Level Domains (CCTLDs) .....               | 50 |

|   |    |
|---|----|
| Resource Records (RR).....                  | 51 |
| Network names .....                         | 53 |
| Example: .....                              | 55 |
| MX information .....                        | 56 |
| Host names and info.....                    | 57 |
| Storing other attributes - TXT records..... | 58 |
| Configuring DNS .....                       | 59 |
| Root servers .....                          | 60 |
| Load leveling [1].....                      | 61 |
| F root nameserver nodes .....               | 62 |
| Where is f.root-servers.net ? .....         | 63 |
| Where is i.root-servers.net ? .....         | 64 |
| Dynamic Domain Name System (DDNS) .....     | 65 |
| DDNS.....                                   | 66 |
| Attacks upon DNS .....                      | 67 |
| DNS performance .....                       | 68 |
| DNS performance - top 100.....              | 69 |
| Web performance.....                        | 70 |
| Web performance - continued.....            | 71 |
| Public/Commercial DNS services.....         | 72 |
| Summary .....                               | 73 |
| References .....                            | 74 |

|   |    |
|---|----|
| Module 5: TCP, HTTP, RPC, NFS, X.....     | 1  |
| Lecture 4: Outline .....                  | 2  |
| Transport layer protocols .....           | 3  |
| Transmission Control Protocol (TCP) ..... | 4  |
| Applications which use TCP .....          | 5  |
| TCP Header.....                           | 6  |
| TCP header continued.....                 | 7  |
| Connection establishment .....            | 9  |
| SYN Flooding Attack .....                 | 10 |
| Connection teardown .....                 | 11 |
| TCP options .....                         | 12 |
| Maximum Segment Size .....                | 13 |
| Sliding window Flow control. ....         | 14 |
| Window size. ....                         | 15 |
| Flow for an rlogin session .....          | 16 |
| Silly Window Syndrome .....               | 17 |
| Nagle Algorithm .....                     | 18 |
| Disabling the Nagle Algorithm .....       | 19 |
| Delayed acknowledgements. ....            | 20 |
| Resulting bulk data flow .....            | 21 |
| Bandwidth-Delay Product .....             | 22 |
| Congestion Avoidance .....                | 23 |

|  |    |
|--|----|
| Congestion Control . . . . .   | 24 |
| Slow start . . . . .   | 25 |
| Round-Trip Time Measurement . . . . .                                | 27 |
| Karn's algorithm . . . . .   | 28 |
| Congestion Avoidance Algorithm . . . . .                             | 29 |
| Van Jacobson's Fast retransmit and Fast Recovery Algorithm . . . . . | 30 |
| Per-Route Metrics . . . . .  | 31 |
| TCP Persist Timer . . . . .  | 32 |
| TCP Keepalive Timer . . . . .  | 33 |
| TCP Performance. . . . .   | 34 |
| Long Fat Pipes . . . . .   | 35 |
| Measuring TCP Performance. . . . .                                   | 36 |
| Example of TCP behavior . . . . .                                    | 37 |
| TCP servers.....   | 38 |
| Hypertext Transfer Protocol (HTTP).....                              | 39 |
| HTTP Prococol . . . . .  | 40 |
| HTTP Requests . . . . .  | 41 |
| HTTP Header fields . . . . .   | 42 |
| HTTP Response Codes . . . . .  | 43 |
| Client Caching . . . . .   | 44 |
| Server Redirect. . . . .   | 45 |
| Multiple simultaneous connections to server. . . . .                 | 46 |



|  |    |
|--|----|
| Problems with multiple connections.....              | 48 |
| HTTP Statistics . . . . .                            | 49 |
| What happens when you make an HTTP request . . . . . | 50 |
| HTTP Performance Problems . . . . .                  | 51 |
| HTTP performance .....                               | 52 |
| Web Enabled Devices .....                            | 53 |
| Network File System (NFS).....                       | 54 |
| Remote Procedure Call (RPC) . . . . .                | 55 |
| External Data Representation (XDR) . . . . .         | 57 |
| Port Mapper . . . . .                                | 58 |
| NFSspy . . . . .                                     | 59 |
| NFSspy problem . . . . .                             | 60 |
| nfsspy . . . . .                                     | 61 |
| NFS protocol, version 2 (RFC 1094) . . . . .         | 62 |
| NFS File Handles . . . . .                           | 64 |
| NFS Mount protocol . . . . .                         | 65 |
| NFS Procedures . . . . .                             | 66 |
| NFS over TCP . . . . .                               | 67 |
| NFS Statelessness . . . . .                          | 68 |
| X Window System .....                                | 69 |
| Low Bandwidth X . . . . .                            | 71 |
| Xscope . . . . .                                     | 72 |

|   |    |
|---|----|
| Additional tools for watching TCP ..... | 73 |
| Transaction TCP (T/TCP).....            | 75 |
| Summary .....                           | 76 |
| References .....                        | 77 |

|  |    |
|--|----|
| Module 6: SCTP .....                                     | 1  |
| Transport layer protocols .....                          | 2  |
| Stream Control Transmission Protocol (SCTP) [3] .....    | 3  |
| SCTP Applications. . . . .                               | 4  |
| SCTP Header .....  | 5  |
| SCTP Chunk .....   | 6  |
| Association establishment - <b>4-way handshake</b> ..... | 7  |
| INIT Chunk.....  | 8  |
| INIT ACK Chunk .....                                     | 10 |
| COOKIE ECHO Chunk.....                                   | 12 |
| COOKIE ACK Chunk .....                                   | 13 |
| Data Chunk .....   | 14 |
| Multiple-Streams.....                                    | 15 |
| Selective Acknowledgement (SACK) Chunk.....              | 16 |
| ERROR chunk .....  | 17 |
| Association Termination.....                             | 18 |
| Association Shutdown . . . . .                           | 19 |
| SCTP Example - Daytime [6].....                          | 21 |
| ethereal capture - daytime - INIT.....                   | 22 |
| ethereal capture - daytime - INIT-ACK.....               | 23 |
| ethereal capture - daytime - COOKIE-ECHO .....           | 24 |
| ethereal capture - daytime - COOKIE-ACK.....             | 25 |

|   |    |
|---|----|
| ethereal capture - daytime - DATA .....             | 26 |
| ethereal capture - daytime - SACK.....              | 27 |
| ethereal capture - daytime - SHUTDOWN.....          | 28 |
| ethereal capture - daytime - SHUTDOWN_ACK .....     | 29 |
| ethereal capture - daytime - SHUTDOWN_COMPLETE..... | 30 |
| Fault Management .....                              | 31 |
| HEARTBEAT and HEARTBEAT ACK Chunks.....             | 32 |
| Heartbeat and ACK.....                              | 33 |
| Differences from TCP Congestion Control .....       | 34 |
| Path MTU Discovery .....                            | 35 |
| SCTP header continued.....                          | 37 |
| Forward Cumulative TSN.....                         | 38 |
| SCTP Performance. . . . .                           | 40 |
| Transport Protocol Functional Overview.....         | 41 |
| Summary .....                                       | 42 |
| References.....                                     | 43 |

|  |    |
|--|----|
| Module 7: Dynamic Routing .....                    | 1  |
| Outline.....                                       | 2  |
| Routing.....                                       | 3  |
| Routing Principles.....                            | 4  |
| Basic Router Software Architecture .....           | 5  |
| Processing .....                                   | 6  |
| Routing packets in the Internet .....              | 7  |
| Autonomous systems (ASs) - RFC1930 [1] .....       | 8  |
| Routing Metrics .....                              | 9  |
| Routing Algorithms .....                           | 10 |
| Intradomain routing protocols.....                 | 11 |
| Routing Information Protocol (RIP) version 1 ..... | 12 |
| RIP v1 operation .....                             | 13 |
| When are routes sent? . . . . .                    | 14 |
| Problems with RIP v1 .....                         | 15 |
| Count to Infinity.....                             | 16 |
| Split Horizon.....                                 | 17 |
| Triggered updates and Hold-Downs .....             | 18 |
| RIP extensions (aka RIP-2).....                    | 19 |
| Why would anyone use RIP?.....                     | 20 |
| Interior Gateway Routing Protocol (IGRP) .....     | 21 |
| IGRP Metrics .....                                 | 22 |

|  |    |
|--|----|
| IGRP Route Poisoning .....                                     | 23 |
| IGRP Default Gateway .....                                     | 24 |
| Enhanced IGRP (EGRP) [6] .....                                 | 25 |
| Open Shortest Path First (OSPF) .....                          | 26 |
| OSPF building blocks .....                                     | 28 |
| OSPF Packets.....  | 29 |
| Hello packet .....   | 30 |
| Database Description packet.....                               | 31 |
| Link State Announcement (LSA) header.....                      | 32 |
| Link state update packet.....                                  | 34 |
| Link state request packet.....                                 | 35 |
| Link state acknowledgement packet .....                        | 36 |
| Interdomain routing protocols.....                             | 37 |
| Exterior Gateway Protocol (EGP) .....                          | 38 |
| BGP - Border Gateway Protocol.....                             | 39 |
| Local vs. Transit traffic.....                                 | 40 |
| BGP operation.....   | 41 |
| Classless Inter-Domain Routing (CIDR).....                     | 43 |
| Redistribution of Route Information<br>between protocols ..... | 44 |
| Resulting BGP Architecture .....                               | 45 |
| BGP Messages .....   | 46 |

|   |    |
|---|----|
| BGP Open Message .....                          | 47 |
| BGP Update Message .....                        | 48 |
| BGP Keepalive Message.....                      | 49 |
| BGP Notification Message .....                  | 50 |
| Interconnections of networks .....              | 51 |
| Federal Internet eXchange (FIX) .....           | 52 |
| Commercial Internet eXchange (CIX).....         | 53 |
| Global Internet eXchange (GIX) .....            | 54 |
| Some of Sweden's Internet exchange points ..... | 55 |
| Network Access Points (NAPs) .....              | 56 |
| NAPs today .....                                | 57 |
| Router Arbiter Project.....                     | 58 |
| Internet Routing Registry (IRR) .....           | 59 |
| Euro6IX.....                                    | 60 |
| Cisco's NetFlow Switching .....                 | 61 |
| Flows.....                                      | 62 |
| Cisco's Tag Switching .....                     | 63 |
| Tag Locations.....                              | 65 |
| Creating tags .....                             | 66 |
| Routers do more than routing .....              | 67 |
| Summary .....                                   | 68 |
| References .....                                | 69 |

|  |    |
|--|----|
| Module 8: Multicasting and RSVP.....                                 | 1  |
| Outline.....   | 2  |
| Multicast and IGMP.....  | 3  |
| Broadcast and Multicast.....   | 4  |
| Filtering up the protocol stack .....                                | 5  |
| Broadcasting .....   | 6  |
| Other approaches to One-to-Many and Many-to-Many communication ..... | 7  |
| Alternative centralized model.....                                   | 8  |
| Multicast Backbone (MBONE) .....                                     | 9  |
| IP Multicast scales well .....                                       | 10 |
| Core Problem .....   | 11 |
| Steve Deering's Multicast.....                                       | 12 |
| IP WAN Multicast Requirements .....                                  | 13 |
| Multicasting IP addresses .....                                      | 14 |
| Internet Multicast Addresses.....                                    | 15 |
| Converting Multicast Group to Ethernet Address .....                 | 16 |
| Mapping Multicast (Class D) address to<br>Ethernet MAC Address.....  | 17 |
| Problems .....   | 18 |
| IGMP: Internet Group Management Protocol .....                       | 19 |
| How does IGMP fit into the protocol stack .....                      | 20 |
| Joining a Multicast Group.....                                       | 21 |



|  |    |
|--|----|
| IGMP Implementation Details .....                            | 22 |
| Group membership State Transitions.....                      | 23 |
| IGMP Version 2 [3] .....                                     | 24 |
| IGMP Version 3 [4] .....                                     | 25 |
| IGMP - ethereal.....   | 26 |
| Frame 1: IGMP Membership Query .....                         | 27 |
| Frame 2: IGMP v2 Membership Report .....                     | 28 |
| Frame 12: IGMP v1 Membership Report .....                    | 29 |
| Frame 15: IGMP v2 Leave Group .....                          | 30 |
| Multicast routing.....                                       | 31 |
| Therefore a Multicast Router .....                           | 32 |
| Multicasting .....   | 33 |
| Multicast Routing - Flooding.....                            | 34 |
| Delivery Trees: different methods .....                      | 35 |
| Multicast Routing - Spanning Trees .....                     | 36 |
| Link-State Multicast: MOSPF [5].....                         | 37 |
| Reverse -Path Forwarding (RPF).....                          | 38 |
| Reverse Path Broadcast (RPB) .....                           | 40 |
| RPB + Prunes $\Rightarrow$ Reverse Path Multicast (RPM)..... | 41 |
| Distance-Vector Multicast Routing Protocol (DVMRP) [6] ..... | 42 |
| Multicast Routing - Steiner Tree's.....                      | 43 |
| Core-Based Trees (CBT) .....                                 | 44 |

|  |    |
|--|----|
| Protocol-Independent Multicast (PIM) .....           | 45 |
| Multiprotocol BGP (MBGP) [10] .....                  | 46 |
| Multicast backbone (MBONE) [2] .....                 | 47 |
| Telesys class was multicast over MBONE .....         | 48 |
| Benefits for Conferencing .....                      | 49 |
| MBONE Chronology .....                               | 50 |
| MBONE growth .....                                   | 51 |
| MBONE connections .....                              | 53 |
| mrouter .....  | 54 |
| Multicast Source Discovery Protocol (MSDP)[13] ..... | 55 |
| GLOP addressing .....                                | 56 |
| Single Source Multicast (SSM) [15] .....             | 57 |
| Other multicast efforts .....                        | 58 |
| Tools for managing multicast .....                   | 59 |
| SNMP-based tools and multicast related MIBs .....    | 60 |
| Protocol-Specific Multicast Routing MIBs .....       | 61 |
| SNMP tools for working with multicast MIBs .....     | 62 |
| QoS & Scheduling algorithms .....                    | 63 |
| RSVP: Resource Reservation Setup Protocol [19] ..... | 64 |
| Functionality .....                                  | 65 |
| Resource Reservation .....                           | 66 |
| Jitter Control .....                                 | 67 |

|                                    |    |
|------------------------------------|----|
| Capacity Assignment .....          | 68 |
| RSVP Protocol Mechanism .....      | 69 |
| RSVP Soft State .....              | 70 |
| RSVP operation .....               | 71 |
| RSVP operations (continued) .....  | 72 |
| RSVP Summary .....                 | 73 |
| Argument against Reservation ..... | 74 |
| Further reading .....              | 75 |
| Summary .....                      | 76 |
| References .....                   | 77 |

|   |    |
|---|----|
| Module 9: Applications: Network Management and VoIP ..... | 1  |
| Lecture 5: Outline .....                                  | 2  |
| ISO FCAPS Network Management Model.....                   | 3  |
| Network Management Process .....                          | 4  |
| Network Management Process .....                          | 5  |
| SNMP .....  | 6  |
| SNMPv3.....   | 7  |
| SNMP .....  | 8  |
| Management Information Base: MIB .....                    | 9  |
| Case Diagram.....   | 10 |
| SNMP Traps.....   | 11 |
| Remote MONitoring (RMON) .....                            | 12 |
| RMON Probes or Monitors.....                              | 13 |
| RMON1 Statistics .....                                    | 14 |
| Ethernet Statistics Group .....                           | 15 |
| EtherStatsEntry .....                                     | 16 |
| EtherHistoryEntry .....                                   | 17 |
| HostEntry .....   | 18 |
| Host Top N group .....                                    | 19 |
| The Matrix Group .....                                    | 20 |
| RMON2.....  | 21 |
| Proprietary MIBs to extend RMON functions.....            | 23 |

|   |    |
|---|----|
| Network Management Systems .....                          | 24 |
| WEB based Management.....                                 | 25 |
| Web Based Enterprise Management Initiative (WBEM) .....   | 27 |
| Four Elements of DMI.....                                 | 29 |
| Common Information Model (CIM).....                       | 30 |
| Java and Management.....                                  | 31 |
| Inter-domain Management task force (XoJIDM) .....         | 32 |
| Policy Based Management.....                              | 33 |
| Applications .....  | 34 |
| Voice over IP (VoIP) .....                                | 35 |
| Deregulation $\Rightarrow$ New regulations .....          | 36 |
| Deregulation continued.....                               | 37 |
| Latency.....  | 38 |
| Increasingly IP based data+voice infrastructure . . . . . | 39 |
| Voice Gateway.....  | 40 |
| Voice over IP (VOIP) .....                                | 41 |
| VOIP Modes of Operation .....                             | 43 |
| Cisco Voice Over IP .....                                 | 44 |
| Intranet Telephone System .....                           | 47 |
| Wireless LANs.....  | 48 |
| Telia's HomeRun.....                                      | 49 |
| Carriers offering VOIP .....                              | 50 |

|  |    |
|--|----|
| VOIP vs. traditional telephony .....   | 51 |
| Economics .....                        | 52 |
| Conferences.....                       | 53 |
| Patents .....                          | 54 |
| Deregulation $\Rightarrow$ Trends..... | 56 |
| VoIP details.....                      | 57 |
| RTP: Real-Time Transport Protocol..... | 58 |
| RTP and H.323 for IP Telephony .....   | 59 |
| SIP: Session Initiation Protocol ..... | 60 |
| SIP timeline.....                      | 61 |
| SIP Invite .....                       | 62 |
| Bob's response .....                   | 63 |
| SIP Methods.....                       | 64 |
| SIP Status codes .....                 | 65 |
| ENUM.....                              | 66 |
| Further Reading .....                  | 67 |
| Web Services .....                     | 68 |
| Twitter.....                           | 69 |
| Summary .....                          | 70 |
| References.....                        | 71 |

|   |    |
|---|----|
| Module 10: IPv6 .....                                       | 1  |
| Lecture 6: Outline .....                                    | 2  |
| Internet Protocol Version 6 (IPv6).....                     | 3  |
| Growth .....  | 4  |
| Nomadic Computing .....                                     | 5  |
| Networked Entertainment .....                               | 6  |
| Device Control.....   | 7  |
| IPv6 features .....   | 8  |
| IPv6 header format.....                                     | 9  |
| Demultiplexing .....  | 10 |
| Simplifications .....                                       | 11 |
| Quality-of-Service Capabilities .....                       | 12 |
| Payload length.....   | 13 |
| IPv4 Protocol type $\Rightarrow$ IPv6 Next Header type..... | 14 |
| Extension headers .....                                     | 15 |
| Addressing .....  | 16 |
| Writing an IPv6 address.....                                | 17 |
| Address Allocation [17] and [22] .....                      | 18 |
| Global Unicast Addresses .....                              | 19 |
| Interface ID .....  | 21 |
| Special Address Formats.....                                | 22 |
| Unspecified address . . . . .                               | 22 |

|   |    |
|---|----|
| Loop-back address . . . . .                   | 22 |
| IPv4-based address. . . . .                   | 22 |
| Site local addresses . . . . .                | 22 |
| Link local addresses. . . . .                 | 23 |
| Multicast Addresses . . . . .                 | 24 |
| Permanently assigned groups.....              | 25 |
| Prefix for IPv6 documentation.....            | 27 |
| Anycast . . . . .                             | 28 |
| IPv6 Routing . . . . .                        | 29 |
| Routing header.....                           | 30 |
| Fragment header.....                          | 31 |
| Destination Options header.....               | 32 |
| Hop-by-Hop Options header.....                | 34 |
| Security . . . . .                            | 35 |
| IPSEC IPv6 implementation . . . . .           | 36 |
| IPv6 ICMP [13] . . . . .                      | 37 |
| IPv6 ICMP Error Messages . . . . .            | 38 |
| IPv6 ICMP Echo Request/Reply (PING) . . . . . | 39 |
| IPv6 ICMP and groups.....                     | 40 |
| Summary of IPv6 ICMP . . . . .                | 41 |
| DNS and IPv6 . . . . .                        | 42 |
| IPv6 Transition Mechanisms . . . . .          | 43 |



|   |    |
|---|----|
| Why IPv6? .....   | 44 |
| IPv6 networks .....   | 45 |
| RIR assignments of IPv6 addresses .....   | 46 |
| If things are to be connected they need to be addressable $\Rightarrow$ IPv6..... | 47 |
| Migration to IPv6.....  | 48 |
| Where are ISPs? .....   | 49 |
| Further information.....  | 50 |
| Summary .....   | 51 |
| References.....   | 52 |

|  |    |
|--|----|
| Module 11: Mobile IP.....  | 1  |
| Outline.....   | 2  |
| Emerging Network Architecture.....   | 3  |
| Mobility . . . . .   | 4  |
| Updating after a move.....   | 5  |
| Objectives of Mobile IP .....  | 6  |
| Communication from Z to X . . . . .  | 7  |
| How can Z continue to communication to X? . . . . .                          | 8  |
| Identification . . . . .   | 9  |
| Establishing Identity . . . . .  | 10 |
| How did it know to send the “I am” message to the MSR? . . . . .             | 11 |
| Could the MSR functionality be collocated with the router? . . . . .         | 12 |
| Getting Service. . . . .   | 13 |
| Back to the original problem: Z wants to send a message to X. . . . .        | 14 |
| Alternative 1. . . . .   | 15 |
| Alternative 2. . . . .   | 16 |
| Alternative 3. . . . .   | 17 |
| Alternative 4. . . . .   | 18 |
| Alternative 4 continued . . . . .  | 19 |
| How does Z know to send things to <b>MSR-<math>\alpha</math></b> ? . . . . . | 20 |
| What happens in the case of wireless networks? . . . . .                     | 21 |
| Wireless Local Area Networks . . . . .                                       | 22 |

|   |    |
|---|----|
| Wireless WANs .....                                       | 23 |
| Simulcasting in Wireless Local Area Networks (WLANs)..... | 24 |
| Mobile IP Standardization Effort.....                     | 25 |
| A Mobile-IP(V4) Scenario.....                             | 26 |
| A Mobile-IP(V6) Scenario.....                             | 27 |
| IP-in-IP Encapsulation .....                              | 28 |
| Tunneling IP Datagrams .....                              | 29 |
| Temporary Address Assignment.....                         | 30 |
| Agent Discovery .....                                     | 31 |
| Agent Advertisement Message Format.....                   | 32 |
| Registration Message Format .....                         | 33 |
| MN Requirements .....                                     | 34 |
| FA Requirements (v4).....                                 | 35 |
| HA Requirements.....                                      | 36 |
| Optimization Problem.....                                 | 37 |
| Problems of Mobile IP (RFC2002).....                      | 38 |
| Mobile IP Problems and Development .....                  | 39 |
| CDMA2000 Extension to Mobile IP .....                     | 40 |
| Wireless IP Network Architecture .....                    | 41 |
| Cellular IP (CIP) .....                                   | 42 |
| Cellular IP (CIP): Handover .....                         | 43 |
| Cellular IP (CIP): Location Update .....                  | 44 |

|  |    |
|--|----|
| Hierarchical FA and Regional Tunneling ..... | 45 |
| Hierarchical FA and Regional Tunneling ..... | 46 |
| Hierarchical FA and Regional Tunneling ..... | 47 |
| Why not simply use Dynamic DNS (DDNS)? ..... | 48 |
| Summary .....                                | 49 |
| References .....                             | 50 |

|  |    |
|--|----|
| Module 12: IPSec, VPNs, Firewalls, and NAT ..... | 1  |
| Outline.....                                     | 2  |
| Private networks.....                            | 3  |
| Virtual Private networks (VPNs) .....            | 4  |
| Security Protocols, APIs, etc. ....              | 5  |
| GSS-API .....                                    | 6  |
| IPSec .....                                      | 7  |
| ESP packet .....                                 | 8  |
| AH header .....                                  | 9  |
| ISAKMP .....                                     | 10 |
| Where can you run IPSec? .....                   | 11 |
| Firewalls.....                                   | 12 |
| Linux firewall.....                              | 13 |
| Firewall Design.....                             | 14 |
| Proxy Access Through A Firewall.....             | 15 |
| SOCKs .....                                      | 16 |
| Newping.....                                     | 17 |
| MBONE through firewalls.....                     | 18 |
| Secure Mailer (aka Postfix) .....                | 19 |
| U.S. DOE CIAC's Network Security Tools [19]..... | 20 |
| The Network Mapper (NMAP).....                   | 22 |
| Network Address Translation .....                | 23 |

|  |    |
|--|----|
| Demilitarized zone (DMZ) .....             | 24 |
| Network Security Exercises .....           | 25 |
| Security Organizations and Companies ..... | 26 |
| Summary .....                              | 27 |
| Further information .....                  | 28 |
| NAT - - - - -                              | 30 |

|  |    |
|--|----|
| Module 13: Future and Summary .....  | 1  |
| Outline.....   | 2  |
| Generations of technology versus<br>generative technology .....                  | 3  |
| Third generation of networking .....   | 4  |
| Dissemination <u>not</u> conversation.....                                       | 5  |
| From PANs to RANs and beyond.....  | 6  |
| Are interplanetary and intergalactic networks relevant to you? .....             | 7  |
| Delay Tolerant Networks (DTNs) .....   | 8  |
| Trends: Shifting from traditional telecommunications to data communications..... | 9  |
| Growth rates.....  | 10 |
| Visualizing these laws.....  | 11 |
| Growth in Internet hosts.....  | 12 |
| Exponential growth.....  | 13 |
| Long tail .....  | 14 |
| Is this only true for books?.....  | 15 |
| Free .....   | 16 |
| Too cheap to meter.....  | 17 |
| Working for free .....   | 18 |
| What Would Google Do?.....   | 19 |
| Quality of Service (QoS) .....   | 20 |
| Service Differentiation.....   | 21 |

|  |    |
|--|----|
| Constraint-based Routing.....                        | 22 |
| Mobile <i>ad hoc</i> Networks (MANETs) .....         | 23 |
| Performance .....                                    | 24 |
| Routers: - - - - -                                   | 24 |
| PC interfaces .....                                  | 25 |
| Fibre Channel.....                                   | 26 |
| IP Storage Area Networks (SANs) .....                | 27 |
| Clustering.....                                      | 30 |
| “Beowulf-class” machines .....                       | 31 |
| Very high-speed Backbone Network Service (vBNS)..... | 32 |
| Internet2 .....                                      | 33 |
| Gigapops .....                                       | 34 |
| Speed through Silicon.....                           | 35 |
| Future networks .....                                | 36 |
| Active Networks .....                                | 37 |
| Active networks .....                                | 38 |
| Smart Networks with Sensors.....                     | 39 |
| Internetworking as the future? .....                 | 40 |
| Future of the Internet .....                         | 41 |
| Counter currents.....                                | 42 |
| Clean slate re-design of the Internet .....          | 43 |
| Implicit vs. Explicit Information.....               | 44 |
| Is an hourglass the right model? .....               | 45 |



|  |    |
|--|----|
| Peer to peer networking .....                    | 46 |
| Wikinomics .....                                 | 47 |
| Resource pooling .....                           | 48 |
| Resource pooling examples .....                  | 49 |
| Context of the module.....                       | 50 |
| What kinds of things might be interesting? ..... | 51 |
| Personal monitoring .....                        | 52 |
| Vehicle Area Networks (VANs).....                | 53 |
| Vehicular <i>ad hoc</i> networks (VANETs).....   | 54 |
| Packages.....                                    | 56 |
| Buildings .....                                  | 57 |
| Appliances.....                                  | 58 |
| Infrastructure.....                              | 59 |
| Environment.....                                 | 60 |
| Is saying “Internet of xxx” misleading?.....     | 61 |
| Trossen’s Tussle Internet .....                  | 62 |
| Bottlenecks.....                                 | 63 |
| Near Future systems.....                         | 64 |
| Evolution of new varieties of networks .....     | 65 |
| Situational awareness and Adaptability .....     | 66 |
| Location Dependent service(s) .....              | 67 |
| Human centered .....                             | 68 |

|  |    |
|--|----|
| Requirements .....   | 69 |
| Dumb Badge, Smart Badge, and Intelligent Badge .....                       | 70 |
| Badge Communications Model.....  | 71 |
| Smart Badge 3 .....  | 72 |
| Smart Badge Sensors .....  | 73 |
| Badge 3 .....  | 74 |
| A view of the packaged badge .....   | 75 |
| MEDIA .....  | 76 |
| Split the functions between access point and access point server . . . . . | 77 |
| Future home/office/... network accesspoints.....                           | 78 |
| Personal Computing and Communication (PCC) .....                           | 79 |
| Uploading ourselves to the net.....  | 80 |
| Future Systems.....  | 81 |
| Bionic Technologies, Inc.'s Intracortical Electrode Array .....            | 82 |
| Non-metalic bi-directional neural interfaces .....                         | 83 |
| What is <b>your</b> time line? .....                                       | 84 |
| Spotting trends at 1% .....  | 85 |
| Summary .....  | 86 |
| Further Reading .....  | 87 |
| Thanks.....  | 91 |

|                                   |   |
|-----------------------------------|---|
| Module 14: Some exercises .....   | 1 |
| Internets - configuration 1 ..... | 2 |
| Internets - configuration 2.....  | 3 |
| Internets - configuration 3.....  | 4 |
| Internets - configuration 4.....  | 5 |
| Internets - configuration 5.....  | 6 |
| Configuration 6 .....             | 7 |
| Configuration 7 .....             | 8 |

# IK1550 Internetworking/Internetteknik

## Spring 2010, Period 4

### Module 1: Introduction

Lecture notes of G. Q. Maguire Jr.



KTH Information and  
Communication Technology

© 2010 G.Q.Maguire Jr. .

All rights reserved. No part of this course may be reproduced, stored in a retrieval system, or transmitted, in any form or by any means, electronic, mechanical, photocopying, recording, or otherwise, without written permission of the author.

Last modified: 2010.03.21:17:38

# Welcome to the Internetworking course!

The course should be [fun](#).

We will dig deeper into the TCP/IP protocols and protocols built upon them.

Information about the course is available from the course web page:

<http://www.ict.kth.se/courses/IK1550/>

The best is to always look at the link from <http://web.ict.kth.se/~maguire>

# Staff Associated with the Course

Instructor (Kursansvarig)

prof. Gerald Q. Maguire Jr. <maguire at kth.se>

# Goals, Scope and Method

## Goals of the Course

- To give deep knowledge and competence (*designing, analyzing, and developing*) of Internet protocols and architecture, both practical and analytical.
- To be able to read and understand the Internet standardization documents (IETF RFCs and Internet Drafts) and current Internet literature.
- You should have the knowledge and competence to do exciting Internet related research and development.

## Scope and Method

- Dig deeper into the TCP/IP protocol suite by using diagnostic tools to examine, observe, and analyze these protocols in action.  
Understanding the details!
- Demonstrate this by writing a written report.

# Aim

This course will give both practical and general knowledge on the **protocols** that are the basis of the Internet. After this course you should have a good knowledge about Internet protocols and internetworking architecture. You should have a general knowledge aiding you in reading research and standardization documents in the area.



# Learning Outcomes

Following this course a student should be able to:

- Understand the principles on which internetworking is based - which define the Internet (both what it is and why it has proven to be so successful)
- Understand TCP/IP protocol stack, layering, encapsulation and multiplexing
  - Understand multiplexing, demultiplexing, upward and downward multiplexing
  - Encapsulation as used for Mobile IP, Virtual Private Networks (VPNs), IP security, ... and other tunnelling protocols
  - Understand how information is encoded in headers and how the choice of this encoding and field size may effect the use and evolution of a protocol
  - Understand how data is encoded in the body of a packet and how this may effect internetworking - especially in the presence of firewall and network address translators.
- Understand IP Addressing, subnetting and address resolution - including the interaction of protocols across layers
- Understand a number of higher layer protocols including the security risks and performance limitations of each

- Understand the basic details of routing and routing protocols (RIP, BGP, OSPF) - with an emphasis on their limitations and behaviors
- Understand autoconfiguration and naming (BOOTP, DHCP, DNS, DDNS, DNSsec, ENUM, ... ) - with an emphasis on risks, limitations, scaling, and evolution
- Understand the nature and pressures on the design and operations of internets - particularly on scaling, performance, delay bounds, due to new Internet applications (VoIP, streaming, games, peer-to-peer, etc.
- Understand the advantages and disadvantages of IPv6 (in comparison to IPv4)
- Read the current literature at the level of conference papers in this area.
  - While you may not be able to understand all of the papers in journals, magazines, and conferences in this area - you **should** be able to read 90% or more of them and have good comprehension. In this area it is especially important that develop a habit of reading the journals, trade papers, etc. *In addition, you should also be aware of both standardization activities, new products/services, and public policy in the area.*
- Demonstrate knowledge of this area in writing.
  - By *writing* a paper suitable for submission to a trade paper or national conference in the area.

# Prerequisites

- Datorkommunikation och datornät/Data and computer communication **or**
- Equivalent knowledge in Computer Communications (this requires permission of the instructor)

# Contents

This course will focus on the **protocols** that are the fundamentals of the Internet. We will explore what internetworking means and what it requires. We will give both practical and more general knowledge concerning the Internet network architecture.

The course consists of 14 hours of lectures (combined with 14 hours of recitations (övningar)), and 40-100 hours of written assignment.

# Topics

- What an internet is and what is required of protocols to allow internetworking
- details of routing and routing protocols (RIP, BGP, OSPF, ...)
- multicasting
- Domain Name System (DNS, Dynamic DNS)
- what happens from the time a machine boots until the applications are running (RARP, BOOTP, DHCP, TFTP)
- details of the TCP protocols and some performance issues
- details of a number of application protocols (especially with respect to distributed file systems)
- network security (including firewalls, AAA, IPSec, SOCKs, ... )
- differences between IPv6 and IPv4
- network management (SNMP) and
- We will also examine some emerging topics:
  - cut-through routing, tag switching, flow switching, QoS, Mobile IP, Voice over IP, SIP, NAT, VPN, Diffserv, ... .

# Examination requirements

- Written assignment (6 ECTS credits)
  - based on lectures, recitations, and your references

# Grades: A..F (ECTS grades)

- To get an "A" you need to write an outstanding or excellent paper.
- To get a "B" you need to write a very good paper, i.e., it should be either a very good review or present a new idea.
- To get a "C" you need to write a paper which shows that you understand the basic ideas underlying internetworking and that you understand one (or more) particular aspects at the level of an average undergraduate student in the area.
- To get a "D" you need to demonstrate that you understand the basic ideas underlying internetworking, however, your depth of knowledge is shallow in the topic of your paper.
- If your paper has some errors (including **incomplete references**) the grade will be an "E".
- If your paper has serious errors the grade will be an "F".

If your paper is close to passing, but not at the passing level, then you will be offered the opportunity for "komplettering", i.e., students whose written paper does not pass can submit a revised version of their paper (or a completely new paper) - which will be evaluated.

# Ethics, Rights, and Responsibilities

There is a policy of zero tolerance for **cheating, plagiarism, etc.** - for details see

[http://www.kth.se/dokument/student/student\\_rights.pdf](http://www.kth.se/dokument/student/student_rights.pdf)

See also the KTH Ethics Policies at:

<http://www.kth.se/info/kth-handboken/I/7/1.html>

See the book: Jude Carroll and Cal-Mikael Zetterling, Guiding students away from plagiarism, KTH Learning Lab, 2009, ISBN 987-91-7415-403-0

<http://www.kth.se/vil/learninglab/plagiat>



# Written Assignment

Goal: to gain analytical or practical experience and to show that you have mastered some Internetworking knowledge.

- Can be done in a group of **1 to 3** students (formed by yourself). Each student must contribute to the final report.
- There will be one or more suggested topics, additional topics are possible (discuss this with one of the teachers **before** starting).

# Assignment Registration and Report

- Registration: **Wednesday 05-May-10**, to <maguire@kth.se>
  - "Subject: IK1550 topics"
  - Group members, leader.
  - Topic selected.
- Final report
  - The report should clearly describe: 1) what you have done; 2) if you have done some implementation and measurements you should describe the methods and tools used, along with the test or implementation results, and your analysis.
  - The length of the final report should be 7-8 pages for each student (detailed measurements, configuration scripts, etc. can be in additional pages as an appendix or appendices). <sup>1</sup>
  - Contribution by each member of the group - must be clear

Final Report: written report due before **Friday 28-May-10 at 23:59**

- Send email with URL link to a **PDF** file to <maguire@kth.se>
- Late assignments will not be accepted (i.e., there is no guarantee that they will be graded in time for the end of the term)

Note that it is permissible to start working *well in advance* of the deadlines!

---

1. Papers which are longer than 8 pages per student will have a maximum grade of "E".

# Literature

The course will mainly be based on the book: James F. Kurose and Keith W. Ross, *Computer Networking: A Top-Down Approach*, Fifth Edition, Pearson, 2010, ISBN-13: 978-0-13-136548-3, ISBN-10: 0-13-136548-7

Formerly the course used: Behrouz A. Forouzan, *TCP/IP Protocol Suite*, 3rd edition, McGraw-Hill, publication date January 2005, (Copyright 2006) 896 pages, ISBN 0072967722 (hardbound) or 0071115838 (softbound)

Other additional references include:

- *TCP/IP Illustrated, Volume 1: The Protocols* by W. Richard Stevens, Addison-Wesley, 1994, ISBN 0-201-63346-9 and *Internetworking with TCP/IP: Principles, Protocols, and Architectures, Vol. 1*, by Douglas E. Comer, Prentice Hall, 4th ed. 2000, ISBN 0-13-018380-6.
- the commented source code in *TCP/IP Illustrated, Volume 2: The Implementation* by Gary R. Wright and W. Richard Stevens, Addison-Wesley, 1995, ISBN 0-201-63354-X

- *IPv6: The New Internet Protocol*, by Christian Huitema, Prentice-Hall, 1996, ISBN 0-13-241936-X.
- concerning HTTP we will refer to *TCP/IP Illustrated, Volume 3: TCP for Transactions, HTTP, NNTP, and the UNIX Domain Protocols*, Addison-Wesley, 1996, ISBN 0-201-63495-3.

With regard to **Mobile IP** the following two books are useful as additional sources:

- *Mobile IP: Design Principles and Practices* by Charles E. Perkins, Addison-Wesley, 1998, ISBN 0-201-63469-4.
- *Mobile IP: the Internet Unplugged* by James D. Solomon, Prentice Hall, 1998, ISBN 0-13-856246-6.

*Internetworking Technologies Handbook* by Kevin Downes (Editor), H. Kim Lew, Steve Spanier, Tim Stevenson (Online:

[http://www-fr.cisco.com/univercd/cc/td/doc/cisintwk/ito\\_doc/index.htm](http://www-fr.cisco.com/univercd/cc/td/doc/cisintwk/ito_doc/index.htm))

We will refer to other books, articles, and RFCs as necessary. In addition, there will be **compulsory** written exercises.

# Lecture Plan

Subject to revision!

- Lecture 1: Introduction and IP basics
- Lecture 2: IP and ICMP
- Lecture 3: User Datagram Protocol (UDP) & TCP
- Lecture 4: TCP and SCTP
- Lecture 5: Dynamic Routing
- Lecture 6: IP Multicast and Mobile IP
- Lecture 7: Internet Security, VPNs, Firewalls, and NAT  
Future Issues and Summary

# Context of the course

“The network called the Internet is the single most important development in the communications industry since the public switched voice network was constructed...”

-- John Sidgmore  
when he was CEO, UUNET Technologies  
and COO, WorldCom<sup>1</sup>

---

1. <http://www.lucent.com/enterprise/sig/exchange/present/slide2.html> {this URL no longer functions}

# Context of the module

Communication systems have been both increasing their **number of users** and **increasing the variety** of communication systems. Additionally, increasingly communicating entities are *not* people, but rather **things**.

|                     | Number                            |   |
|---------------------|-----------------------------------|---|
| Micro controllers   | $6 \times 10^9$ per year          | <a href="http://doi.ieeecomputersociety.org/10.1109/MM.2002.10015">http://doi.ieeecomputersociety.org/10.1109/MM.2002.10015</a>   |
| People              | $6.7 \times 10^9$                 | <a href="http://en.wikipedia.org/wiki/World_population">http://en.wikipedia.org/wiki/World_population</a>   |
| Mobile subscribers  | $\sim 4 \times 10^9$              | <a href="http://www.itu.int/ITU-D/ict/newslog/Worldwide+Mobile+Cellular+Subscribers+To+Reach+4+Billion+Mark+Late+2008.aspx">http://www.itu.int/ITU-D/ict/newslog/Worldwide+Mobile+Cellular+Subscribers+To+Reach+4+Billion+Mark+Late+2008.aspx</a> |
| PCs                 | $> 1 \times 10^9$                 | <a href="http://www.gartner.com/it/page.jsp?id=703807">http://www.gartner.com/it/page.jsp?id=703807</a>   |
| Automobiles         | $53 \times 10^6$ produced in 2007 | <a href="http://oica.net/category/production-statistics/">http://oica.net/category/production-statistics/</a>   |
| Commercial vehicles | $20 \times 10^6$ produced in 2007 | <a href="http://oica.net/category/production-statistics/">http://oica.net/category/production-statistics/</a>   |

# From PANs to RANs and beyond

The communication range of users - range from  $\sim 10^{-3}$  m to  $\gg 10^6$  m:

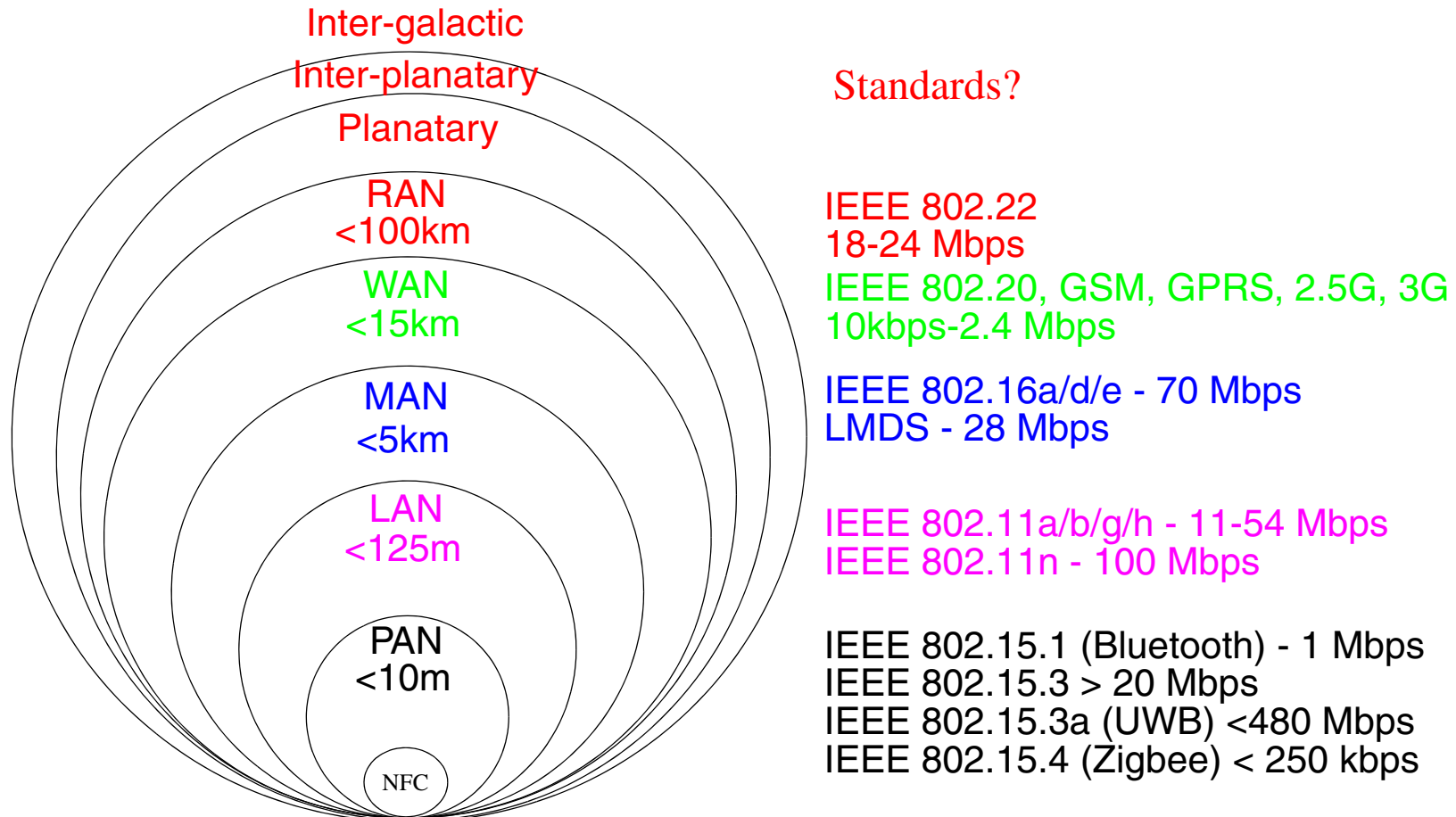

Figure 1: From Personal Area Networks (PANs) to Regional Area Networks (RANs) inspired by slide 5 of [24]

⇒ This implies that solutions will involve **heterogeneous** networks.



# How can we deal with all of these different networks?

- Force a **single winner**
  - Use a single network **architecture**
    - Everything will be ATM
    - Everything will be UMTS
    - ...
  - Use a single network **protocol**
    - IP
    - IPX
    - SNA
    - ...
- Live with **multiple winners**
  - Specialized networks: a circuit switched PSTN, a cable TV network, ...
  - Niche networks: local point to point links (such as IRDA, Bluetooth, ...), RFID, ...

# Internetworking

Internetworking is

- based on the interconnection (concatenation) of multiple networks
- accommodates multiple underlying hardware technologies by providing a way to interconnect **heterogeneous** networks and makes them inter-operate - via **a common network layer**.

These interconnections have technical, political, and regulatory effects.

⇒ Rise of truly **international** operators - one **logical** network independent of geography (independent of the fact that it is built of multiple cooperating & competing networks)

# Basic concepts

## open-architecture networking

- Each distinct network stands on its own makes its own technology choices, etc. ⇒ no changes within each of these networks in order to internet
- Based on best-effort delivery of datagrams
- Gateways interconnect the networks
- No global control

## The End2End Argument

Some basic design principle for the Internet:

- Specific application-level functions should **not** be built into the lower levels
- Functions implemented **in** the network should be simple and general.
- Most functions are implemented (as software) at the edge  
⇒ complexity of the core network is reduced  
⇒ increases the chances that new applications can be easily added.

See also [5],[6]

## Hourglass (Stuttgart wineglass) Model

- Anything over IP
- IP over anything

Note the broad (and open) top - enabling lots and lots of application

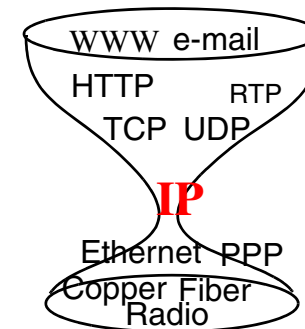

# How does this avoid the “B-ISDN debacle”?

Internetworking is completely different from the B-ISDN:

- Rather than a single cell based circuit switched network - the focus is on **interconnecting networks** via a common network layer protocol
- **Lots of products** and **lots of vendors** selling these products
  - note: there is significant competition with a very fast development cycle
- The technology is “**good enough**” vs. trying to be an improved version of ISDN (think of examples from Clayton Christianson’s *The Innovator’s Dilemma: When New Technologies Cause Great Firms to Fail* [23])
- It exploits the very rapid advances at the **edge of the network** - which *the users pay for!*
- Encourages both **cooperation** by different network operators and **competition** between different network operators!

⇒ network connectivity as a **commodity** using commodity products to deliver a wide range of **services**

# Internetworked Architecture

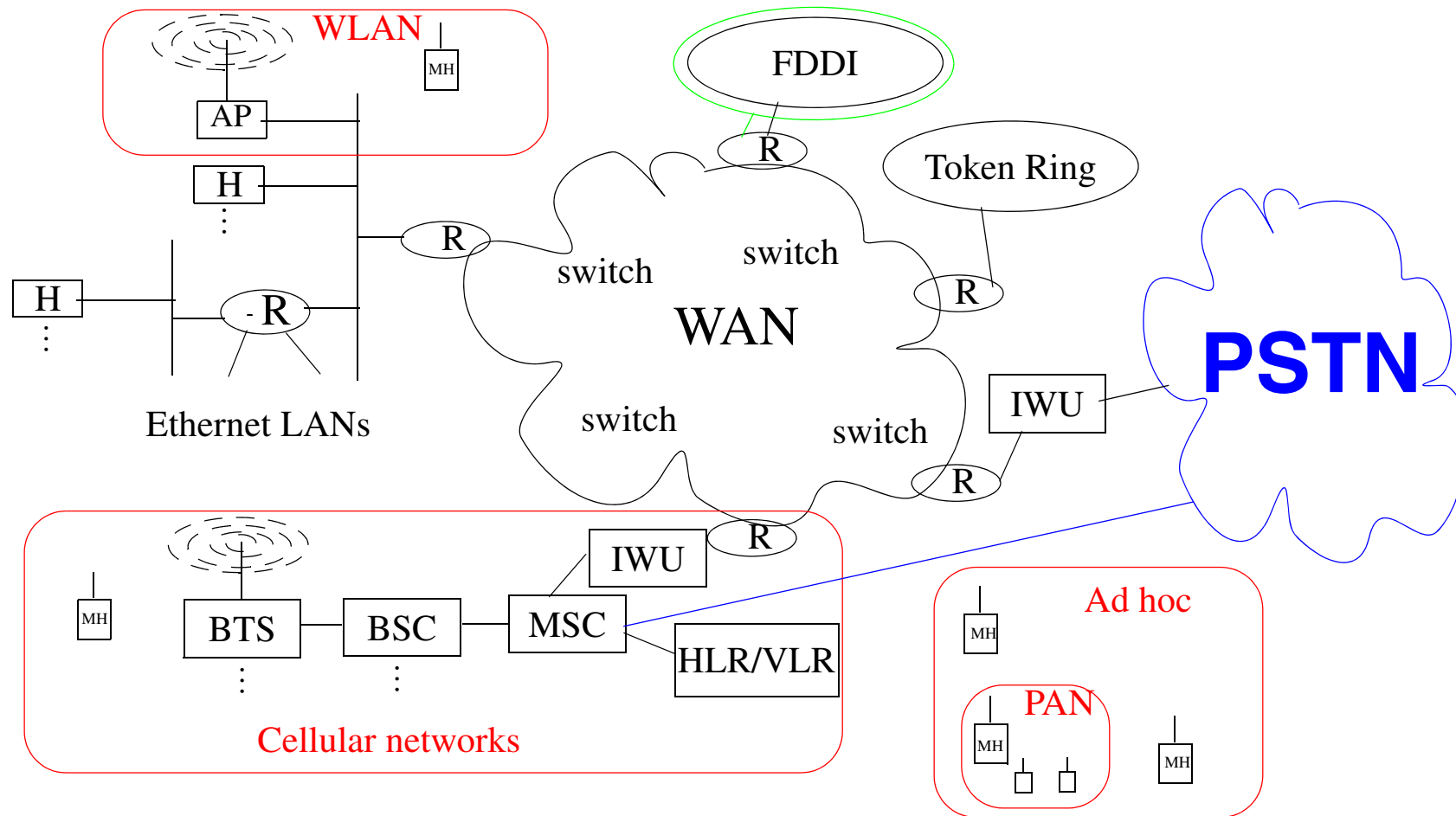

Figure 2: Internet and PSTN  $\Rightarrow$  Multiple network technologies - *internetworked* together

- Facilitates **disaggregation** - since **functionality** can be located anywhere on the internet
- Note that some of the routers act as **gateways** between different types of networks.

# Internet Trends

- **Numbers** of users and internet devices increases very rapidly
  - Network Wizards' Internet Domain Survey - <https://www.isc.org/solutions/survey>  
July 2009: 681,064,561; Jan. 2008: 541,677,360; Jan. 2005: 317,646,084 hosts
  - RIPE's survey hosts: IPv4: 253,335,713, IPv6: 58,321 (Jan. 2010)
  - RIPE's survey - Sweden: IPv4: 5,676,447, IPv6: 3,595 (Jan. 2010)
    - Estimates are based on DNS information; <http://www.ripe.net/is/hostcount/>
    - Network Weather Maps - <http://www.cybergeography.org/atlas/weather.html>  
<http://www.nordu.net/stat-g/load-map/ndn-map,,traffic,busy>
- **QoS**: Demand for integrating many different types of traffic, such as video, audio, and data traffic, into one network ⇒ **Multicast, IPv6, RSVP, DiffServ**, emphasis on **high performance**, and **TCP extensions**
- **Mobility**: both users and devices are mobile
  - There is a difference between **portable** (bärbar) vs. **mobile** (mobil).
  - IP is used in wireless systems (for example 3G cellular).
  - Increasing use of wireless in the last hop (WLAN, PAN, Wireless MAN, ...)
- **Security**:
  - Wireless mobile Internet - initial concern driven by wireless link
  - Fixed Internet - distributed denial of service attacks, increasing telecommuting, ...

# Trends: Shifting from traditional telecommunications to data communications

This is often referred to as the shift to "All-IP" networking.

This embodies:

- A shift from **circuit-switched** to **packet-switched**
  - such as: from Intelligent network (IN) to IP Multimedia Core Network Subsystem (IMS)
- Introduction of new technologies:
  - Voice over IP (VoIP)
  - Number portability
  - Context-awareness (including location-awareness) in services
- From services being what the **telecommunication operator** offers *to you* to what **anyone** offers to you. This is accompanied by a major shift in:
  - How services are created
  - Where services are provisioned
  - Where data is stored and who stores it
- Desperate efforts to retain **control, market share, high profits, access to phone numbers, and call contents, ...** - the genie is reluctant to go back into the bottle!

# Power of the Internet (chaos)

“Historically, the Internet has been an environment in which to experiment. There have been a few basic rules. The most important is the standard for IP and TCP.

There are other important standards for promulgating routing information and the like, but the real power of the Internet idea is that there are not mandated standards for what can run over the ‘Net.

Anyone who adheres to TCP/IP standards can create applications and run them without getting anyone’s permission. No ISP even has to know you are experimenting (or playing, which is also OK). This freedom produces unpredictable results. New industries can be created almost overnight and existing industries severely affected.  
...”

-- Scott O. Bradner, “The Importance of Being a Dynamist”,  
Network World, December 13, 1999, p. 48 ([www.nwfusion.com](http://www.nwfusion.com))



# IP traffic growing exponentially!

## Traffic increasing (but **not** due to voice)

- IP traffic between US and Sweden many times the total voice+FAX traffic
- many Gbit/s transatlantic fiber

## Fixed Links - arbitrarily fast:

- LANs: 10Mbits/s, 100Mbits/s, 1Gbits/s, 10Gbits/s, 40Gbits/s, ...
- Backbones: Gigabits/s  
Transoceanic fibers between continents  $\Rightarrow$  Gbit/s  $\Rightarrow$  Tbit/s
- Major sites link to backbones: increasingly 100<sup>+</sup>Mbit/s to 10 Gbit/s
- Individual users links:  $\Rightarrow$  xDSL (2 Mbits/s .. 100 Mbits/s), ethernet (10/100/1000)

## Points of Presence (PoPs) + FIX/CIX/GIX/MAE<sup>1</sup> $\Rightarrow$ GigaPoPs

(George) Guilder's Law states that network speeds will **triple every year for the next 25 years**. This dwarfs Moore's law that predicts CPU processor speed will double every 18 months.

---

1. Federal Internet eXchange (FIX), Commercial Internet eXchange (CIX), Global Internet eXchange (GIX), Metropolitan Access Exchange (MAE)

# Speed

“... The Internet world moves fast. The integration of voice and data onto a single network is not being lead by the International Telecommunications Union or by Bellcore. Rather, its being lead by entrepreneurs like .... Until now, the voice networks dominated. Data could ride on top of the phone network -- when it was convenient. The explosion of data networking and Internet telephony technology is making the opposite true. Now voice can ride on data networks -- when it is convenient.”<sup>1</sup>

Because of bandwidth constraints, Internet telephony would not be a major factor **“for a long time -- maybe nine to twelve months.”**

-- president of a major ISP<sup>2</sup>

**Internet time - 7x real time**

-- Ira Goldstein, HP

---

1. from <http://www.dialogic.com/solution/internet/apps.htm> {no longer a valid URL}

2. from <http://www.dialogic.com/solution/internet/apps.htm> {no longer a valid URL}

# Growth rates

Some people think the Internet bandwidth explosion is relatively recent, but right from the beginning it's been a race against an ever-expanding load. It isn't something you can plan for. In fact, the notion of long-range planning like the telcos do is almost comical. Just last month, a local carrier asked us why we didn't do five-year plans, and we said, "We do-about once a month!"

-- Mike O'Dell<sup>1</sup> VP and Chief Technologist UUNET

Mike points out that the growth rate of the Internet is driven by the increasing speed of computers, while telcos have traffic which was proportional to the growth in numbers of people (each of whom could only use a very small amount of bandwidth).

- by 1997 UUNET was adding at least one T3/day to their backbone (this **growth** was 45Mb/s/day)

---

1. from [http://www.data.com/25years/mike\\_odell.html](http://www.data.com/25years/mike_odell.html) {no longer a valid URL}

# ¿Question?

“Which would you rather have twice as fast:  
your computer’s processor or modem?”

After 30 years of semiconductor doublings under Moore’s Law, processor speed are measured in megahertz. On the other hand, after 60 years of telco’s snoozing under monopoly law, modem speeds are measure in kilobits. Modems are way too slow for Internet access, but you knew that.”<sup>1</sup>

-- Bob Metcalfe, inventor of Ethernet in 1973

---

1. “From the Ether: Moving intelligence and Java Packets into the Net will conserve bandwidth”, by Bob Metcalfe, Inforworld, Oct., 6, 1997, pg. 171.

# Increasing Data Rates

## “Ethernet”

- 3 Mbps Ethernet (actually 2.944 Mbits/sec)
- 10 Mbps Ethernet (which became IEEE 802.3)
- 100 Mbps Ethernet (100Tx)
- Gigabit Ethernet (IEEE 802.3z, IEEE 802.3ab)
- 10 GbE (IEEE 802.3ae), 40GbE, and 100GbE

## Optical

- Dense Wavelength Division Multiplexing (DWDM) - allowing 1000s of multi-Gbits/s channels to be carried on existing fibers

## Wireless

- UMTS (with HSPA ~10Mbits/s) and LTE (100 Mbits/s)
- IEEE 802.11 Wireless LAN (2 .. 100 Mbits/s)
- IEEE 802.15 Wireless Personal Area Network (WPAN)
- IEEE 802.16 Metropolitan Area Networks - Fixed Broadband Wireless

The "Get IEEE 802®" program makes their standards available on-line: <http://standards.ieee.org/getieee802/index.html>

# Internetworking

Internetworking is

- based on the interconnection (concatenation) of multiple networks
- accommodates multiple underlying hardware technologies by providing a way to interconnect **heterogeneous** networks and makes them inter-operate.

We will concern ourselves with one of the most common internetworking protocols IP (there *are* other internetworking protocols, such as Novell's Internetwork Packet Exchange (IPX), Xerox Network Systems (XNS), IBM's Systems Network Architecture (SNA), OSI's ISO-IP).

We will examine both IP:

- version 4 - which is in wide use
- version 6 - which is coming into use

Internet: the worldwide internet

# The Internet Today

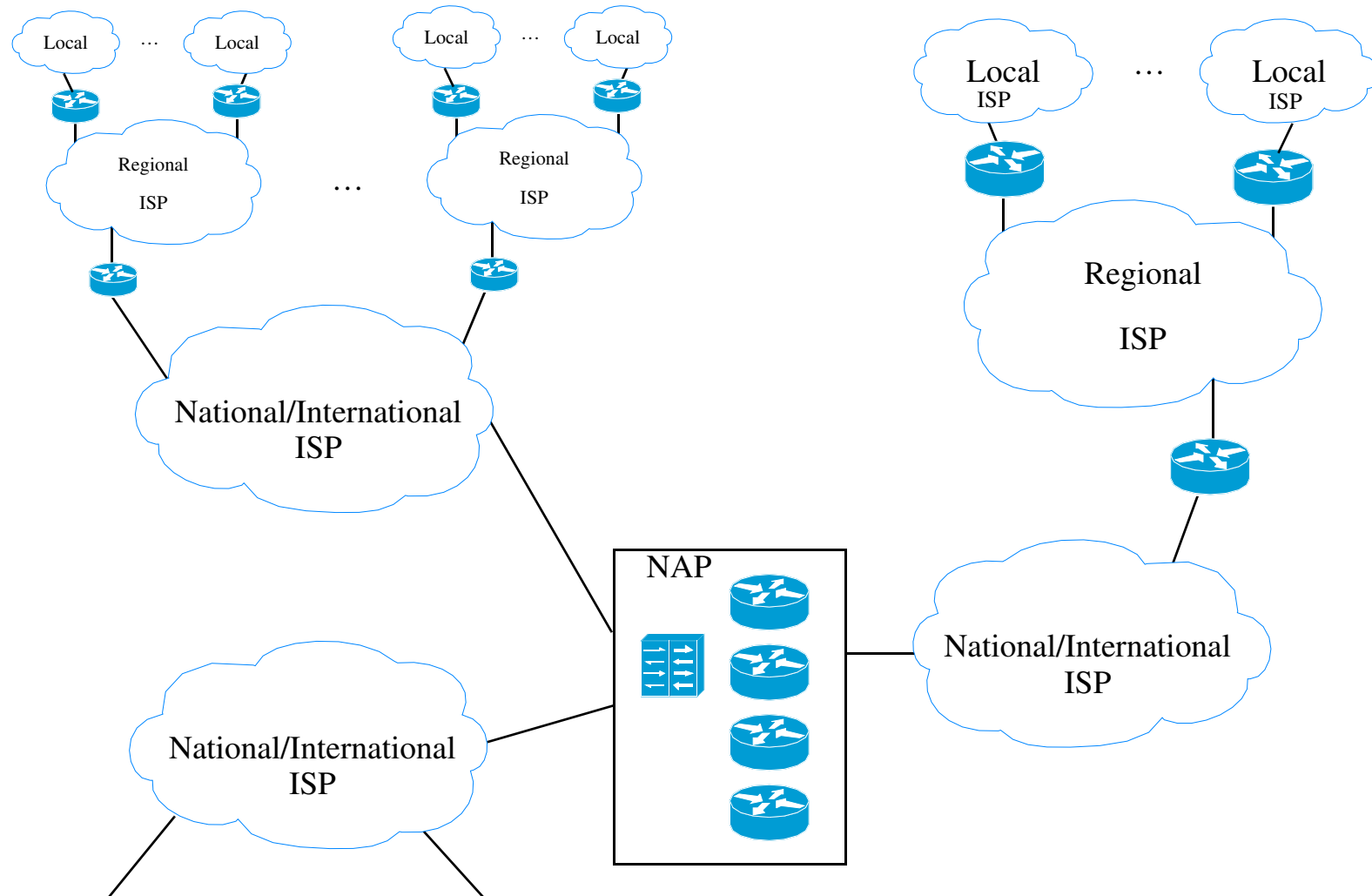

key: Internet Service Provider (ISP), Network Access Point (NAP)

# Clean slate re-design of the Internet

Many have questioned one or more of the basic concepts (open-architecture networking, End2End Argument, and Hourglass Model) and currently several groups are attempting to do a clean slate re-design of the Internet.

Consider for example the two research questions that researchers at Stanford University are asking as part of their Clean Slate program:

- "With what we know today, if we were to start again with a clean slate, how would we design a global communications infrastructure?", and
- "How should the Internet look in 15 years?"

-- Quoted from <http://cleanslate.stanford.edu/>

See also: [http://cleanslate.stanford.edu/about\\_cleanslate.php](http://cleanslate.stanford.edu/about_cleanslate.php)

This is only one of many such projects, see also:

- U. S. National Science Foundation GENI: <http://geni.net>
- European Union Future Internet Research and Experimentation (FIRE): <http://cordis.europa.eu/fp7/ict/fire/>



# Implicit vs. Explicit Information

Van Jacobson expresses this as:

- "The nice properties of packet switching result from moving source & destination information *implicit* in a circuit switch's time slot assignments into *explicit* addresses in the packet header. (But its easy to do this wrong, e.g., ATM.)
- The nice properties of dissemination result from making the time & sequence information *implicit* in a conversation be *explicit* in a fully qualified name."

-- slide 26: "Digression on Implicit vs. Explicit Information" of

Van Jacobson, "If a Clean Slate is the solution what was the problem?",  
Stanford Clean Slate Seminar, February 27, 2006

<http://cleanslate.stanford.edu/seminars/jacobson.pdf>

The emphasis (in *italic red characters*) in the above quotation were added by Maguire.

# Review of Layering

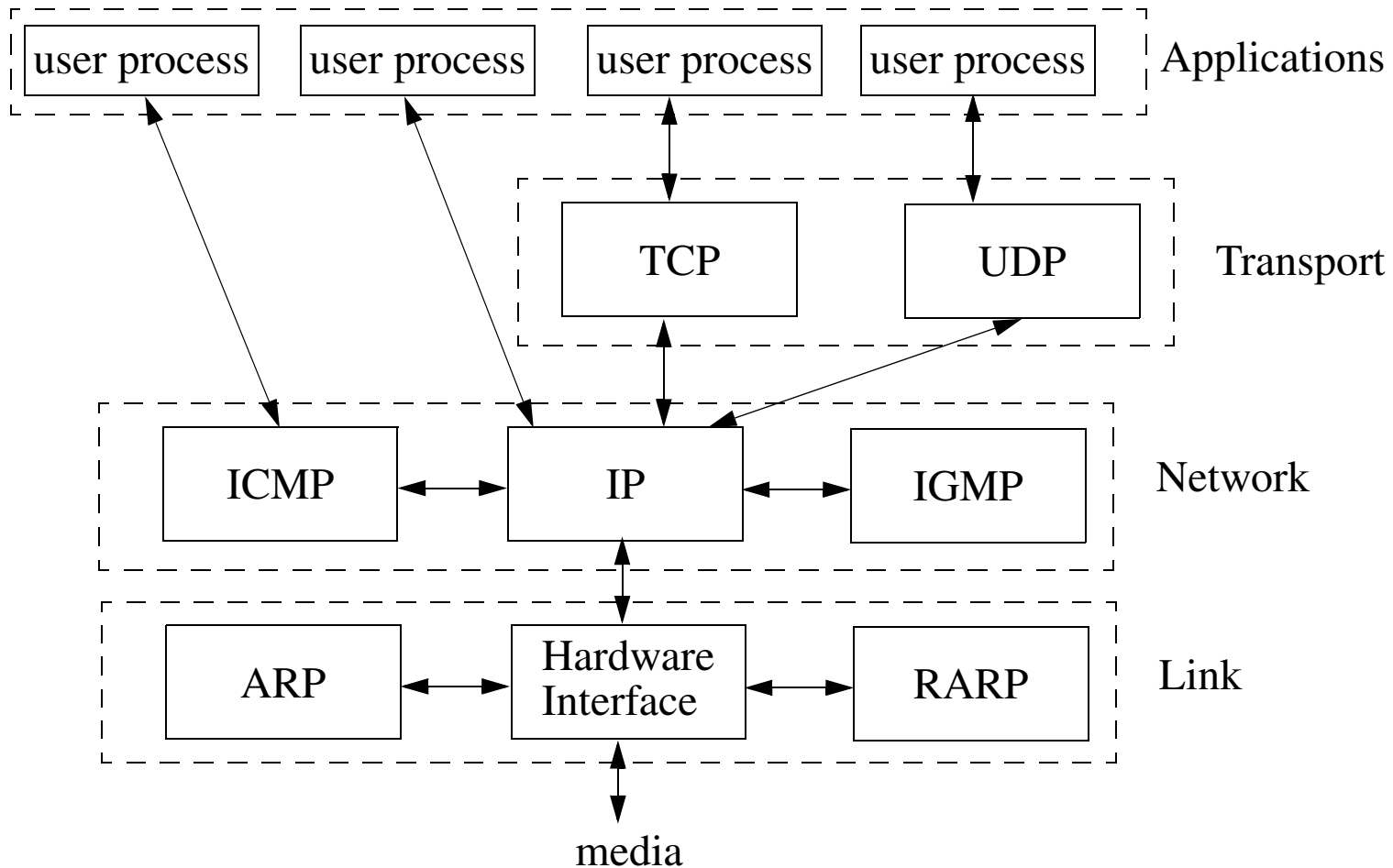

Figure 3: protocol layers in the TCP/IP protocol suite  
(see Stevens, Volume 1, figure 1.4, pg. 6)

# Encapsulation

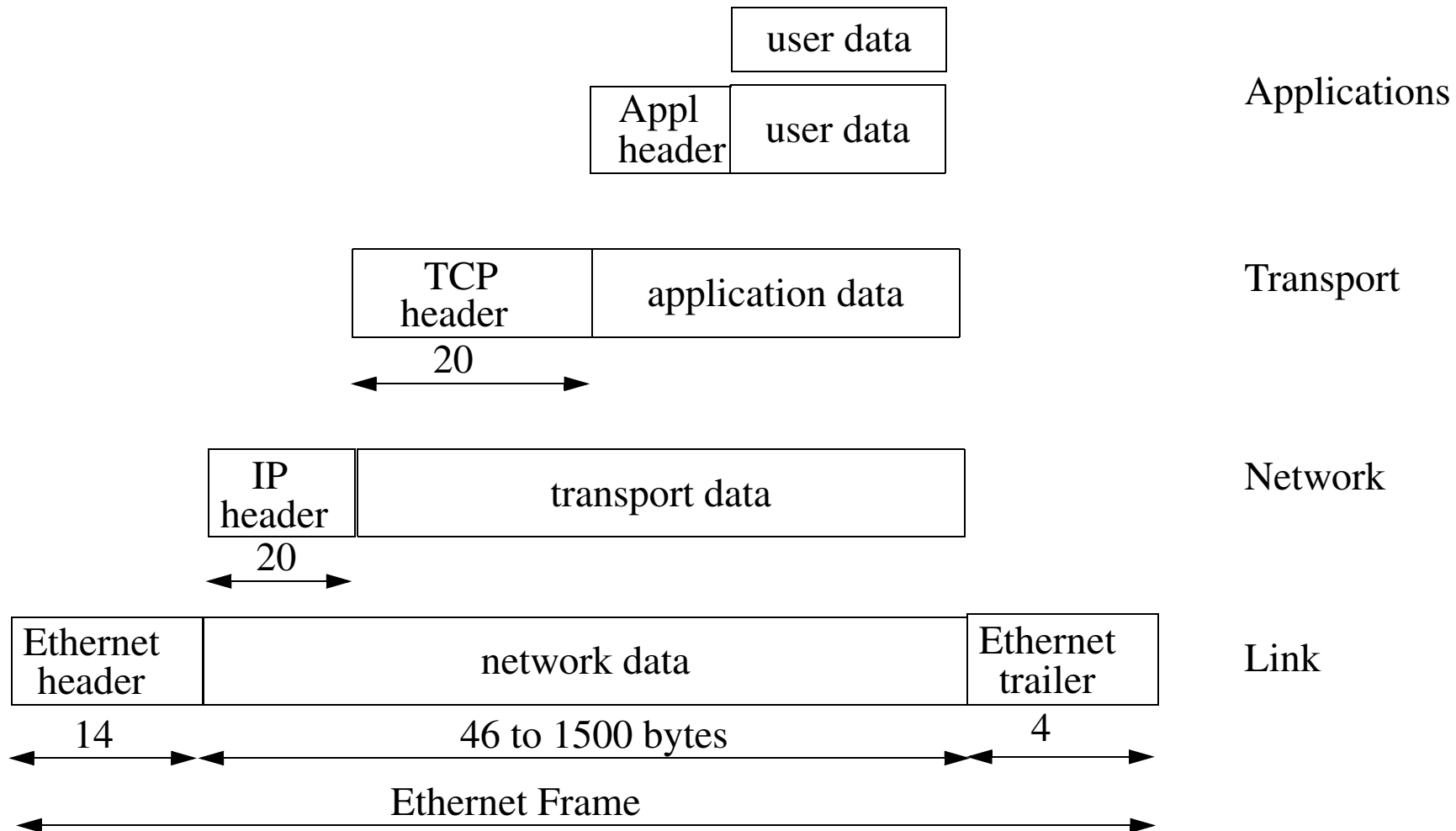

Figure 4: Encapsulation of data  
(see Stevens, Volume 1, figure 1.7, pg. 10)

# Demultiplexing

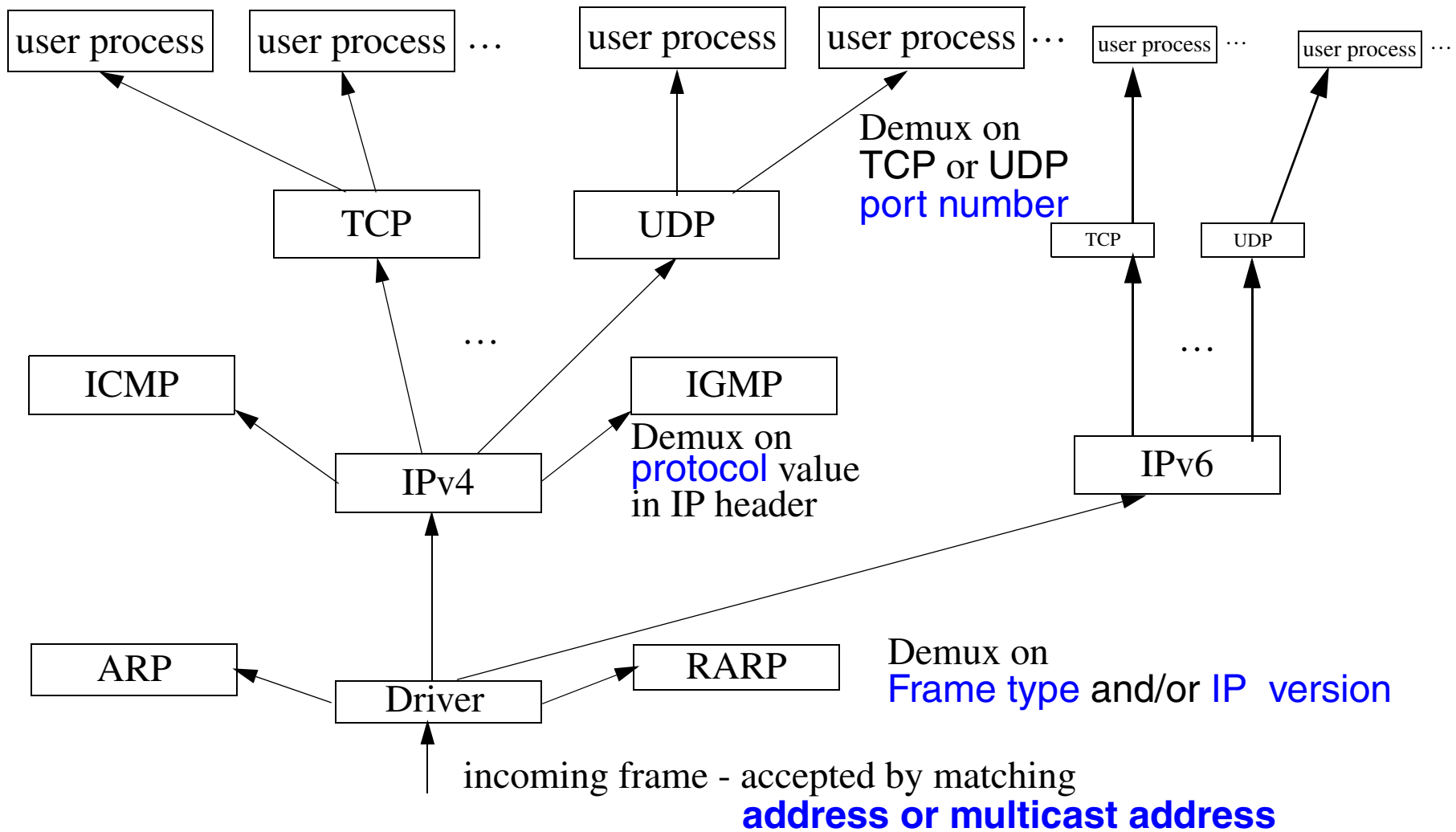

Figure 5: Demultiplexing

(adapted from Stevens, Volume 1, figure 1.8, pg. 11; with dual IP stacks)

# Addresses in TCP/IP

- Transport layer
  - Port number
- Network layer
  - IP address
  - Protocol
- Link & Physical layers
  - Frame type
  - Media Access and Control (MAC) address

# Internet Protocol version 4 (IPv4) (RFC 791)

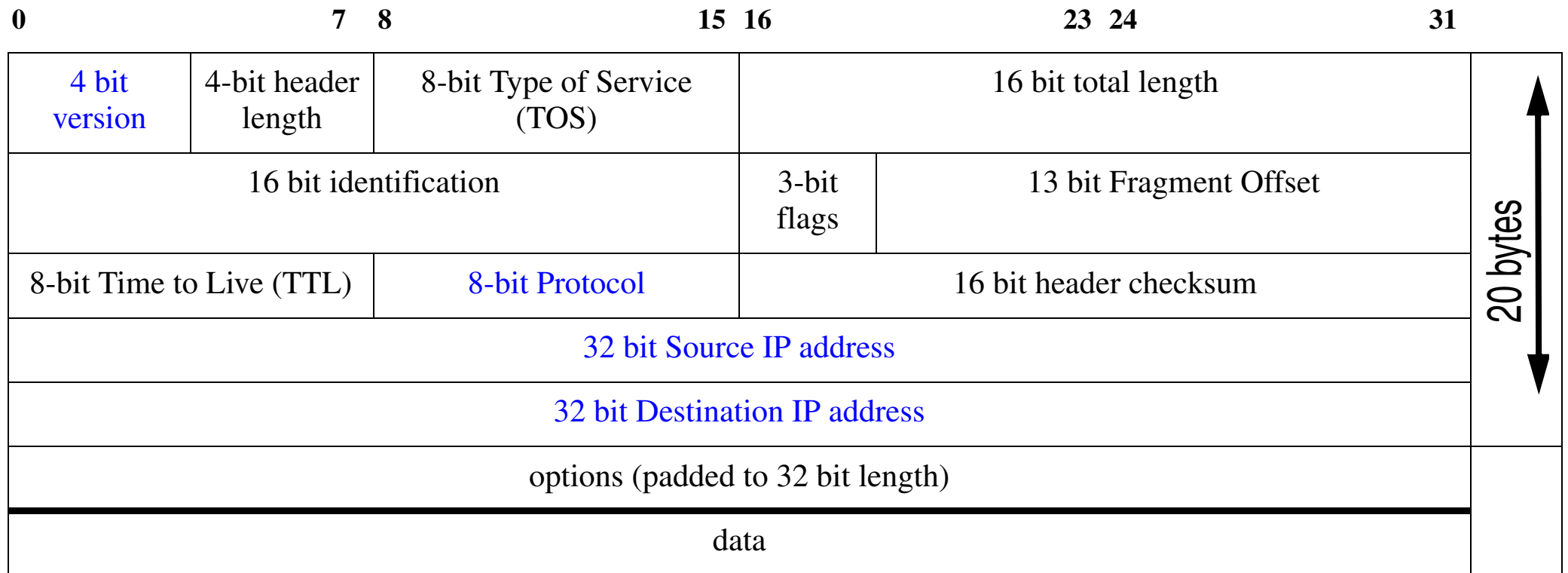

Figure 6: IP header (see Stevens, Vol. 1, figure 3.1, pg. 34)

The fields: Version, Protocol, and Source & Destination IP addresses are all used for **demultiplexing** the incoming IP packet.

We will first examine version 4, then later in the course version 6.

# IP “Protocol” field (RFC 1700)

In the Internet Protocol (IP), RFC 791 [22], there is a field, called **Protocol**, to identify the next level protocol. This is an 8 bit field.

Assigned Internet Protocol Numbers (assigned by *Internet Assigned Numbers Authority* (IANA) <http://www.iana.org/assignments/protocol-numbers> (last updated 2010-02-17))

| Decimal | Keyword     | Protocol   | References        |
|---------|-------------|--|-------------------|
| 0       | HOPOPT      | IPv6 Hop-by-Hop Option                                       | [RFC1883]         |
| 1       | ICMP        | Internet Control Message                                     | [RFC792]          |
| 2       | IGMP        | Internet Group Management                                    | [RFC1112]         |
| 3       | GGP         | Gateway-to-Gateway   | [RFC823]          |
| 4       | IP          | IP in IP (encapsulation)                                     | [RFC2003]         |
| 5       | ST          | Stream   | [RFC1190,RFC1819] |
| 6       | TCP         | Transmission Control   | [RFC793]          |
| 7       | CBT         | CBT  | [Ballardie]       |
| 8       | EGP         | Exterior Gateway Protocol                                    | [RFC888,DLM1]     |
| 9       | IGP         | any private interior<br>(e.g., used by Cisco for their IGRP) | [IANA]            |
| 10      | BBN-RCC-MON | BBN RCC Monitoring   | [SGC]             |
| 11      | NVP-II      | Network Voice Protocol                                       | [RFC741,SC3]      |
| 12      | PUP         | PUP  | [PUP,XEROX]       |

| Decimal | Keyword   | Protocol                             | References       |
|---------|-----------|--------------------------------------|------------------|
| 13      | ARGUS     | ARGUS                                | [RWS4]           |
| 14      | EMCON     | EMCON                                | [BN7]            |
| 15      | XNET      | Cross Net Debugger                   | [IEN158,JFH2]    |
| 16      | CHAOS     | Chaos                                | [NC3]            |
| 17      | UDP       | User Datagram                        | [RFC768,JBP]     |
| 18      | MUX       | Multiplexing                         | [IEN90,JBP]      |
| 19      | DCN-MEAS  | DCN Measurement Subsystems           | [DLM1]           |
| 20      | HMP       | Host Monitoring                      | [RFC869,RH6]     |
| 21      | PRM       | Packet Radio Measurement             | [ZSU]            |
| 22      | XNS-IDP   | XEROX NS IDP                         | [ETHERNET,XEROX] |
| 23      | TRUNK-1   | Trunk-1                              | [BWB6]           |
| 24      | TRUNK-2   | Trunk-2                              | [BWB6]           |
| 25      | LEAF-1    | Leaf-1                               | [BWB6]           |
| 26      | LEAF-2    | Leaf-2                               | [BWB6]           |
| 27      | RDP       | Reliable Data Protocol               | [RFC908,RH6]     |
| 28      | IRTP      | Internet Reliable Transaction        | [RFC938,TXM]     |
| 29      | ISO-TP4   | ISO Transport Protocol Class 4       | [RFC905,RC77]    |
| 30      | NETBLT    | Bulk Data Transfer Protocol          | [RFC969,DDC1]    |
| 31      | MFE-NSP   | MFE Network Services Protocol        | [MFENET,BCH2]    |
| 32      | MERIT-INP | MERIT Internodal Protocol            | [HWB]            |
| 33      | SEP       | Sequential Exchange Protocol         | [JC120]          |
| 34      | 3PC       | Third Party Connect Protocol         | [SAF3]           |
| 35      | IDPR      | Inter-Domain Policy Routing Protocol | [MXS1]           |



| Decimal | Keyword    | Protocol  | References      |
|---------|------------|---|-----------------|
| 36      | XTP        | XTP   | [GXC]           |
| 37      | DDP        | Datagram Delivery Protocol  | [WXC]           |
| 38      | IDPR-CMTP  | IDPR Control Message Transport Proto                                  | [MXS1]          |
| 39      | TP++       | TP++ Transport Protocol   | [DXF]           |
| 40      | IL         | IL Transport Protocol   | [Presotto]      |
| 41      | IPv6       | Ipv6  | [Deering]       |
| 42      | SDRP       | Source Demand Routing Protocol  | [DXE1]          |
| 43      | IPv6-Route | Routing Header for IPv6   | [Deering]       |
| 44      | IPv6-Frag  | Fragment Header for IPv6  | [Deering]       |
| 45      | IDRP       | Inter-Domain Routing Protocol   | [Sue Hares]     |
| 46      | RSVP       | Reservation Protocol  | [Bob Braden]    |
| 47      | GRE        | General Routing Encapsulation   | [Tony Li]       |
| 48      | MHRP       | Mobile Host Routing Protoco   | [David Johnson] |
| 49      | BNA        | BNA   | [Gary Salamon]  |
| 50      | ESP        | Encap Security Payload for IPv6                                       | [RFC1827]       |
| 51      | AH         | Authentication Header for IPv6  | [RFC1826]       |
| 52      | I-NLSP     | Integrated Net Layer Security TUBA                                    | [GLENN]         |
| 53      | SWIPE      | IP with Encryption  | [JI6]           |
| 54      | NARP       | NBMA Address Resolution Protocol                                      | [RFC1735]       |
| 55      | MOBILE     | IP Mobility   | [Perkins]       |
| 56      | TLSP       | Transport Layer Security Protocol (using<br>Kryptonet key management) | [Oberg]         |
| 57      | SKIP       | SKIP  | [Markson]       |

| Decimal | Keyword    | Protocol                            | References  |
|---------|------------|-------------------------------------|-------------|
| 58      | IPv6-ICMP  | ICMP for IPv6                       | [RFC1883]   |
| 59      | IPv6-NoNxt | No Next Header for IPv6             | [RFC1883]   |
| 60      | IPv6-Opts  | Destination Options for IPv6        | [RFC1883]   |
| 61      |            | any host internal protocol          | [IANA]      |
| 62      | CFTP       | CFTP                                | [CFTP,HCF2] |
| 63      |            | any local network                   | [IANA]      |
| 64      | SAT-EXPAK  | SATNET and Backroom EXPAK           | [SHB]       |
| 65      | KRYPTOLAN  | Kryptolan                           | [PXL1]      |
| 66      | RVD        | MIT Remote Virtual Disk Protocol    | [MBG]       |
| 67      | IPPC       | Internet Pluribus Packet Core       | [SHB]       |
| 68      |            | any distributed file system         | [IANA]      |
| 69      | SAT-MON    | SATNET Monitoring                   | [SHB]       |
| 70      | VISA       | VISA Protocol                       | [GXT1]      |
| 71      | IPCV       | Internet Packet Core Utility        | [SHB]       |
| 72      | CPNX       | Computer Protocol Network Executive | [DXM2]      |
| 73      | CPHB       | Computer Protocol Heart Beat        | [DXM2]      |
| 74      | WSN        | Wang Span Network                   | [VXD]       |
| 75      | PVP        | Packet Video Protocol               | [SC3]       |
| 76      | BR-SAT-MON | Backroom SATNET Monitoring          | [SHB]       |
| 77      | SUN-ND     | SUN ND PROTOCOL-Temporary           | [WM3]       |
| 78      | WB-MON     | WIDEBAND Monitoring                 | [SHB]       |
| 79      | WB-EXPAK   | WIDEBAND EXPAK                      | [SHB]       |
| 80      | ISO-IP     | ISO Internet Protocol               | [MTR]       |

| Decimal | Keyword     | Protocol                                | References     |
|---------|-------------|---|----------------|
| 81      | VMTP        | VMTP                                    | [DRC3]         |
| 82      | SECURE-VMTP | SECURE-VMTP                             | [DRC3]         |
| 83      | VINES       | VINES                                   | [BXH]          |
| 84      | TTP         | TTP                                     | [JXS]          |
| 85      | NSFNET-IGP  | NSFNET-IGP                              | [HWB]          |
| 86      | DGP         | Dissimilar Gateway Protocol             | [DGP,ML109]    |
| 87      | TCF         | TCF                                     | [GAL5]         |
| 88      | EIGRP       | EIGRP                                   | [CISCO,GXS]    |
| 89      | OSPFIGP     | OSPFIGP                                 | [RFC1583,JTM4] |
| 90      | Sprite-RPC  | Sprite RPC Protocol                     | [SPRITE,BXW]   |
| 91      | LARP        | Locus Address Resolution Protocol       | [BXH]          |
| 92      | MTP         | Multicast Transport Protocol            | [SXA]          |
| 93      | AX.25       | AX.25 Frames                            | [BK29]         |
| 94      | IPIP        | IP-within-IP Encapsulation Protocol     | [JI6]          |
| 95      | MICP        | Mobile Internetworking Control Protocol | [JI6]          |
| 96      | SCC-SP      | Semaphore Communications Sec. Pro.      | [HXH]          |
| 97      | ETHERIP     | Ethernet-within-IP Encapsulation        | [RXH1]         |
| 98      | ENCAP       | Encapsulation Header                    | [RFC1241,RXB3] |
| 99      |             | any private encryption scheme           | [IANA]         |
| 100     | GMTP        | GMTP                                    | [RXB5]         |
| 101     | IFMP        | Ipsilon Flow Management Protocol        | [Hinden]       |
| 102     | PNNI        | PNNI over IP                            | [Callon]       |
| 103     | PIM         | Protocol Independent Multicast          | [Farinacci]    |

| Decimal | Keyword     | Protocol                            | References   |
|---------|-------------|-------------------------------------|--------------|
| 104     | ARIS        | ARIS                                | [Feldman]    |
| 105     | SCPS        | SCPS                                | [Durst]      |
| 106     | QNX         | QNX                                 | [Hunter]     |
| 107     | A/N         | Active Networks                     | [Braden]     |
| 108     | IPComp      | IP Payload Compression Protocol     | [RFC2393]    |
| 109     | SNP         | Sitara Networks Protocol            | [Sridhar]    |
| 110     | Compaq-Peer | Compaq Peer Protocol                | [Volpe]      |
| 111     | IPX-in-IP   | IPX in IP                           | [Lee]        |
| 112     | VRRP        | Virtual Router Redundancy Protocol  | [Hinden]     |
| 113     | PGM         | PGM Reliable Transport Protocol     | [Speakman]   |
| 114     |             | any 0-hop protocol                  | [IANA]       |
| 115     | L2TP        | Layer Two Tunneling Protocol        | [Aboba]      |
| 116     | DDX         | D-II Data Exchange (DDX)            | [Worley]     |
| 117     | IATP        | Interactive Agent Transfer Protocol | [Murphy]     |
| 118     | STP         | Schedule Transfer Protocol          | [JMP]        |
| 119     | SRP         | SpectraLink Radio Protocol          | [Hamilton]   |
| 120     | UTI         | UTI                                 | [Lothberg]   |
| 121     | SMP         | Simple Message Protocol             | [Ekblad]     |
| 122     | SM          | SM                                  | [Crowcroft]  |
| 123     | PTP         | Performance Transparency Protocol   | [Welzl]      |
| 124     | ISIS        | over IPv4                           | [Przygienda] |
| 125     | FIRE        |                                     | [Partridge]  |
| 126     | CRTP        | Combat Radio Transport Protocol     | [Sautter]    |

| Decimal | Keyword                             | Protocol                               | References   |
|---------|-------------------------------------|--|--|
| 127     | CRUDP                               | Combat Radio User Datagram             | [Sautter]  |
| 128     | SSCOPMCE                            |  | [Waber]  |
| 129     | IPLT                                |  | [Hollbach]   |
| 130     | SPS                                 | Secure Packet Shield                   | [McIntosh]   |
| 131     | PIPE                                | Private IP Encapsulation within IP     | [Petri]  |
| 132     | SCTP                                | Stream Control Transmission Protocol   | [Stewart]  |
| 133     | FC                                  | Fibre Channel                          | [Rajagopal]  |
| 134     | FRSVP-E2E-IGNORE                    |  | [RFC3175]  |
| 136     | UDPLite                             |  | [RFC3828]  |
| 137     | MPLS-in-IP                          |  | [RFC-ietf-mpls-in-ip-or-g<br>re-08.txt]              |
| 138     | manet                               | MANET Protocols                        | [RFC-ietf-manet-iana-07.t<br>xt]                     |
| 139     | HIP                                 | Host Identity Protocol                 | [RFC-ietf-hip-base-10.txt]                           |
| 140     | Shim6                               | Shim6 Protocol                         | [RFC5533]  |
| 141     | WESP                                | Wrapped Encapsulating Security Payload | [RFC-ietf-ipsecme-traffic-<br>visibility-12.txt]     |
| 142     | ROHC                                | Robust Header Compression              | [RFC-ietf-rohc-ipsec-exte<br>nsions-hcoipsec-08.txt] |
| 143-252 | Unassigned                          |  | [IANA]   |
| 253     | Use for experimentation and testing |  | [RFC3692]  |
| 254     | Use for experimentation and testing |  | [RFC3692]  |
| 255     | Reserved                            |  | [IANA]   |

As of Feb. 2010, there were ~46 fewer available protocol numbers than at the time of the course in 1999.

# Basic communication mechanism: datagram

Properties of datagrams:

- Best effort
- Each message handled independently — global addressing.
- IP packets (datagrams) are forwarded according to the network address (which is in each datagram) by **routers**.

# Basic Ethernet + IP Software Architecture

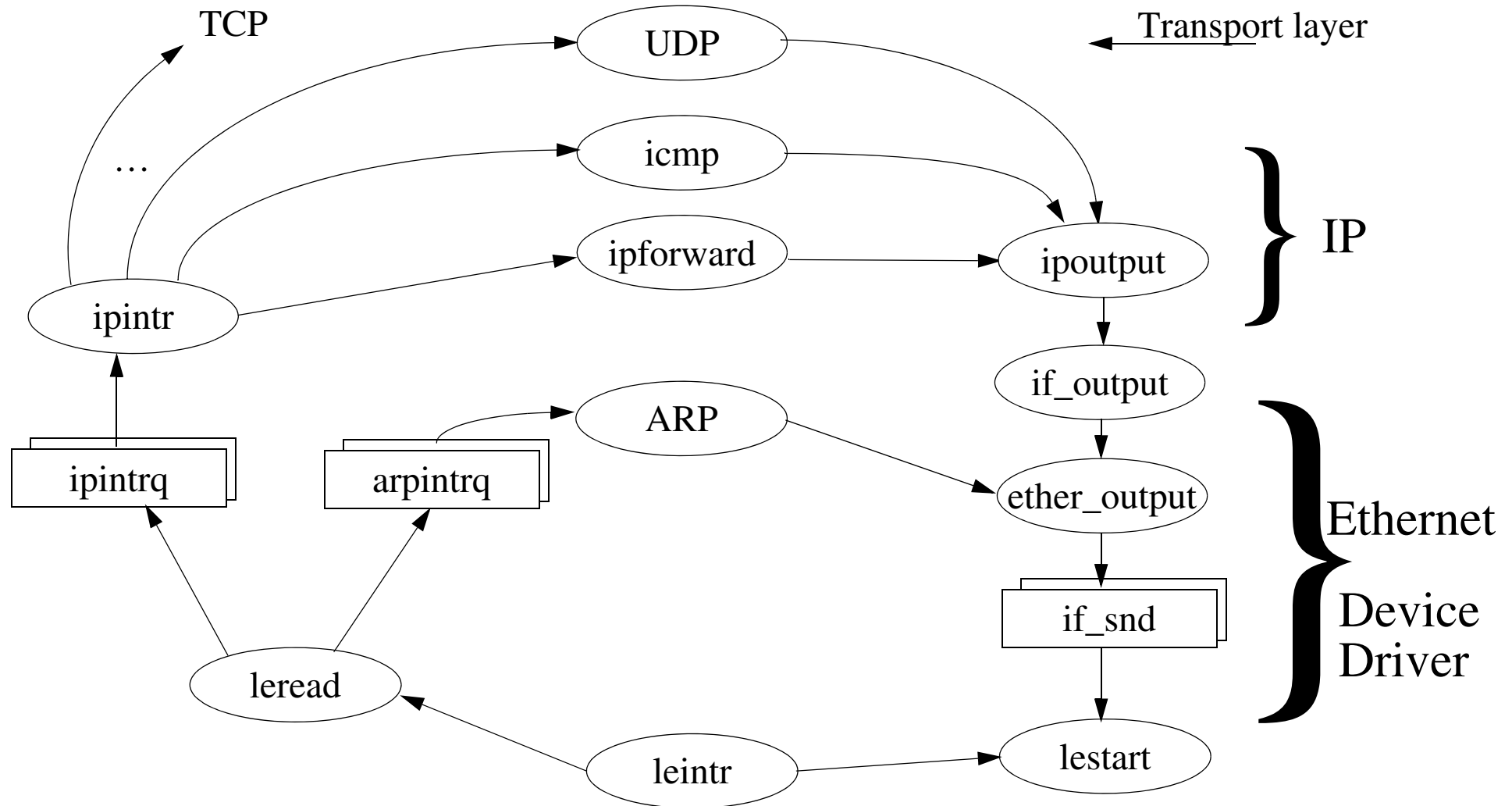

Figure 7: Basic Ethernet + IP Architecture - based on Stevens, TCP/IP Illustrated, Volume 2



# Common Used Simple Services

| Name     | TCP port | UDP port | RFC | Description   |
|----------|----------|----------|-----|---|
| echo     | 7        | 7        | 862 | server returns what the client sends  |
| discard  | 9        | 9        | 863 | server discards what the client sends   |
| daytime  | 13       | 13       | 867 | Server returns the time and date in a human readable format   |
| chargen  | 19       | 19       | 864 | TCP server sends a continual stream of character, until the connection is terminated by the client. UDP server sends a datagram containing a random number of characters each time the client sends a datagram. |
| ftp-data | 20       |          |     | File Transfer Protocol (Data)   |
| ftp      | 21       |          |     | File Transfer Protocol (Control)  |
| telnet   | 23       |          |     | Virtual Terminal Protocol   |
| smtp     | 25       |          |     | Simple Mail Transfer Protocol   |
| time     | 37       | 37       | 868 | Server returns the time as a 32-bit binary number. This number is the time in seconds since 1 Jan. 1990, UTC  |

# Link Layer

Possible link layers include:

- Ethernet and IEEE 802.3 Encapsulation
  - with possible Trailer Encapsulation
- SLIP: Serial Line IP
- CSLIP: Compress SLIP
- PPP: Point to Point Protocol
- Loopback Interface
- Virtual Interface
- ...
- carrier pigeons - CPIP (Carrier Pigeon Internet Protocol) April 1st 1990, RFC 1149 was written. A protocol for IP over avian carriers. Implementation (April 28 2001): <http://www.blog.linux.no/rfc1149/>

Some of the issues concerning links are:

- MTU and Path MTU
- Serial line throughput

# Simple Campus Network

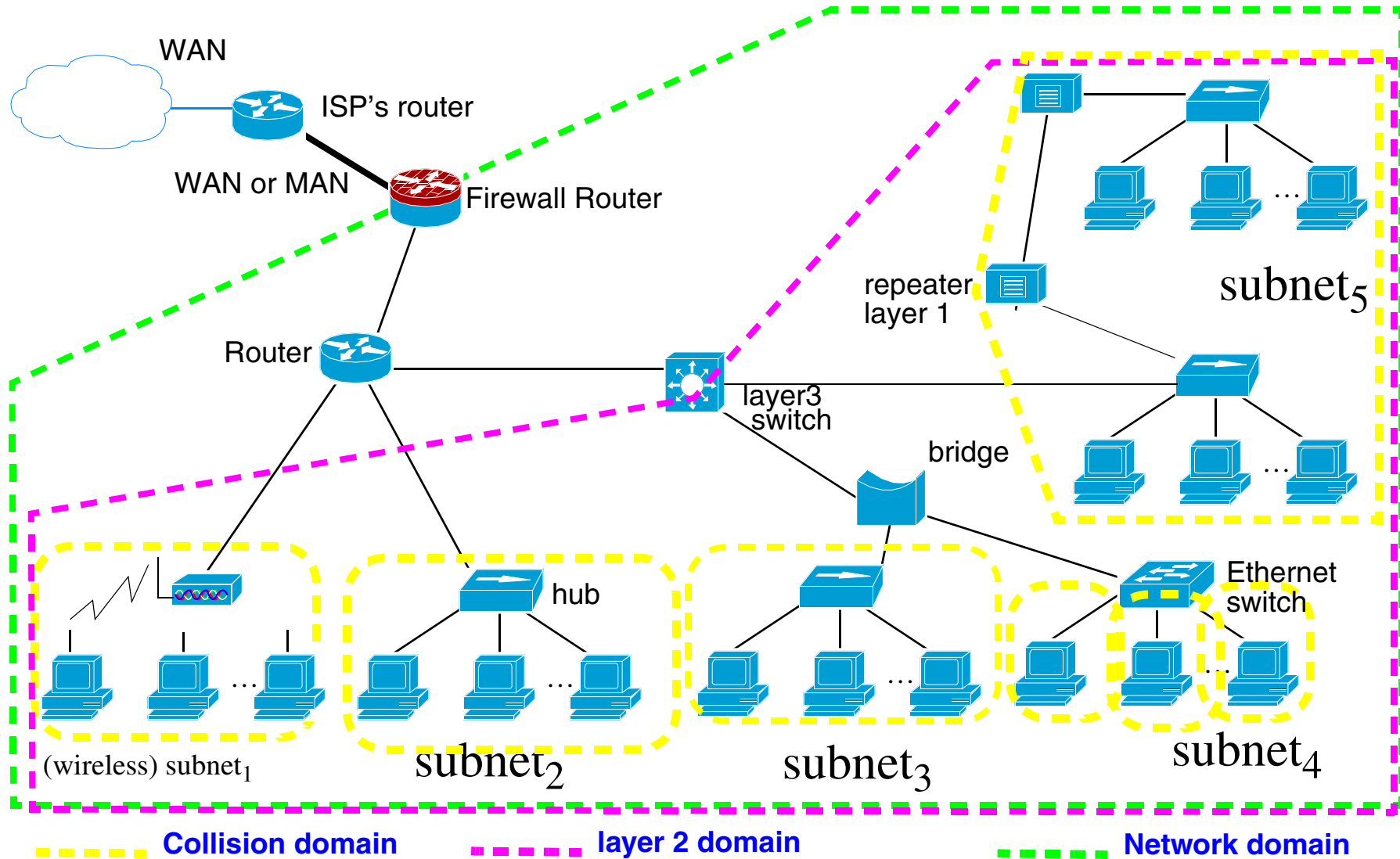

# Connecting Devices

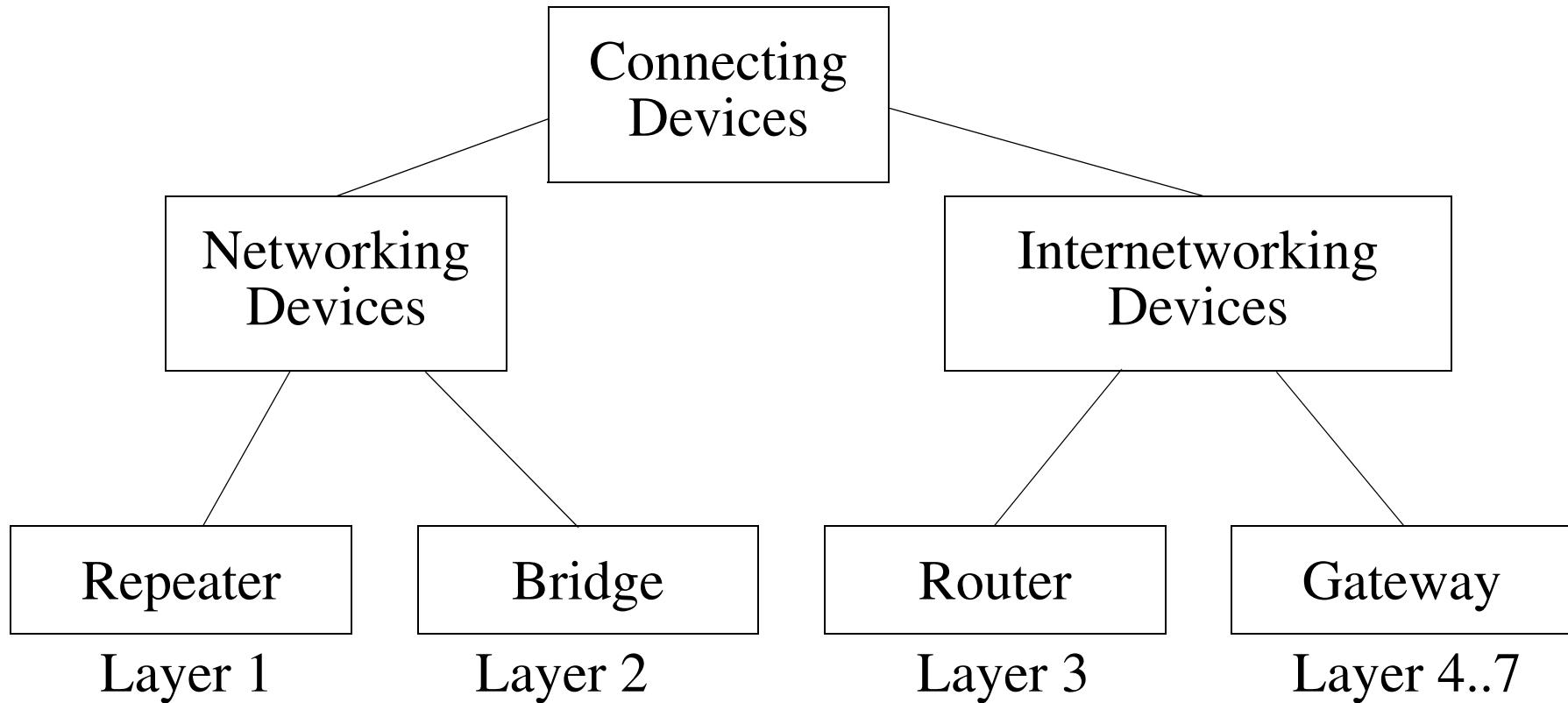

- Ethernet hub = a multiport repeater
- Ethernet switch = a multiport bridge
- Layer 3 switch = combines functions of an ethernet switch and a router

# How important are switches vs. routers?

There are an enormous number of switches sold per year. Probably more than one switch port sold per wired Ethernet interface!

| Cisco                              | July 28,2007        | Percentage of net product sales |
|------------------------------------|---------------------|---------------------------------|
| Routers                            | US\$ 6,920 M        | 23.5%                           |
| Switches                           | US\$12,473 M        | 42.3%                           |
| Advanced Technologies <sup>a</sup> | US\$ 8,075 M        | 27.4%                           |
| Other <sup>b</sup>                 | US\$ 1,994 M        | 6.1%                            |
| <b>Total</b>                       | <b>US\$29,462 M</b> |                                 |

a. Video Systems, Unified Communications, Home networking, Security products, WLAN, and Storage Area networking

b. Optical networking, sales of IP-based solutions to other service providers, and Scientific-Atlanta

For comparison purposes: HP's Corporate Investments (which includes their Ethernet switch business) was US\$566 M in 2006 - and had grown 8% over the previous year due to gigabit switch products[10]; while in 2007 it was US\$762 M with a 33% growth attributed to enterprise class gigabit network switches! [11]

# LAN Protocols

|                 |               |
|-----------------|---------------|
| Data link Layer | LLC Sublayer  |
|                 | MAC Sublayers |
| Physical Layer  |               |

OSI Layers

|          |                       |                         |                          |                     |                     |                    |
|----------|-----------------------|-------------------------|--------------------------|---------------------|---------------------|--------------------|
| Ethernet | IEEE 802.2            |                         |                          |                     |                     |                    |
|          | IEEE 802.3            | IEEE 802.4<br>Token Bus | IEEE 802.5<br>Token Ring | IEEE 802.11<br>WLAN | IEEE 802.15<br>WPAN | IEEE 802.16<br>MAN |
|          | IEEE 802.20<br>(MBWA) |                         |                          |                     |                     |                    |

LAN specifications

Figure 8: Physical and Link layer protocols used for LANs

# Ethernet Encapsulation (RFC 894)

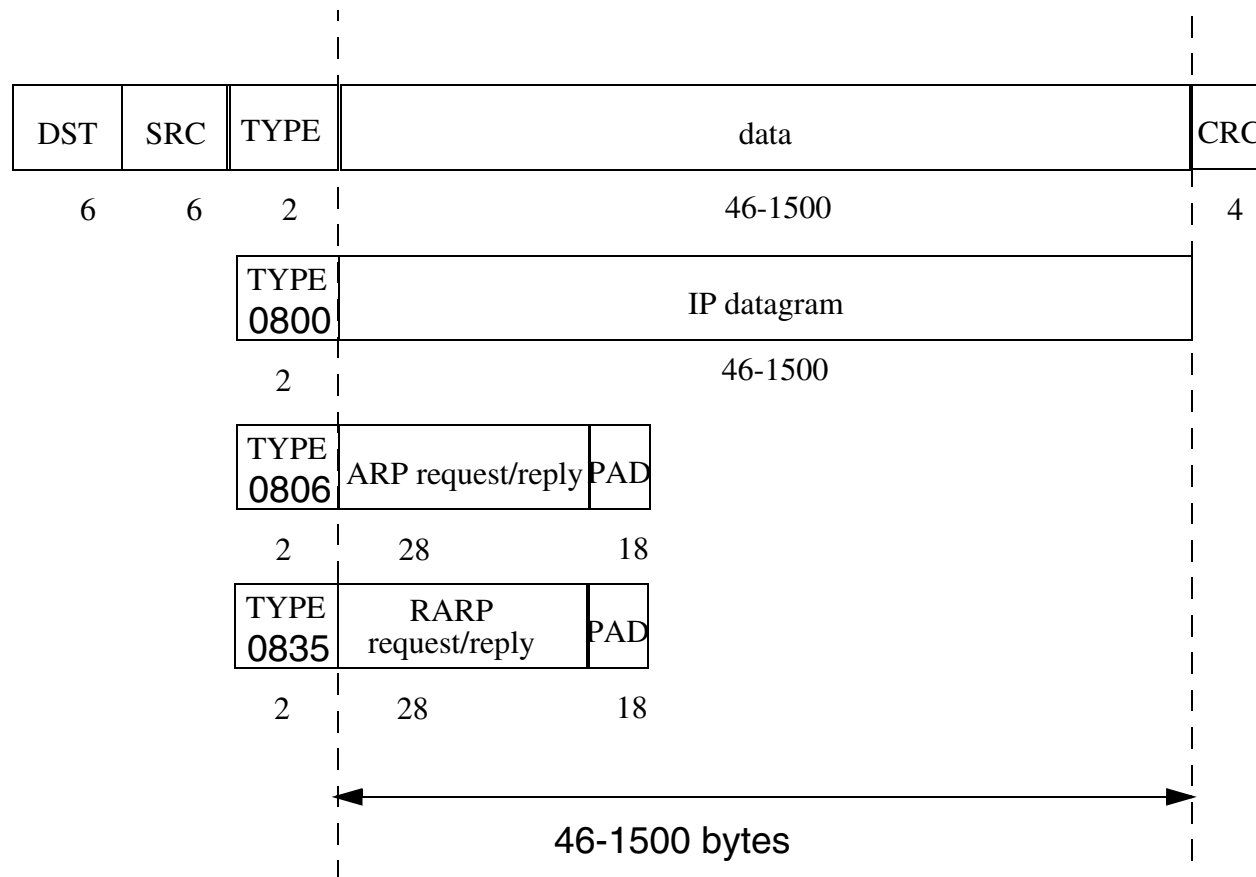

Figure 9: Ethernet encapsulation

(see Stevens, Volume 1, figure 2.1, pg. 23)

DST = Destination MAC Address, SRC = Source MAC Address (both are 48 bits in length);

TYPE = Frame Type; CRC = Cyclic Redundancy Check, i.e., checksum

# IEEE 802.2/802.3 Encapsulation (RFC 1042)

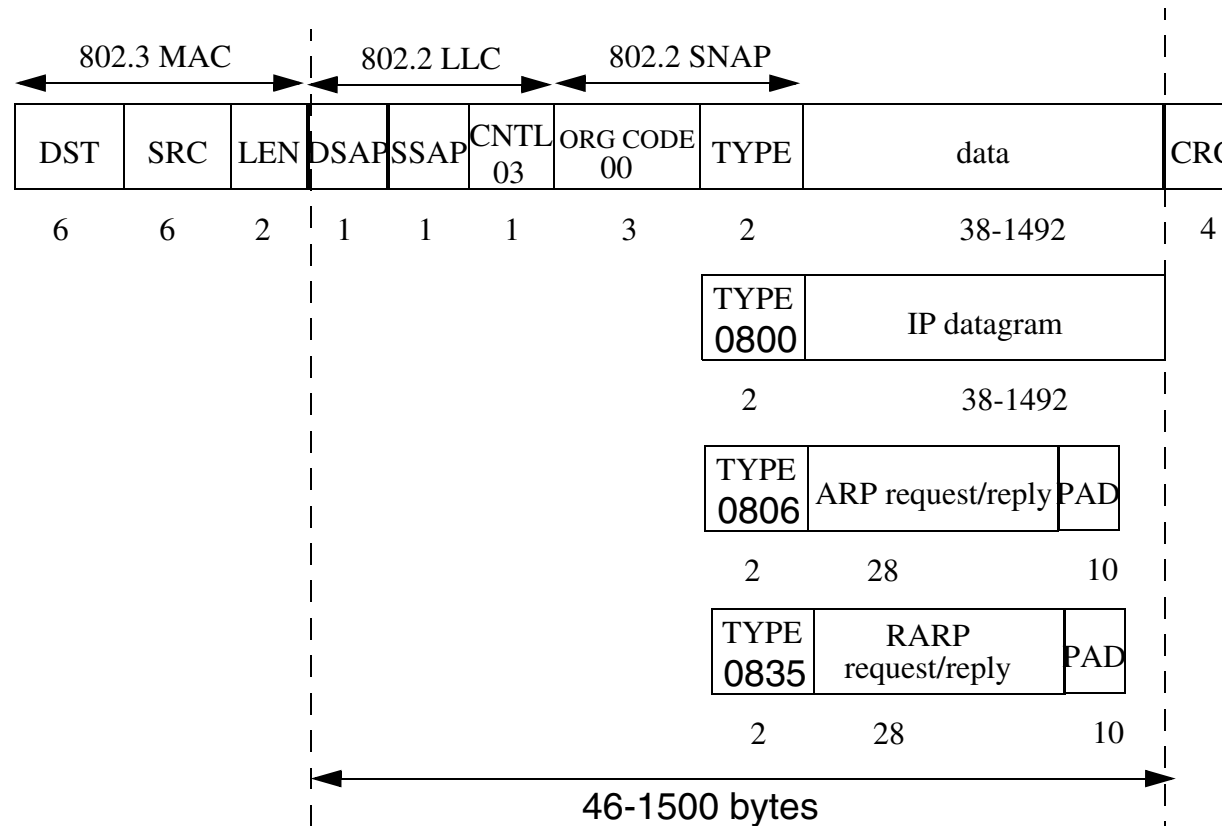

Figure 10: IEEE802.2/802.3 (see Stevens, Volume 1, figure 2.1, pg. 23)

DSAP  $\equiv$  Destination Service Access Point; SSAP  $\equiv$  Source Service Access Point; SNAP  $\equiv$  Sub-Network Access Protocol; for other TYPE values see RFC1700.



# IEEE 802 Numbers of Interest

“... IEEE 802 Networks. These systems may use a Link Service Access Point (LSAP) field in much the same way the MILNET uses the “link” field. Further, there is an extension of the LSAP header called the Sub-Network Access Protocol (SNAP).

The IEEE likes to describe numbers in binary in [bit transmission order](#), which is the opposite of the [big-endian order](#) used throughout the Internet protocol documentation.” - see <http://www.iana.org/assignments/ieee-802-numbers>

## Assignments from RFC1700

| Link Service Access Point |                 |         | Description                 | References                |
|---------------------------|-----------------|---------|-----------------------------|---------------------------|
| IEEE binary               | Internet binary | decimal |                             |                           |
| 00000000                  | 00000000        | 0       | Null LSAP                   | [IEEE]                    |
| 01000000                  | 00000010        | 2       | Individual LLC Sublayer Mgt | [IEEE]                    |
| 11000000                  | 00000011        | 3       | Group LLC Sublayer Mgt      | [IEEE]                    |
| 00100000                  | 00000100        | 4       | SNA Path Control            | [IEEE]                    |
| 01100000                  | 00000110        | 6       | Reserved (DOD IP)           | RFC 768 [14]              |
| 01110000                  | 00001110        | 14      | PROWAY-LAN                  | [IEEE]                    |
| 01110010                  | 01001110        | 78      | EIA-RS 511                  | [IEEE]                    |
| 01111010                  | 01011110        | 94      | ISI IP                      | [JBP]                     |
| 01110001                  | 10001110        | 142     | PROWAY-LAN                  | [IEEE]                    |
| 01010101                  | 10101010        | 170     | SNAP                        | [IEEE] (see RFC 1042[13]) |
| 01111111                  | 11111110        | 254     | ISO CLNS IS 8473            | RFC 926 [15]              |
| 11111111                  | 11111111        | 255     | Global DSAP                 | [IEEE]                    |

# SLIP (RFC 1055)

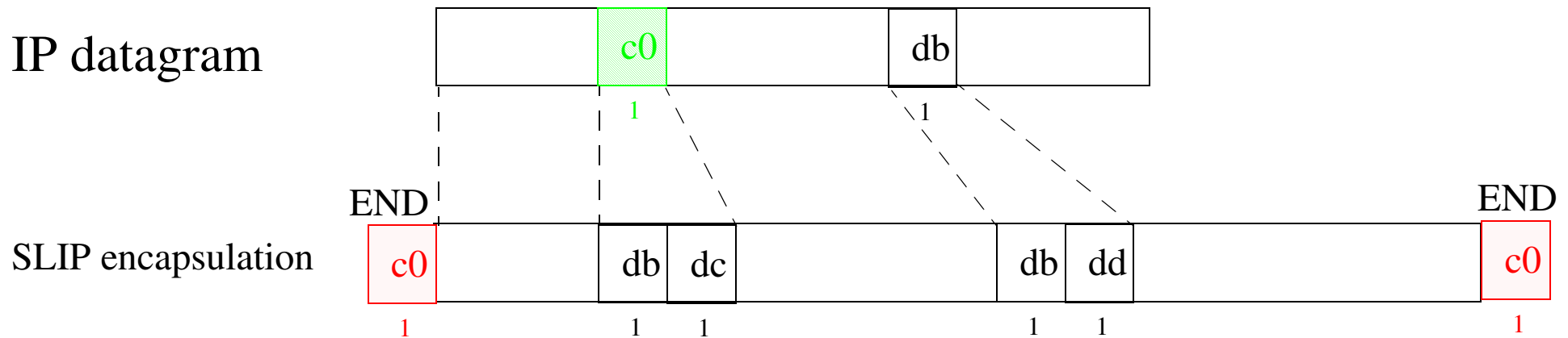

Figure 11: SLIP Encapsulation (see Stevens, Volume 1, figure 2.2, pg. 25)

RFC 1055: [Nonstandard](#) for transmission of IP datagrams over serial lines: SLIP [16]

SLIP uses character stuffing, SLIP ESC character  $\equiv$  0xdb

SLIP END character  $\equiv$  0xc0

- point to point link,  $\Rightarrow$  no IP addresses need to be sent
- there is no TYPE field,  $\Rightarrow$  you can only be sending IP, i.e., can't mix protocols
- there is no CHECKSUM,  $\Rightarrow$  error detection has to be done by higher layers

# SLIP Problems $\Rightarrow$ CSLIP $\equiv$ Compressed SLIP

- because many users running SLIP over lines at 19.2 kbits/s or slower
- lots of interactive traffic (telnet, rlogin, ...) which uses TCP
  - many small packets
  - each of which needs a TCP header (20 bytes) + IP header (20 bytes)  $\Rightarrow$  overhead 40 bytes
  - Send 1 user character requires sending a minimum of: 1 + 40 + END, i.e., 42 bytes
  - most of the header is **predictable**

CSLIP (RFC 1144: Compressing TCP/IP headers for low-speed serial links, by Van Jacobson)[17] reduces the header to 3-5 bytes, by:

- trying to keep response time under 100-200ms
- keeping state about  $\sim$ 16 TCP connections at each end of the link
  - the 96-bit tuple <src address, dst address, src port, dst port> reduced to 4 bits
- many header fields rarely change - so don't transmit them
- some header fields change by a small amount - just send the delta
- no compression is attempted for UDP/IP
- a 5 byte compressed header on 100-200 bytes  $\Rightarrow$  95-98% line efficiency

# Robust Header Compression (rohc)

Header compression schemes that perform well over links with high error rates and long roundtrip times.

<http://www.ietf.org/html.charters/rohc-charter.html>

# PPP: Point to Point Protocol

PPP (RFCs 1331[18]&1332[19]) corrects the deficiencies in SLIP and consists of:

- encapsulation for either async or synchronous links,
  - HDLC (see RFC 1549)
  - X.25 (see RFC 1598)
  - ISDN (see RFC 1618)
  - SONET/SDH (see RFC 1619)
- Link Control Protocol
  - establish, configure, and test data-links [includes option negotiation]
  - authentication (see RFC 1334)
- Family of Network Control Protocols (NCPs) - specific to different network protocols, currently:
  - IP (see RFC 1332)
  - DECnet (see RFC 1376)
  - OSI network layer (see RFC 1377)
  - AppleTalk (see RFC 1378)
  - XNS (see RFC 1764)

See: James D. Carlson, “PPP Design, Implementation, and Debugging”, Second edition, Addison-Wesley, 2000, ISBN 0-201-70053-0 [8].

# PPP frames

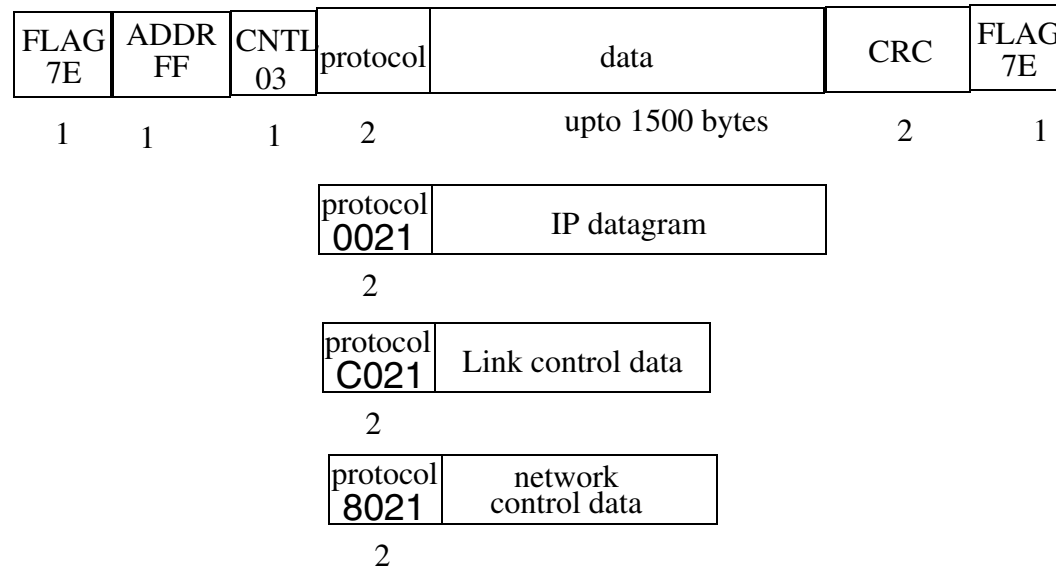

Figure 12: Format of PPP frame (see Stevens, Volume 1, figure 2.3, pg. 26)

- The protocol field behaves like the Ethernet TYPE field.
- CRC can be used to detect errors in the frame.
- Either character or bit stuffing is done depending on the link.
- you can negotiate away the CNTL and ADDRESS fields, and reduce the protocol field to 1 byte  $\Rightarrow$  minimum overhead of 3 bytes
- Van Jacobson header compression for IP and TCP

# PPP summary

- support for multiple protocols on a link
- CRC check on every frame
- dynamic negotiation of IP address of each end
- header compression (similar to CSLIP)
- link control with facilities for negotiating lots of data-link options

All at a price averaging 3 bytes of overhead per frame.

# Loopback interface

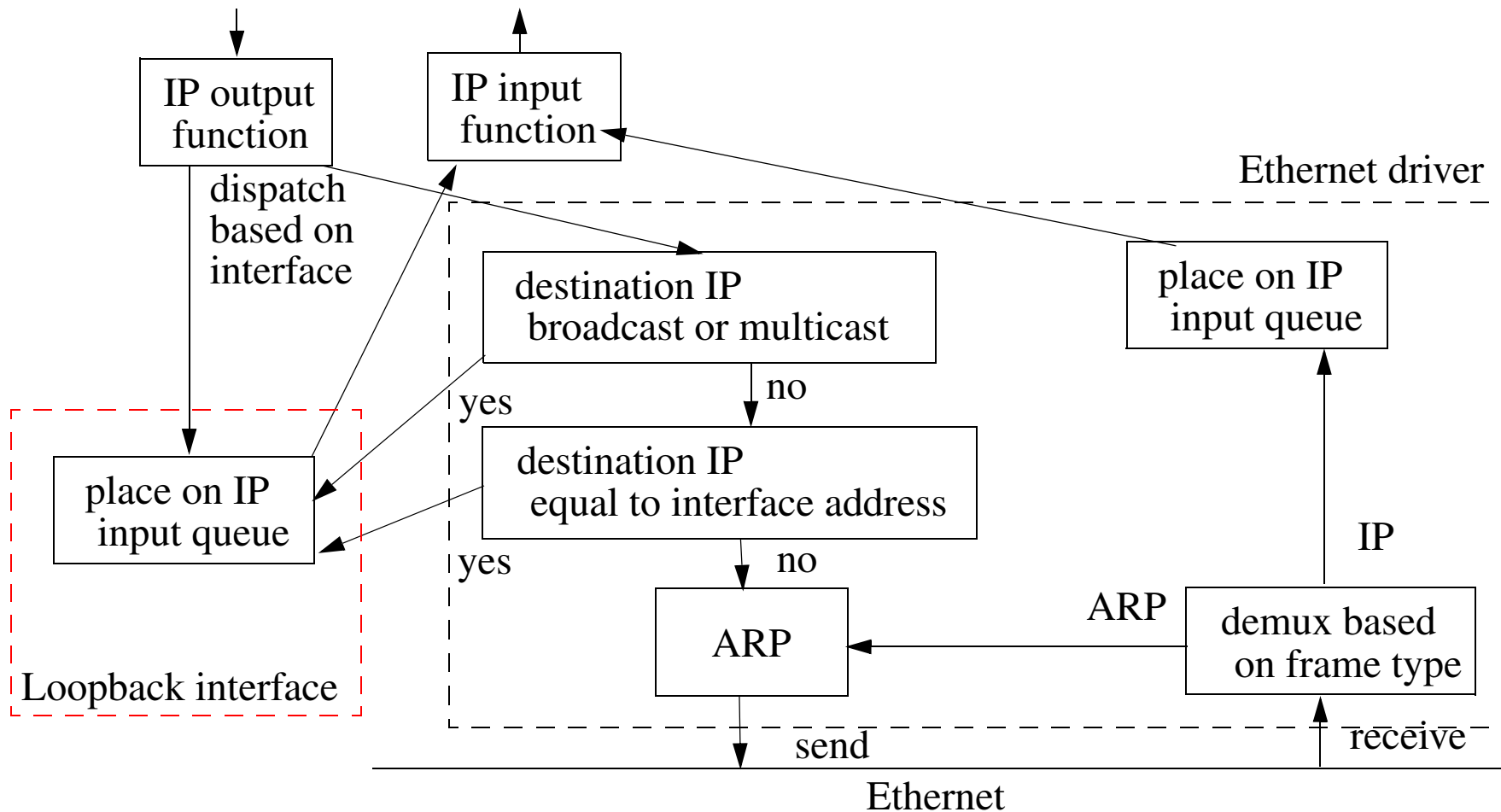

Figure 13: Processing of IP Datagrams (adapted from Stevens, Volume 1, figure 2.4, pg. 28)



# Loopback interface summary

- loopback address  $\equiv$  127.0.0.1 generally called “localhost”
- all broadcasts and multicasts get sent to the loopback - because the sender gets a copy too!
- everything sent to the host's own IP address is sent to the loopback interface

# Virtual Interface (VIF)

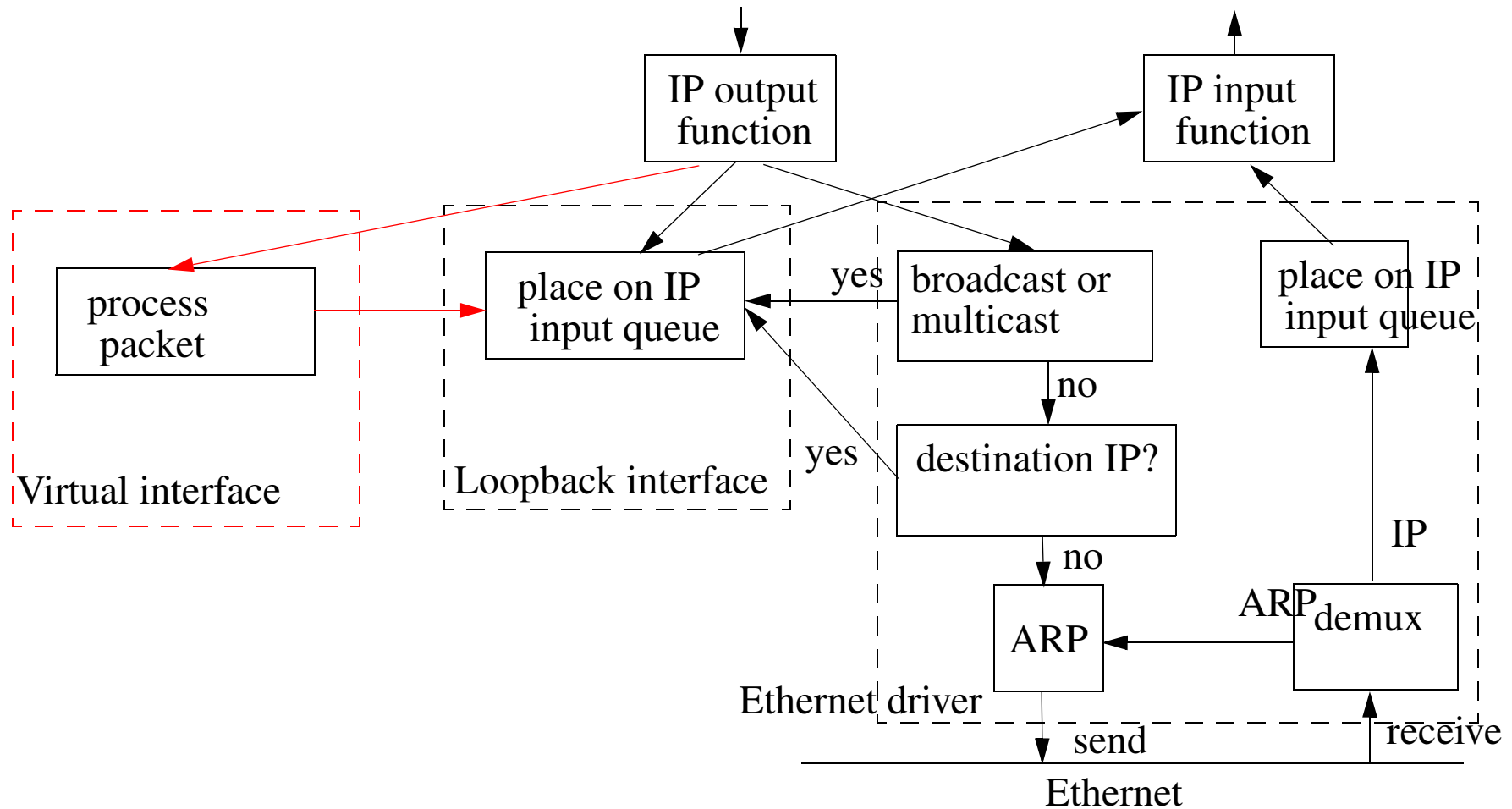

Figure 14: Processing of network packets via a Virtual Interface

# Using VIF for tunneling

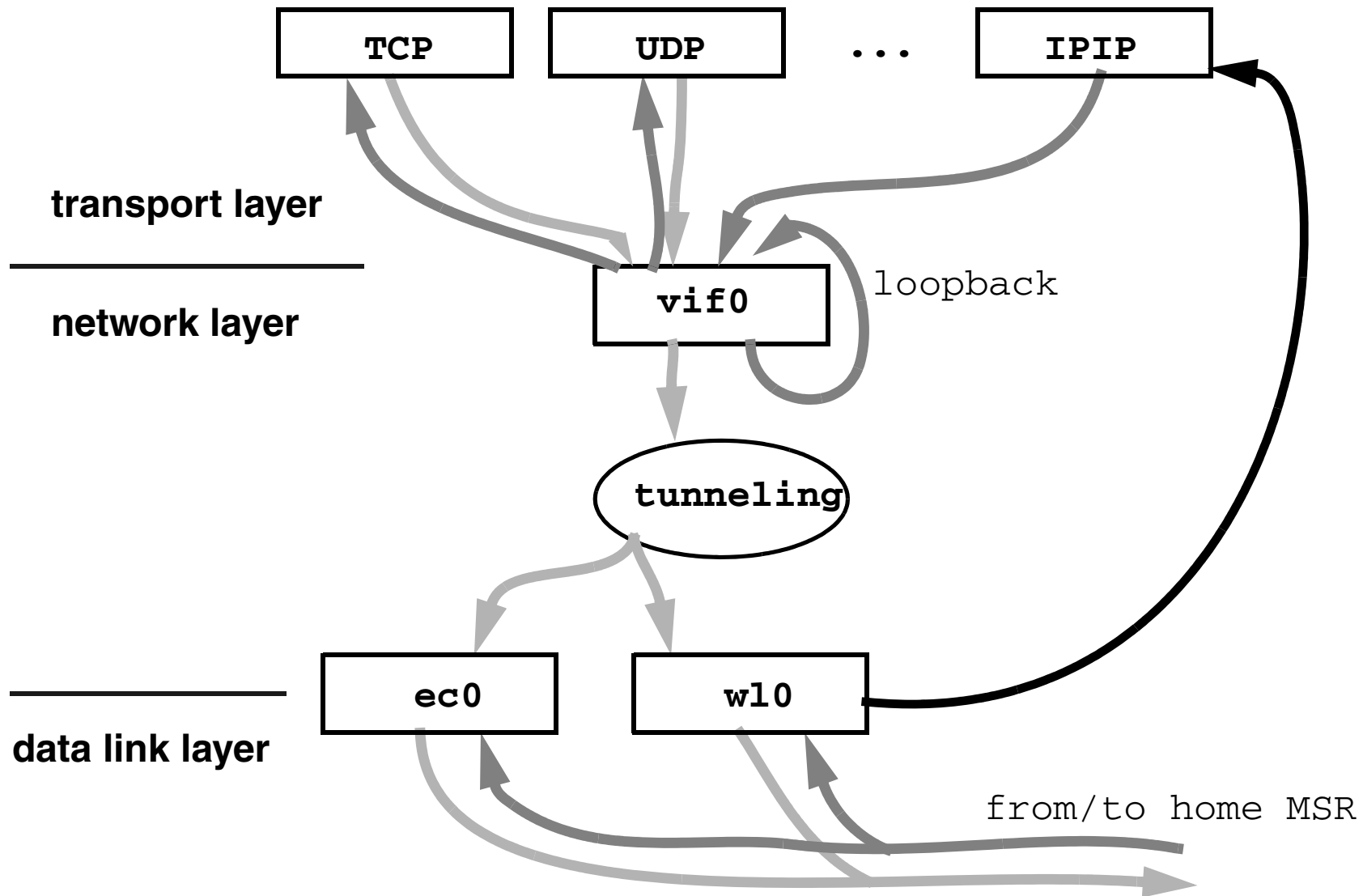

Figure 15: Using a Virtual Interface for Tunneling (IP in IP) adapted from John Ioannidis's thesis

# Wireshark, tcpdump, etc.

Wireshark <http://www.wireshark.org/> is a tool for capturing, visualizing, analyzing, ... network traffic

It builds on the earlier tcpdump program and utilizes the ability to promiscuously listen to a network interface.

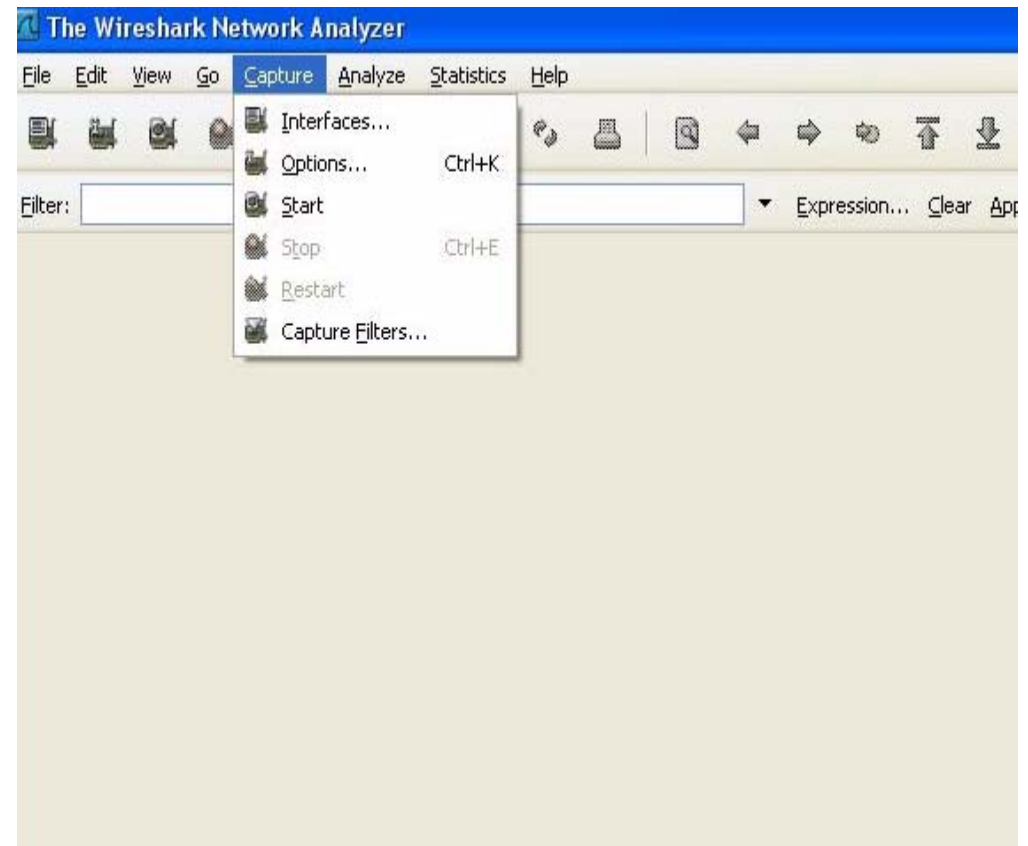
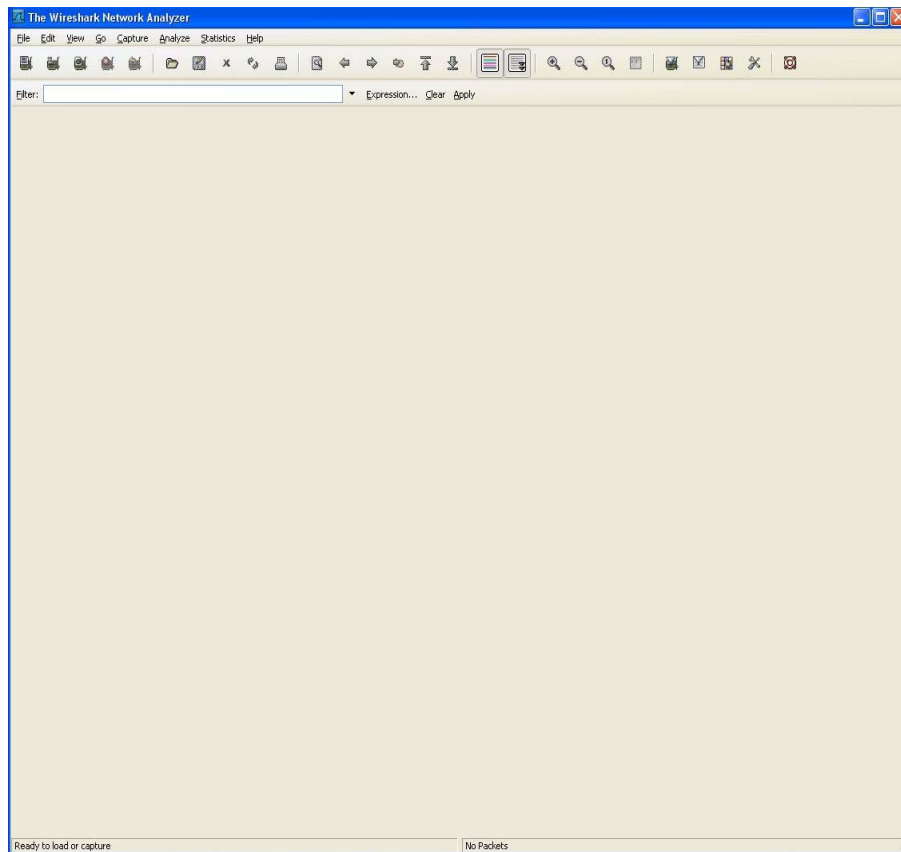

Figure 16: Start the program, then select Capture

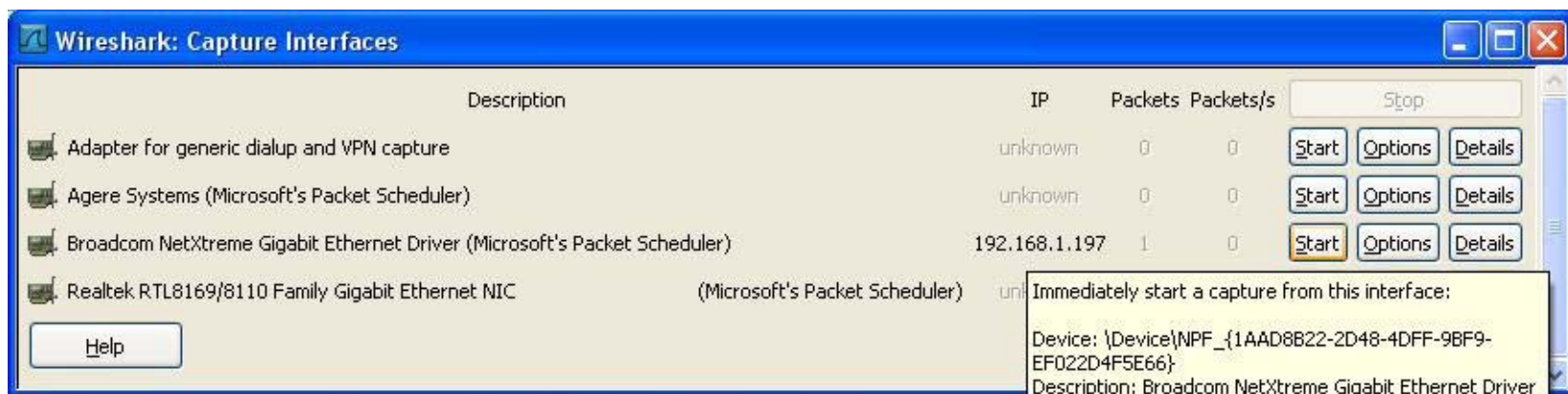

Figure 17: Select the interface

Note that the Microsoft Windows drivers will not allow you to promiscuously listen on a WLAN interface.

The image shows a Wireshark packet capture window. The main pane displays a list of 18 captured packets. The first 9 packets are ARP requests for various IP addresses on the 192.168.1.0/24 network. Packet 10 is a TCP SYN packet from 192.168.32.199 to 192.168.1.197. The remaining 9 packets are ARP requests for other IP addresses. The packet list table is as follows:

| No. | Time     | Source            | Destination   | Protocol | Info                                    |
|-----|----------|-------------------|---------------|----------|---|
| 1   | 0.000000 | Cisco-Li_4d:3d:a2 | Broadcast     | ARP      | who has 192.168.1.219? Tell 192.168.1.1 |
| 2   | 0.000556 | Cisco-Li_4d:3d:a2 | Broadcast     | ARP      | who has 192.168.1.213? Tell 192.168.1.1 |
| 3   | 0.019421 | Cisco-Li_4d:3d:a2 | Broadcast     | ARP      | who has 192.168.1.208? Tell 192.168.1.1 |
| 4   | 0.042448 | Cisco-Li_4d:3d:a2 | Broadcast     | ARP      | who has 192.168.1.206? Tell 192.168.1.1 |
| 5   | 0.043124 | Cisco-Li_4d:3d:a2 | Broadcast     | ARP      | who has 192.168.1.194? Tell 192.168.1.1 |
| 6   | 0.043697 | Cisco-Li_4d:3d:a2 | Broadcast     | ARP      | who has 192.168.1.211? Tell 192.168.1.1 |
| 7   | 0.067420 | Cisco-Li_4d:3d:a2 | Broadcast     | ARP      | who has 192.168.1.212? Tell 192.168.1.1 |
| 8   | 0.090488 | Cisco-Li_4d:3d:a2 | Broadcast     | ARP      | who has 192.168.1.201? Tell 192.168.1.1 |
| 9   | 0.114450 | Cisco-Li_4d:3d:a2 | Broadcast     | ARP      | who has 192.168.1.203? Tell 192.168.1.1 |
| 10  | 0.115043 | 192.168.32.199    | 192.168.1.197 | TCP      | 46571 > ftp [SYN] Seq=0 Len=0 MSS=1460  |
| 11  | 0.115616 | Cisco-Li_4d:3d:a2 | Broadcast     | ARP      | who has 192.168.1.223? Tell 192.168.1.1 |
| 12  | 0.138684 | Cisco-Li_4d:3d:a2 | Broadcast     | ARP      | who has 192.168.1.214? Tell 192.168.1.1 |
| 13  | 0.139433 | Cisco-Li_4d:3d:a2 | Broadcast     | ARP      | who has 192.168.1.202? Tell 192.168.1.1 |
| 14  | 0.162928 | Cisco-Li_4d:3d:a2 | Broadcast     | ARP      | who has 192.168.1.195? Tell 192.168.1.1 |
| 15  | 0.163729 | Cisco-Li_4d:3d:a2 | Broadcast     | ARP      | who has 192.168.1.215? Tell 192.168.1.1 |
| 16  | 0.234449 | Cisco-Li_4d:3d:a2 | Broadcast     | ARP      | who has 192.168.1.222? Tell 192.168.1.1 |
| 17  | 0.235011 | Cisco-Li_4d:3d:a2 | Broadcast     | ARP      | who has 192.168.1.207? Tell 192.168.1.1 |
| 18  | 0.235345 | Cisco-Li_4d:3d:a2 | Broadcast     | ARP      | who has 192.168.1.200? Tell 192.168.1.1 |

Below the packet list, the details pane shows the structure of the first packet (Frame 1):

- Ethernet II, Src: Cisco-Li\_4d:3d:a2 (00:16:b6:4d:3d:a2), Dst: Broadcast (ff:ff:ff:ff:ff:ff)
- Address Resolution Protocol (request)

The hex dump pane shows the raw bytes of the first packet:

```

000  ff ff ff ff ff ff 00 16  b6 4d 3d a2 08 06 00 01  .....M=.....
010  08 00 06 04 00 01 00 16  b6 4d 3d a2 c0 a8 01 01  .....M=.....
020  00 00 00 00 00 00 c0 a8  01 db 00 00 00 04 c0 e3  .....
030  43 20 c1 98 fc 80 00 00  0b 62 6e 87             C......bn.

```

Figure 18: After capturing some packets

# Exporting data to other tools

By exporting the data we can process it with lots of different tools:

- tcpdump (and similar tools),
- Perl, AWK, ... scripts,
- spreadsheets,
- ...
- custom programs



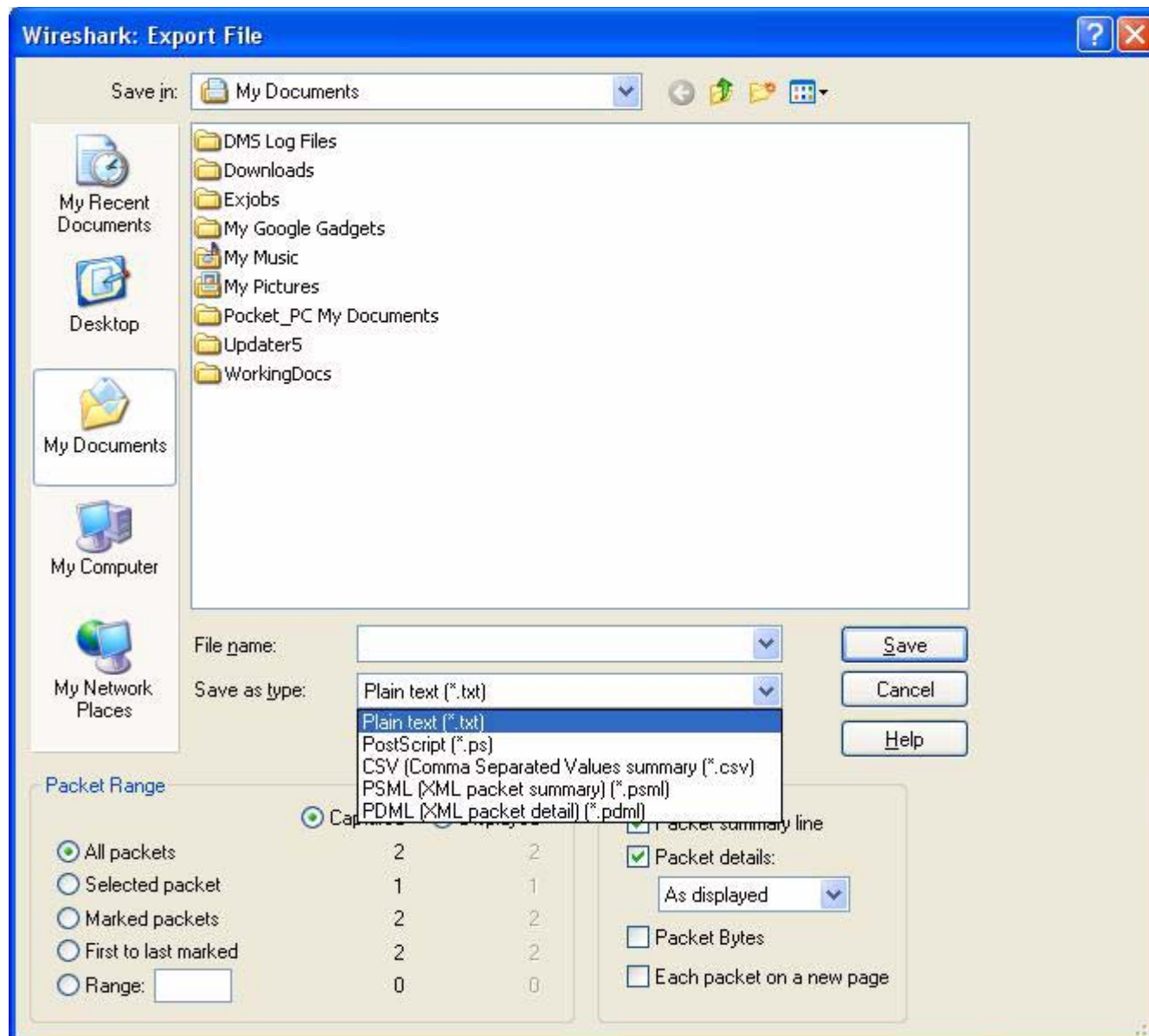

Figure 19: Export the captured traffic

# Comma Separated Values

Example:

"No.", "Time", "Source", "Destination", "Protocol", "Info"

"1", "0.000000", "192.168.1.197", "192.168.1.255", "BROWSER",  
"Host Announcement CCSNONAME, Workstation, Server, NT Workstation"

"2", "2.208042", "Cisco-Li\_4d:3d:a2", "Broadcast", "ARP",  
"Who has 192.168.1.219? Tell 192.168.1.1"

"3", "3.206115", "Cisco-Li\_4d:3d:a2", "Broadcast", "ARP",  
"Who has 192.168.1.219? Tell 192.168.1.1"

"4", "4.206193", "Cisco-Li\_4d:3d:a2", "Broadcast", "ARP",  
"Who has 192.168.1.219? Tell 192.168.1.1"

# Importing in to a Microsoft Excel<sup>1</sup> spreadsheet

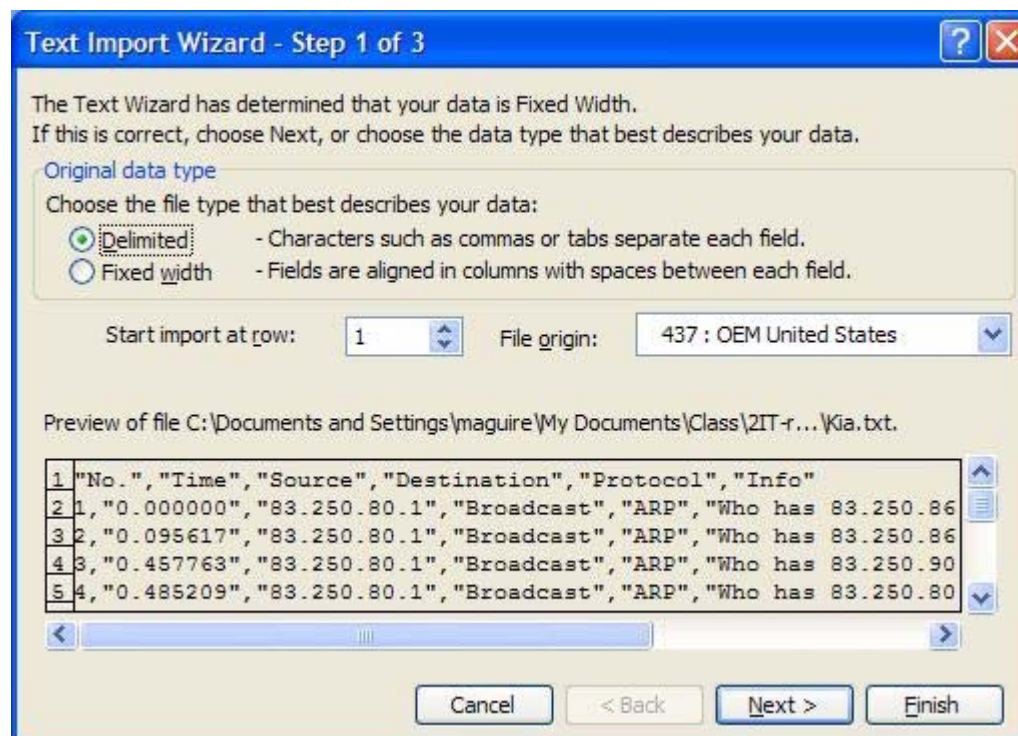

Figure 20: First step after opening a CSV formatted file

1. Similar mechanisms can be used with other spreadsheets

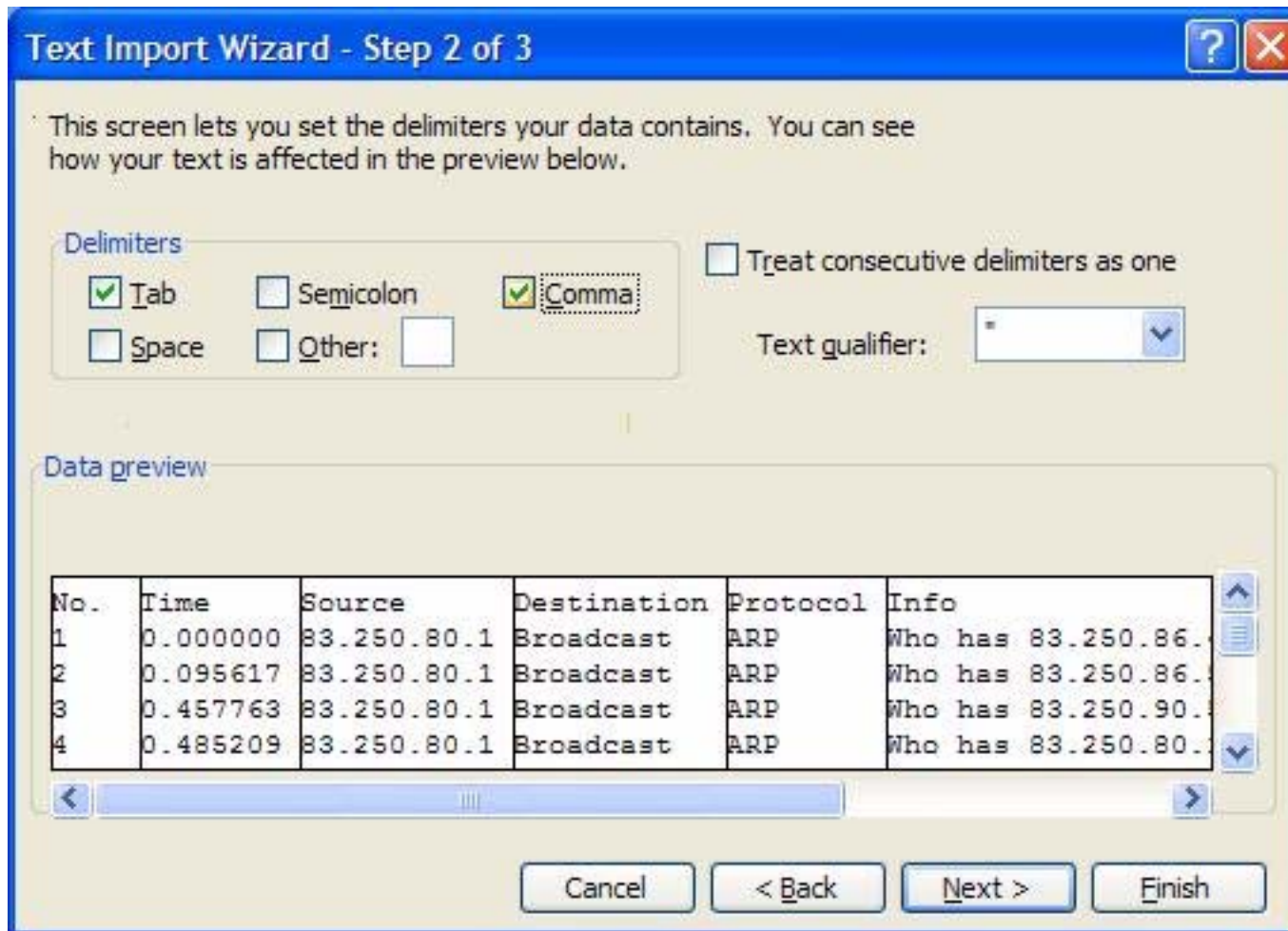

Figure 21: Second step in conversion

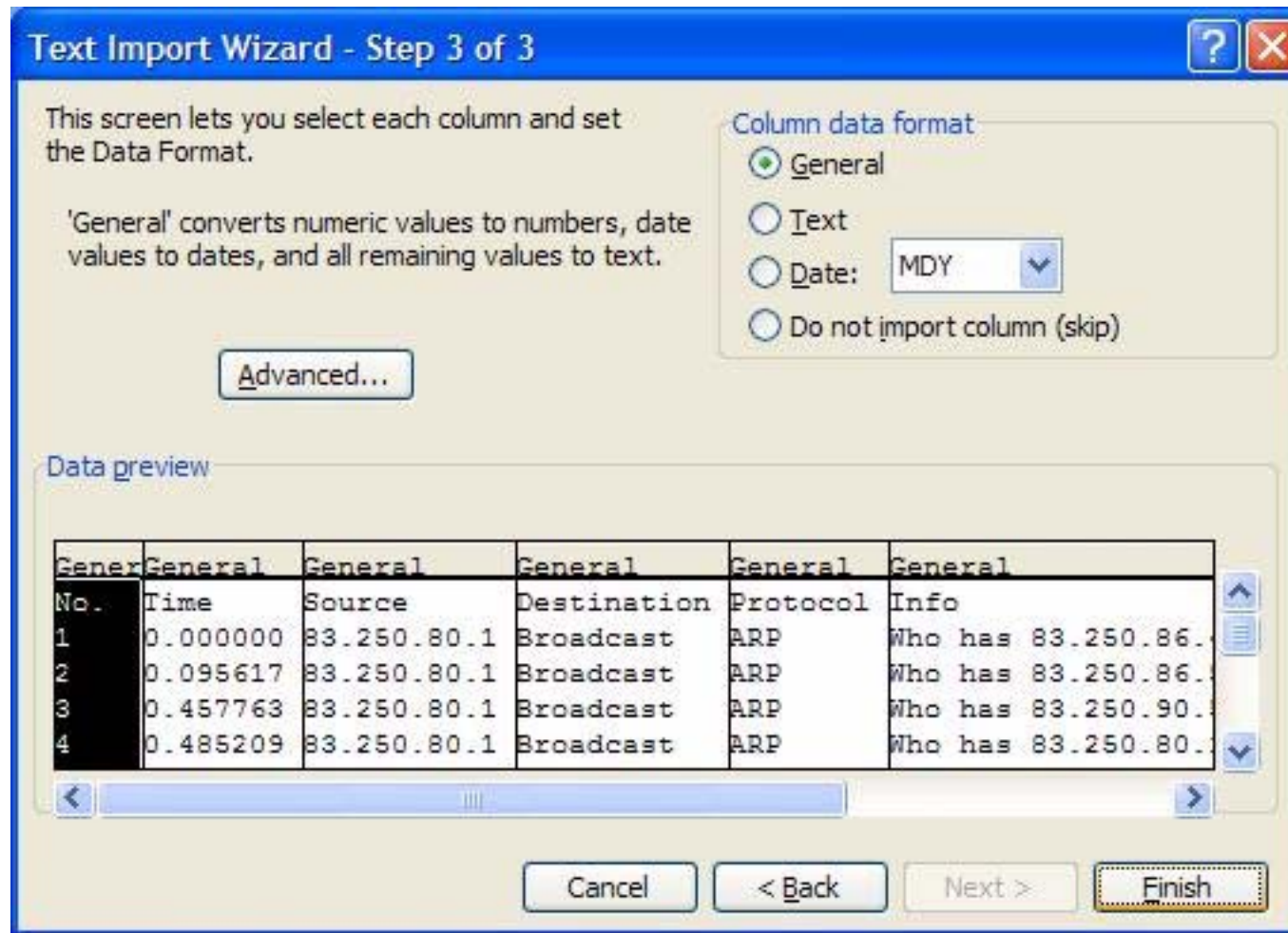
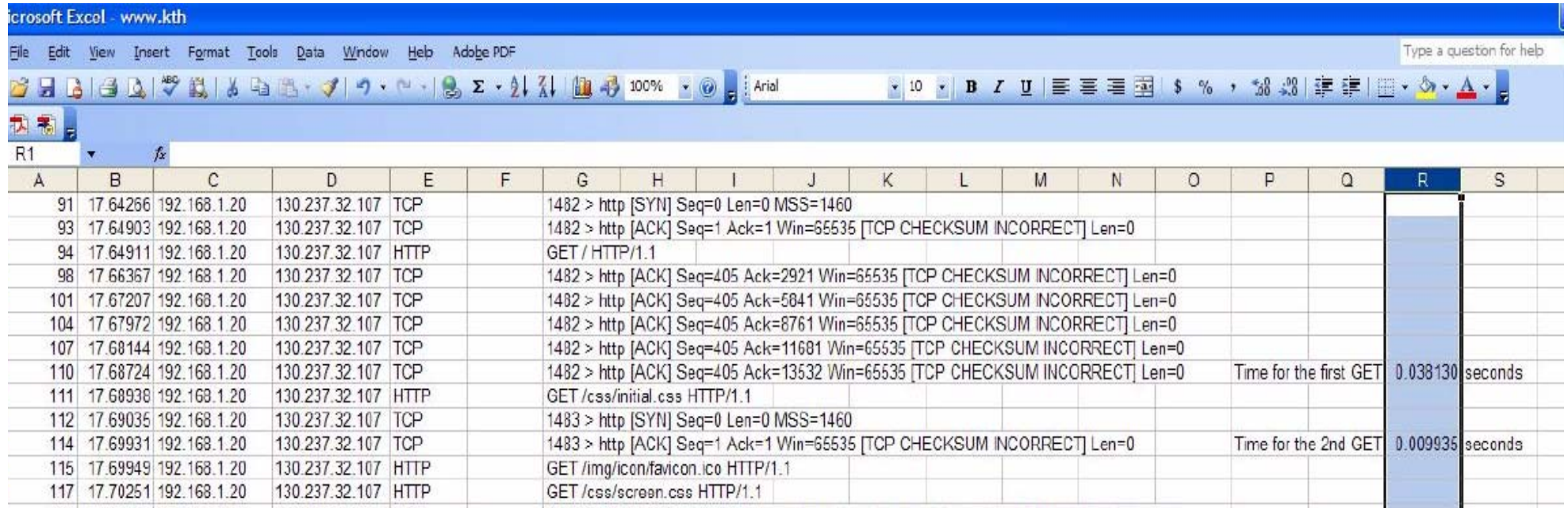

Figure 22: Final step -- Note that in this step if you are using the Swedish language version of Microsoft's Excel - you need to indicate that the "." in the Time column, should be converted to a ",", - otherwise you can not do arithmetic on these values (since they look like strings!!!)

# Example of what can be done



| A   | B        | C            | D              | E    | F | G  | H | I | J | K | L | M | N | O                      | P | Q | R        | S       |
|-----|----------|--------------|----------------|------|---|--|---|---|---|---|---|---|---|------------------------|---|---|----------|---------|
| 91  | 17.64266 | 192.168.1.20 | 130.237.32.107 | TCP  |   | 1482 > http [SYN] Seq=0 Len=0 MSS=1460                                       |   |   |   |   |   |   |   |                        |   |   |          |         |
| 93  | 17.64903 | 192.168.1.20 | 130.237.32.107 | TCP  |   | 1482 > http [ACK] Seq=1 Ack=1 Win=65535 [TCP CHECKSUM INCORRECT] Len=0       |   |   |   |   |   |   |   |                        |   |   |          |         |
| 94  | 17.64911 | 192.168.1.20 | 130.237.32.107 | HTTP |   | GET / HTTP/1.1   |   |   |   |   |   |   |   |                        |   |   |          |         |
| 98  | 17.66367 | 192.168.1.20 | 130.237.32.107 | TCP  |   | 1482 > http [ACK] Seq=405 Ack=2921 Win=65535 [TCP CHECKSUM INCORRECT] Len=0  |   |   |   |   |   |   |   |                        |   |   |          |         |
| 101 | 17.67207 | 192.168.1.20 | 130.237.32.107 | TCP  |   | 1482 > http [ACK] Seq=405 Ack=5841 Win=65535 [TCP CHECKSUM INCORRECT] Len=0  |   |   |   |   |   |   |   |                        |   |   |          |         |
| 104 | 17.67972 | 192.168.1.20 | 130.237.32.107 | TCP  |   | 1482 > http [ACK] Seq=405 Ack=8761 Win=65535 [TCP CHECKSUM INCORRECT] Len=0  |   |   |   |   |   |   |   |                        |   |   |          |         |
| 107 | 17.68144 | 192.168.1.20 | 130.237.32.107 | TCP  |   | 1482 > http [ACK] Seq=405 Ack=11681 Win=65535 [TCP CHECKSUM INCORRECT] Len=0 |   |   |   |   |   |   |   |                        |   |   |          |         |
| 110 | 17.68724 | 192.168.1.20 | 130.237.32.107 | TCP  |   | 1482 > http [ACK] Seq=405 Ack=13632 Win=65535 [TCP CHECKSUM INCORRECT] Len=0 |   |   |   |   |   |   |   | Time for the first GET |   |   | 0.038130 | seconds |
| 111 | 17.68938 | 192.168.1.20 | 130.237.32.107 | HTTP |   | GET /css/initial.css HTTP/1.1  |   |   |   |   |   |   |   |                        |   |   |          |         |
| 112 | 17.69035 | 192.168.1.20 | 130.237.32.107 | TCP  |   | 1483 > http [SYN] Seq=0 Len=0 MSS=1460                                       |   |   |   |   |   |   |   |                        |   |   |          |         |
| 114 | 17.69931 | 192.168.1.20 | 130.237.32.107 | TCP  |   | 1483 > http [ACK] Seq=1 Ack=1 Win=65535 [TCP CHECKSUM INCORRECT] Len=0       |   |   |   |   |   |   |   | Time for the 2nd GET   |   |   | 0.009935 | seconds |
| 115 | 17.69949 | 192.168.1.20 | 130.237.32.107 | HTTP |   | GET /img/icon/favicon.ico HTTP/1.1   |   |   |   |   |   |   |   |                        |   |   |          |         |
| 117 | 17.70251 | 192.168.1.20 | 130.237.32.107 | HTTP |   | GET /css/screen.css HTTP/1.1   |   |   |   |   |   |   |   |                        |   |   |          |         |

Figure 23: Use spreadsheet operations over the values

# Using a Perl script

```
#!/usr/bin/perl -w
# each input line consists of a triple: Time,Source,RSSI
# separate the file based upon making a file for each source containing only the Time and RSSI
#
# 2007.12.27 G. Q. Maguire Jr. and M. E. Noz
#
# Security blankets - Perl authors claim programs are unsafe without this
# This only removes directories that have no files in them
#Use only perl library
#@INC = $INC[$#INC - 1];
#die "Perl library is writable by the world!\n" if $< && -W $INC[0];

$ENV{'IFS'} = '' if $ENV{'IFS'};
umask 002;

# get the main directory paths
$project_dir = '/home/noz';
$filename = 'all-time-source-RSSId.csv';
#$filename = 'all-time.small';
$sourcename = '';
$sourcename1 = '';
$time = '';
$RRSID = '';
$count = 0;

&create_tmp_file;

#open the data file for reading
open(DATA_FILE, $filename) || die "Can't open data file: $!\n";

while ($varrec = <DATA_FILE>) {
    if ($varrec =~ /^#/) {
        $count = 1;
        next;
    }
    else {
        chop($varrec);
        print "count is $count\n";
#        print "varrec is $varrec\n";
        ($time, $sourcename, $RSSId) = split(/,/, $varrec);
#        print "time is $time, sourcename is $sourcename, RSSId is $RSSId\n";
        if ($count == 1) {
            $sourcename1=$sourcename;

```

```

print PTMP "$time $RSSId\n";
$count++;
print "sourcename is $sourcename; sourcename1 is $sourcename1 \n";
}
else {
if ($sourcename =~ $sourcename1) {
    print PTMP "$time $RSSId\n";
}
else {
    print "sourcename is $sourcename, old sourcename is $sourcename1\n";
    close PTMP;
    chmod 0664, '/tmp/ptmp';
    system("mv /tmp/ptmp $sourcename1");
    $sourcename1 = $sourcename;
    &create_tmp_file;
    print PTMP "$time $RSSId\n";
}
}
}
}
close PTMP;
chmod 0664, '/tmp/ptmp';
system("mv /tmp/ptmp $sourcename1");

close DATA_FILE;

sub create_tmp_file {
#   open(PTMP, ">/tmp/ptmptmp$$") || die "Can't create tmp file $!\n";
#   close (PTMP);
#   $locked = link("/tmp/ptmptmp$$", '/tmp/ptmp');
#   unlink "/tmp/ptmptmp$$";
#   $locked || die "Can't lock temporary file.\n";
    open(PTMP, ">/tmp/ptmp") || die "Can't open tmp file $! for writing\n";
}

```

This script process captured IEEE 802.11 packets to put measurements of the different sources into their own files, based upon the source MAC address. (In this case the program assumes that the file has already been sorted based upon the source MAC address.)



# Choosing which columns to display

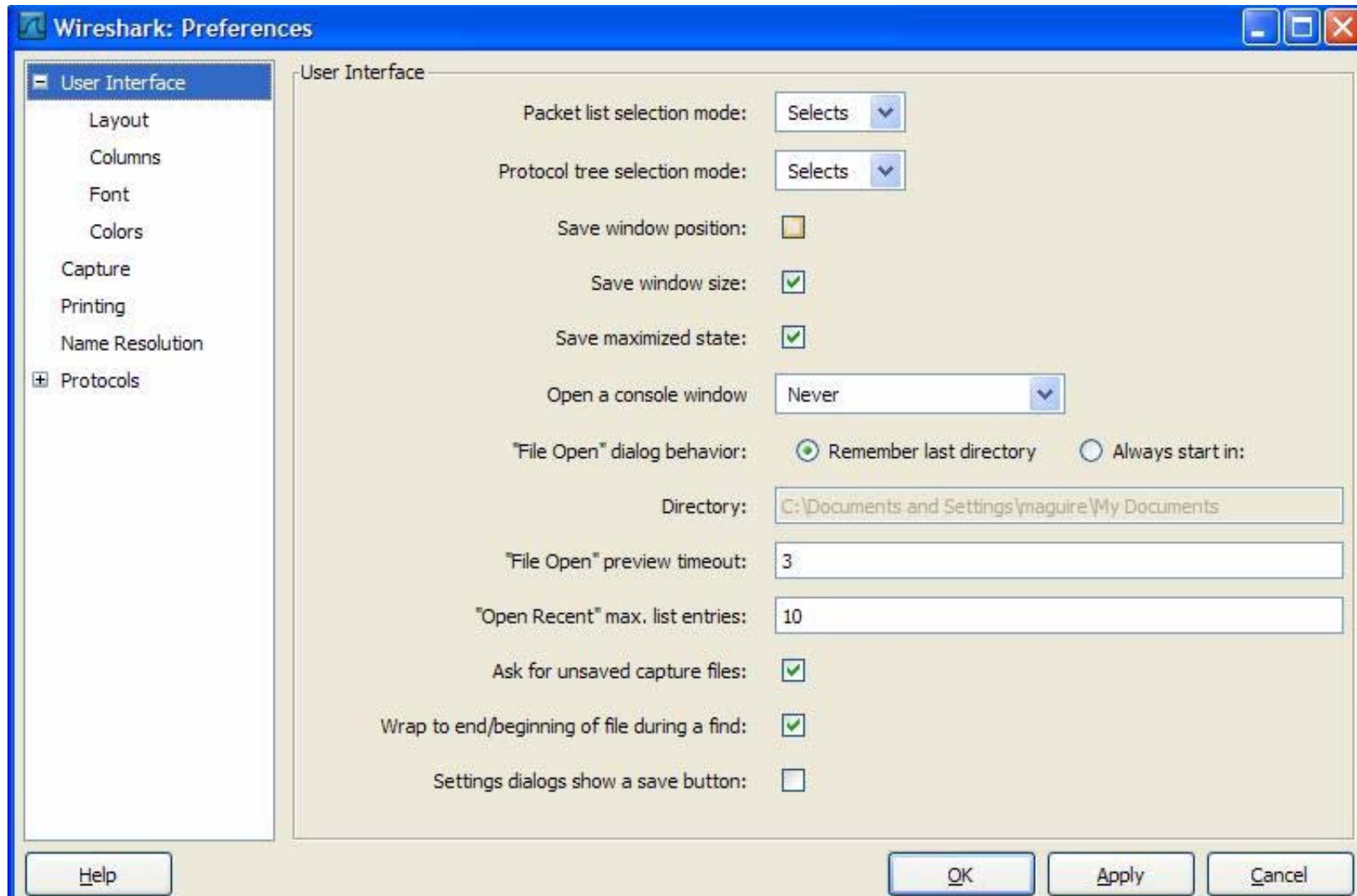

Figure 24: Set your preferences for the User Interface

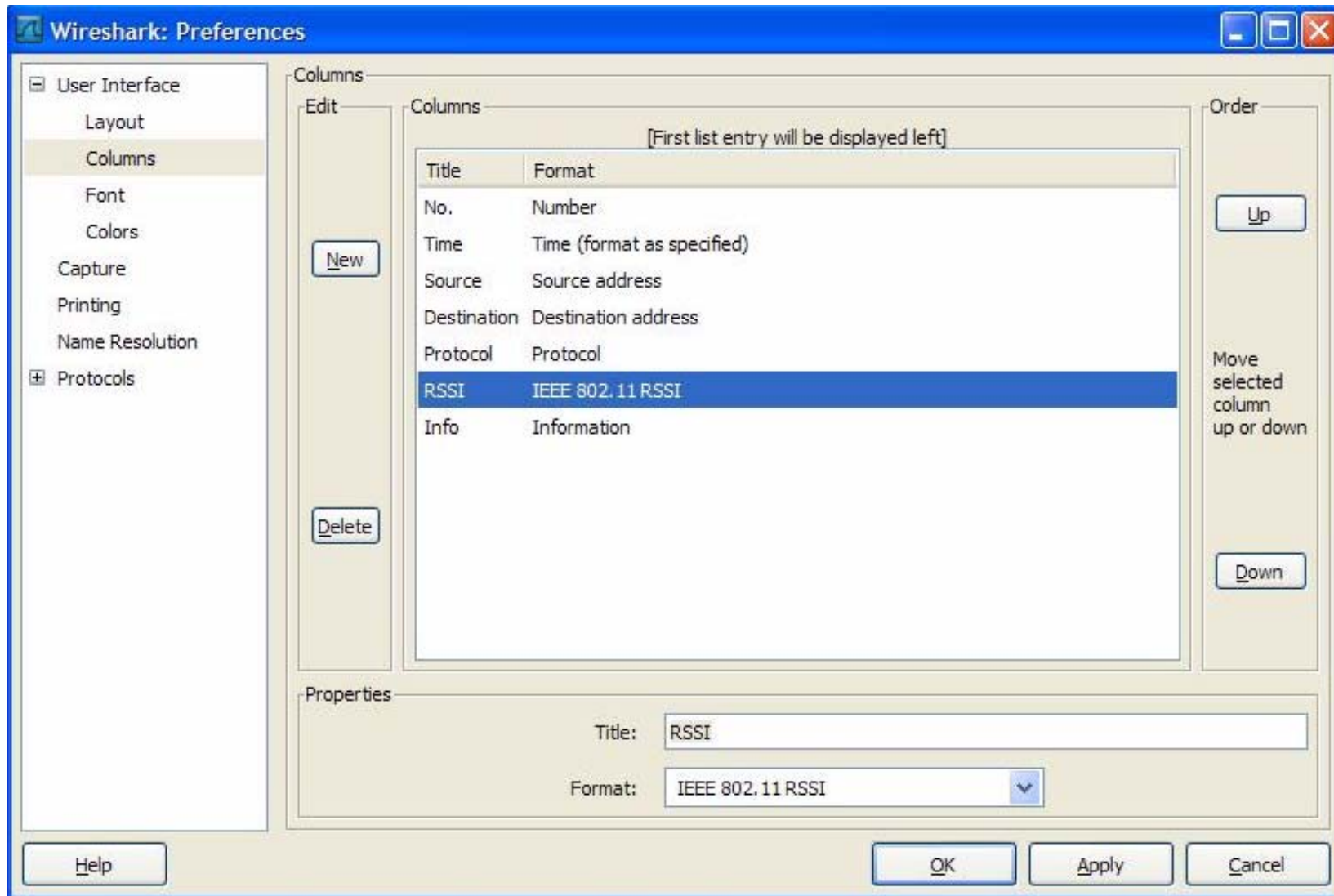

Figure 25: Add a column and place it in the desired column position

| No. ↓ | Time     | Source            | Destination | Protocol | RSSI | Info                                   |
|-------|----------|-------------------|-------------|----------|------|--|
| 1     | 0.000000 | D-Link_9e:87:29   | Broadcast   | ARP      |      | who has 192.168.1.8? Tell 192.168.1.1  |
| 2     | 0.999919 | D-Link_9e:87:29   | Broadcast   | ARP      |      | who has 192.168.1.8? Tell 192.168.1.1  |
| 3     | 1.999836 | D-Link_9e:87:29   | Broadcast   | ARP      |      | who has 192.168.1.8? Tell 192.168.1.1  |
| 4     | 3.543299 | D-Link_9e:87:29   | Broadcast   | ARP      |      | who has 192.168.1.8? Tell 192.168.1.1  |
| 5     | 4.542636 | D-Link_9e:87:29   | Broadcast   | ARP      |      | who has 192.168.1.8? Tell 192.168.1.1  |
| 6     | 5.542557 | D-Link_9e:87:29   | Broadcast   | ARP      |      | who has 192.168.1.8? Tell 192.168.1.1  |
| 7     | 6.542477 | D-Link_9e:87:29   | Broadcast   | ARP      |      | who has 192.168.1.8? Tell 192.168.1.1  |
| 8     | 7.542390 | D-Link_9e:87:29   | Broadcast   | ARP      |      | who has 192.168.1.8? Tell 192.168.1.1  |
| 9     | 8.297723 | LgElectr_0b:5e:61 | Broadcast   | ARP      |      | who has 192.168.1.2? Tell 192.168.1.20 |

Figure 26: Save your parameters and restart the program to use the newly configured user interface

# IP addresses

## Address types

- Unicast = one-to-one
- Multicast = one-to-many
- Broadcast = one-to-all

32 bit address divided into two parts:

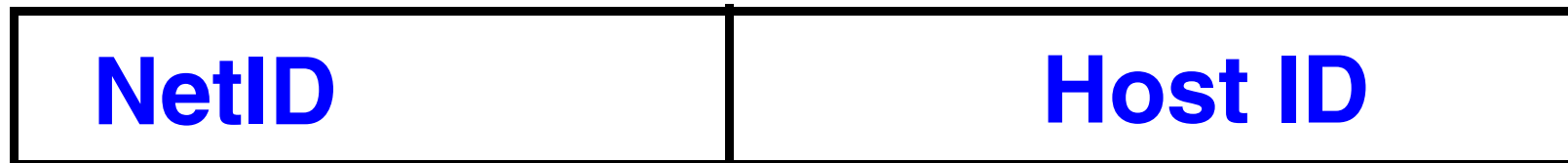

Figure 27: IP address format

Note that although we refer to it as the Host ID part of the address, it is really the [address of an interface](#).

Dotted decimal notation: write each byte as a decimal number, separate each of these with a “.” i.e., 10000010 11101101 00100000 00110011  $\Rightarrow$  130.237.32.51  
or in hexadecimal as: 0x82ED2033

# Classful addressing

Classically the address range was divided into classes:

| Class | NetID     |                | Range (dotted decimal notation)            | host ID                      |
|-------|-----------|----------------|--|------------------------------|
| A     | 0         | + 7-bit NetID  | 0.0.0.0 to <b>127.255.255.255</b>          | 24 bits of host ID           |
| B     | 1 0       | + 14-bit NetID | <b>128.0.0.0</b> to <b>191.255.255.255</b> | 16 bits of host ID           |
| C     | 1 1 0     | + 21-bit NetID | <b>192.0.0.0</b> to <b>223.255.255.255</b> | 8 bits of host ID            |
| D     | 1 1 1 0   |                | <b>224.0.0.0</b> to <b>239.255.255.255</b> | 28 bits of Multicast address |
| E     | 1 1 1 1 0 |                | <b>240.0.0.0</b> to <b>247.255.255.255</b> | Reserved for future use      |

- Globally addressable IP addresses must be unique
  - later in the course we will see how NATs affect this
- addresses roughly  $2^7 * 2^{24} + 2^{14} * 2^{16} + 2^{21} * 2^8 = 3,758,096,384$  **interfaces** (**not** the number of hosts)
- in 1983 this seemed like a lot of addresses
- problems with the size of the blocks  $\Rightarrow$  lots of wasted addresses
  - lead to classless addressing!

# Classless addressing: Subnetting IP networks

Often we want to “subnet” - i.e., divide the network up into multiple networks:

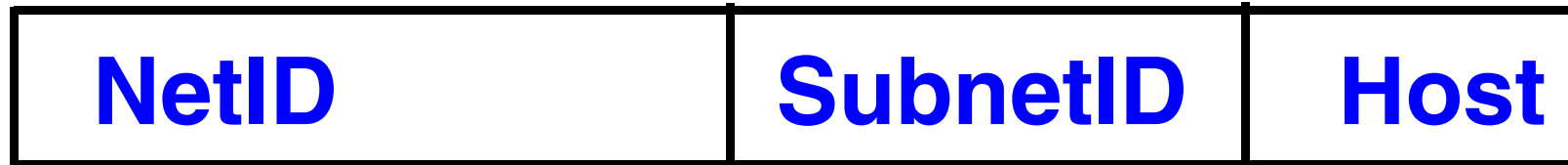

Figure 28: IP addresses and subnetting

Although the Subnet field is shown as a field which is separate from the Host field, it could actually be divided on a bit by bit basis; this is done by a **Subnet Mask**.

A common practice to avoid wasting large amounts of address space is to use Classless Interdomain Routing (CIDR) also called “supernetting” {see §10.8 of Steven’s Vol. 1 and RFCs 1518[20] and 1519[21]}.

# Special Case IP Addresses

| IP Address   |                 |               | Can appear as |             | Description   |
|--------------|-----------------|---------------|---------------|-------------|---|
| net ID       | subnet ID       | host ID       | source?       | destination |   |
| 0            |                 | 0             | OK            | never       | <b>this</b> host on <b>this</b> net                         |
| 0            |                 | <b>hostid</b> | OK            | never       | specified host on <b>this</b> net                           |
| 127          |                 | <b>any</b>    | OK            | OK          | loopback address  |
| -1           |                 | -1            | never         | OK          | limited broadcast (never forwarded)                         |
| <b>netid</b> |                 | -1            | never         | OK          | net-directed broadcast to <b>netid</b>                      |
| <b>netid</b> | <b>subnetid</b> | -1            | never         | OK          | subnet-directed broadcast to <b>netid</b> , <b>subnetid</b> |
| <b>netid</b> | -1              | -1            | never         | OK          | all-subnets-directed broadcast to <b>netid</b>              |

Thus for every subnet - the zero host ID address refers to **this net** and the all ones host ID is a **subnet broadcast** address; this uses up two addresses from every subnet's address range.

# Subnet mask

32 bit value with a 1 for NetID + subnetID, 0 for HostID

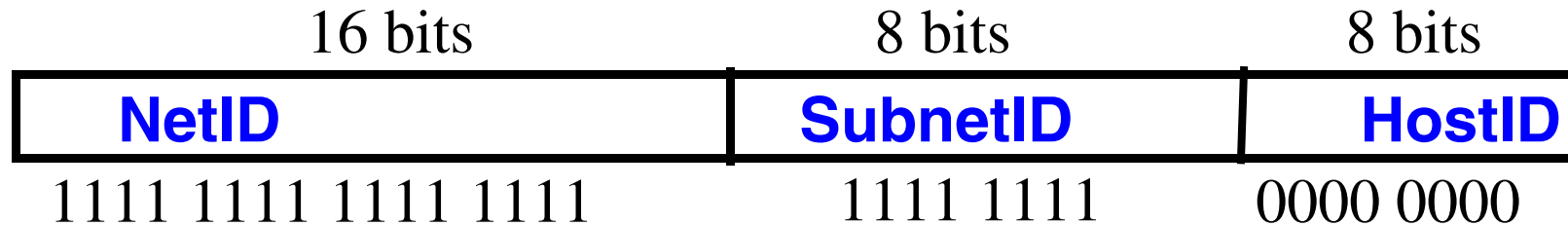
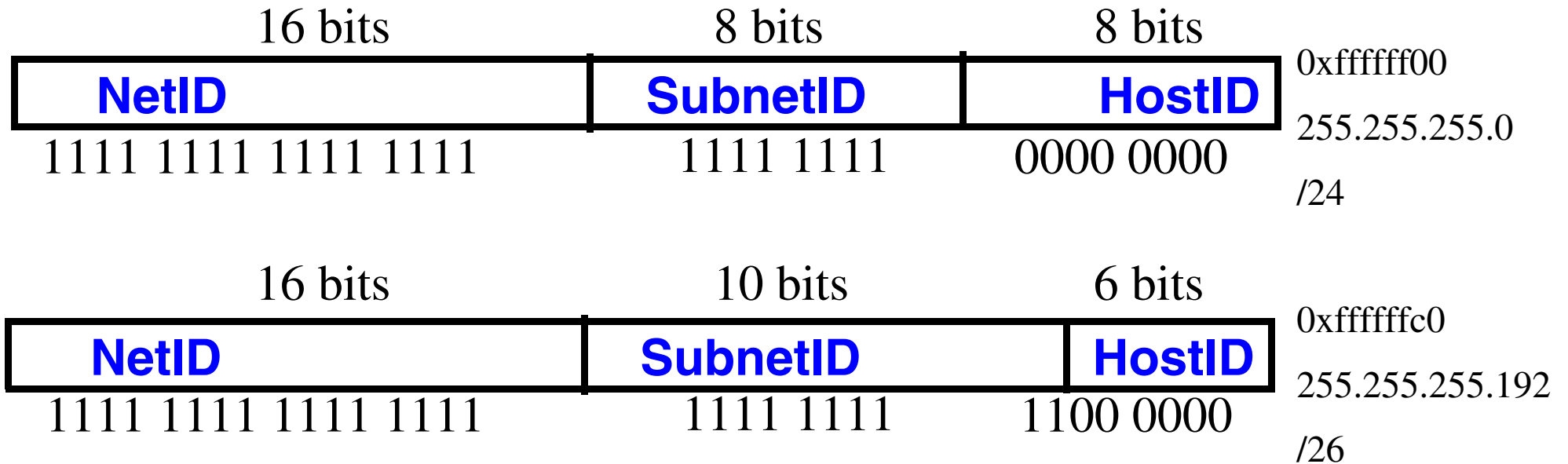

Figure 29: Class B address with a 8 bit subnet address

2 different class B subnet arrangements





# Classless Inter-Domain Routing (CIDR)

## Slash notation

| Length (CIDR) | Address mask | Notes                | Length (CIDR) | Address mask | Notes     |
|---------------|--------------|----------------------|---------------|--------------|-----------|
| /0            | 0.0.0.0      | All 0's<br>≡ no mask | /8            | 255.0.0.0    | ≡ Class A |
| /1            | 128.0.0.0    |                      | /9            | 255.128.0.0  |           |
| /2            | 192.0.0.0    |                      | /10           | 255.192.0.0  |           |
| /3            | 224.0.0.0    |                      | /11           | 255.224.0.0  |           |
| /4            | 240.0.0.0    |                      | /12           | 255.240.0.0  |           |
| /5            | 248.0.0.0    |                      | /13           | 255.248.0.0  |           |
| /6            | 252.0.0.0    |                      | /14           | 255.252.0.0  |           |
| /7            | 254.0.0.0    |                      | /15           | 255.254.0.0  |           |

## Slash notation continued

| Length (CIDR) | Address mask  | Notes     | Length (CIDR) | Address mask    | Notes                           |
|---------------|---------------|-----------|---------------|-----------------|---------------------------------|
| /16           | 255.255.0.0   | ≡ Class B | /24           | 255.255.255.0   | ≡ Class C                       |
| /17           | 255.255.128.0 |           | /25           | 255.255.255.128 |                                 |
| /18           | 255.255.192.0 |           | /26           | 255.255.255.192 |                                 |
| /19           | 255.255.224.0 |           | /27           | 255.255.255.224 |                                 |
| /20           | 255.255.240.0 |           | /28           | 255.255.255.240 |                                 |
| /21           | 255.255.248.0 |           | /29           | 255.255.255.248 |                                 |
| /22           | 255.255.252.0 |           | /30           | 255.255.255.252 |                                 |
| /23           | 255.255.254.0 |           | /31           | 255.255.255.254 |                                 |
|               |               |           | /32           | 255.255.255.255 | All 1's<br>(host specific mask) |

# IP address assignments

Internet Service Providers (ISPs) should contact their upstream registry or their appropriate Regional Internet Registries (RIR) at one of the following addresses:

| Region   |   |
|--|---|
| APNIC (Asia-Pacific Network Information Center)                | <a href="http://www.apnic.net">http://www.apnic.net</a>                               |
| ARIN (American Registry for Internet Numbers )                 | <a href="http://www.arin.net">http://www.arin.net</a>                                 |
| RIPE NCC (Réseaux IP Européens)                                | <a href="http://www.ripe.net">http://www.ripe.net</a>                                 |
| LANIC (Latin America and Caribbean Network Information Centre) | <a href="http://www.lacnic.net/en/index.html">http://www.lacnic.net/en/index.html</a> |
| AfriNIC (Africa NIC)   | <a href="http://www.afrinic.net/">http://www.afrinic.net/</a>                         |

# Private addresses

Private addresses - these IP addresses are for strictly **private** use:

| Class | Netids                   | block |
|-------|--------------------------|-------|
| A     | 10.                      | 1     |
| B     | 172.16 to 172.31         | 16    |
| C     | 192.168.0 to 192.168.255 | 256   |

For an example of how these private addresses are used **within** an organization

See: <http://www.lan.kth.se/norm/priv-net-usage.txt>

# Problems with the dual functions of IP addresses

Unfortunately an IP address has dual functions:

- **Network ID** portion indicates a **location** in the network
    - i.e., the network ID binds the address to a location in the network topology
    - CIDR and hierarchical address prefixes - allow for recursive subdivision of the topology
  - **Host ID** portion identifies an **interface** - often used as a **node identifier**
    - Unfortunately network connections are bound to these identifiers
    - Specifically TCP/UDP sockets are identified by the endpoint IP address (and port numbers)
    - DNS returns one or more IP addresses for new connections
- ⇒ This is bad for **mobility** and **multi-homing** (see textbook figure 4.12 on pg. 95)
- If a host changes its point of network attachment it must change its identity
    - Later we will see how Mobile IP addresses this problem
  - Host with multiple interfaces are limited in how they can use them
    - Later we will see how SCTP addresses part of this problem

The result has been that multiple and dynamic addresses are difficult to handle and lead to a number of efforts to rethink how addresses are used.

# ifconfig, route, and netstat Commands

- `ifconfig`: to configure interface.
- `route`: to update routing table.
- `netstat`: to get interface and routing information.

For example: to configure interface, add an network and add a gateway:

```
root# ifconfig eth0 192.71.20.115 netmask 255.255.255.0 up
root# route add -net 192. 71.20.0 netmask 255.255.255.0 eth0
root# route add default gw 192.71.20.1 eth0
```

We will discuss these commands in more detail in following lectures and in the recitations.

Note: These commands being replaced in Linux OSs by the use of the "ip" command, as it handles both IPv4 and IPv6.

Another useful command on Linux systems is "lsof" - LiSt Open Files - since network sockets are files; useful to see what process has what sockets open.

# Standardization Organizations

The most relevant to the Internet are:

- Internet Society (ISOC)
  - Internet Engineering Task Force (IETF)
- World-wide-web consortium (W3C)
- International Standards Organization (ISO)
- International Telecommunications Union - Telecommunication Standards Sector (ITU-T)
- Institute of Electrical and Electronics Engineers (IEEE)
- ...

Read in the textbook sections 1.4 and 1.5.

# Summary

- Course Introduction
- Internet Basics
  - Multiplexing and demultiplexing
  - Datagrams
- Link Layer Protocols for the Internet
  - Ethernet
  - SLIP, PPP
- IP: Internet Protocol
  - IP addressing
  - Subnetting



# W. Richard Stevens

- Born in Luanshya, Northern Rhodesia (now Zambia) in 1951
- Died on September 1, 1999
- He studied Aerospace Engineering, Systems Engineering (image processing major, physiology minor)
- flight instructor and programmer
- His many books helped many people to understand and use TCP/IP
  - UNIX Network Programming, Prentice Hall, 1990.
  - Advanced Programming in the UNIX Environment, Addison-Wesley, 1992.
  - TCP/IP Illustrated, Volume 1: The Protocols, Addison-Wesley, 1994.
  - TCP/IP Illustrated, Volume 2: The Implementation, Addison-Wesley, 1995.
  - TCP/IP Illustrated, Volume 3: TCP for Transactions, HTTP, NNTP, and the UNIX Domain Protocols, Addison-Wesley, 1996.
  - UNIX Network Programming, Volume 1, Second Edition: Networking APIs: Sockets and XTI, Prentice Hall, 1998.
  - UNIX Network Programming, Volume 2, Second Edition: Interprocess Communications, Prentice Hall, 1999.

# References

- [1] Barry M. Leiner, Vinton G. Cerf, David D. Clark, Robert E. Kahn, Leonard Kleinrock, Daniel C. Lynch, Jon Postel, Larry G. Roberts, and Stephen Wolff, “A Brief History of the Internet”, On The Internet, May/June 1997  
<http://www.isoc.org/oti/articles/0597/leiner.html>
- [2] R. Kahn, Communications Principles for Operating Systems. Internal BBN memorandum, Jan. 1972.
- [3] V. Cerf and R. Kahn, “A protocol for packet network interconnection”, IEEE Transactions on Communications Technology, Vol. COM-22, Number 5, May 1974, pp. 627-641.  
[http://global.mci.com/us/enterprise/insight/cerfs\\_up/technical\\_writings/protocol\\_paper/](http://global.mci.com/us/enterprise/insight/cerfs_up/technical_writings/protocol_paper/)
- [4] Jerome H. Saltzer, David P. Reed, David D. Clark, “End-To-End Arguments In System Design” In ACM Transactions on Computer Systems, V2, #4, Nov. 1984, pages 277-288  
<http://citeseer.ist.psu.edu/saltzer84endtoend.html>
- [5] David D. Clark and Marjory S. Blumenthal, “Rethinking the Design of the Internet: The end to end arguments vs. the brave new world”, In ACM Transactions on Internet Technology, Vol 1, No 1, August 2001, pp 70-109.  
[http://www.ana.lcs.mit.edu/papers/PDF/Rethinking\\_2001.pdf](http://www.ana.lcs.mit.edu/papers/PDF/Rethinking_2001.pdf)
- [6] D. Clark, J. Wroclawski, K. Sollins, and R. Braden, “Tussle in Cyberspace: Defining Tomorrow’s Internet”, Proceedings of Sigcomm 2002.  
<http://www.acm.org/sigs/sigcomm/sigcomm2002/papers/tussle.pdf>
- [7] Wendell Odom and Rick McDonald, Routers and Routing Basics CCNA 2 Companion Guide (Cisco Networking Academy Program), 1st edition, Cisco Press, 2006 ISBN 1-587113-166-8.
- [8] James D. Carlson, “PPP Design, Implementation, and Debugging”, Second edition, Addison-Wesley, 2000, ISBN 0-201-70053-0
- [9] Gerald Combs, Wireshark web page, <http://www.wireshark.org/>, last accessed 4 January 2008 15:06:48 PM EST
- [10] Hewlett-Packard Company Annual Report, 2006, page 60
- [11] Hewlett-Packard Company Form 10-K, 2007, page 60

- [12] Van Jacobson, "If a Clean Slate is the solution what was the problem?", Stanford Clean Slate Seminar, slide 26: "Digression on Implicit vs. Explicit Information", February 27, 2006 <http://cleanslate.stanford.edu/seminars/jacobson.pdf>
- [13] J. Reynolds and J. Postel, Assigned Numbers, Request for Comments: 1700 (RFC 1700), USC/Information Sciences Institute, October 1994.
- [14] J. Postel, "User Datagram Protocol", RFC 768, USC/Information Sciences Institute, August 1980.
- [15] International Standards Organization, "Protocol for Providing the Connectionless-Mode Network Services", RFC 926, ISO, December 1984.
- [16] J. Romkey, A nonstandard for transmission of IP Datagrams over serial lines: SLIP, Request for Comments (RFC) 1055, IETF, Network Working Group, June 1988
- [17] V. Jacobson, Compressing TCP/IP Headers for Low-Speed Serial Links, RFC 1144, IETF, Network Working Group, February 1990
- [18] W. Simpson, The Point-to-Point Protocol (PPP) for the Transmission of Multi-protocol Datagrams over Point-to-Point Links, RFC 1331, IETF, Network Working Group, May 1992
- [19] G. McGregor, The PPP Internet Protocol Control Protocol (IPCP), RFC 1332, IETF, Network Working Group, May 1992
- [20] Y. Rekhter and T. Li (Editors), An Architecture for IP Address Allocation with CIDR, RFC 1518, IETF, Network Working Group, September 1993
- [21] V. Fuller, T. Li, J. Yu, and K. Varadhan, Classless Inter-Domain Routing (CIDR): an Address Assignment and Aggregation Strategy, RFC1519, IETF, Network Working Group, September 1993
- [22] Jon Postel (Editor), Internet Protocol - DARPA Internet Program - Protocol Specification, Information Sciences Institute, University of Southern California, RFC 791, September 1981
- [23] Clayton Christianson's The Innovator's Dilemma: When New Technologies Cause Great Firms to Fail, Harvard Business School Press, Boston, MA, USA, 1997, 225 pages, ISBN 0-87584-585-1
- [24] Carlos Cordeiro, Report on IEEE 802.22, IEEE J-SAC, and IEEE DySPAN 2007 tutorials, TCCN meeting at Globecom on November 27, 2006 [http://www.eecs.ucf.edu/tccn/meetings/Report\\_06.ppt](http://www.eecs.ucf.edu/tccn/meetings/Report_06.ppt)

# IK1550 Internetworking/Internetteknik

## Spring 2010, Period 4

### Module 2: IP Basics: Routing, ARP, and RARP

Lecture notes of G. Q. Maguire Jr.



KTH Information and  
Communication Technology

© 2010 G.Q.Maguire Jr. .

All rights reserved. No part of this course may be reproduced, stored in a retrieval system, or transmitted, in any form or by any means, electronic, mechanical, photocopying, recording, or otherwise, without written permission of the author.

Last modified: 2010.03.21:17:34

# IP Basics Outline

- IP Routing: Delivery and Routing of IP packets
- Address Resolution: ARP and RARP

# Connection-oriented vs Connectionless

- Connection-Oriented Services
  - Network layer first establishes a connection between a source and a destination
  - Packets are sent along this connection
  - Route is decided **once** at the time the connection is established
  - Routers/switches in connection-oriented networks are **stateful**
- Connectionless Services
  - Network layer can process each packet **independently**
  - A route lookup is performed for **each** packet
  - IP is connectionless
  - IP routers are **stateless**

Of course reality is (much) more complex, to gain performance IP routers dynamically create state (in caches) as there is frequently **correlation** between packets (i.e., if you just did a route lookup for destination B, there is a non-zero probability that another packet which will arrive shortly might also be headed to destination B).

# Routing

The internet protocols are based on moving packets from a source to a destination with each hop making a routing decision.

Two components to routing:

- **packet forwarding** - Routing Mechanism: search the routing table and decide which interface to send a packet out.
  - A matching host address? If no,
  - A matching network address? (using longest match) If no,
  - Default entry.
- **computing routes** - Routing Policy: rules that decide which routes should be added into the routing table.

Traditionally most of the complexity was in the later (i.e., computing routes) while packet forwarding was very straight forward -- this is no longer true due to QoS.

Routers vs. hosts -- a node can be both

- Routers forward IP packets
- Hosts generate or sink IP packets

# Direct vs. indirect Delivery

- **Direct delivery**

- The final destination is (directly) connected to the same physical network as the sender
- IP destination address and local interface have the same netmask
- Map destination IP address to destination physical address via **ARP**

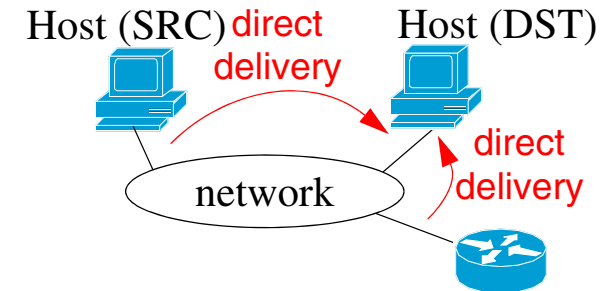

- **Indirect delivery**

- From router to router (note: the last delivery is always direct!)
- Destination address is used for a **routing lookup** in a **routing table**: Routing

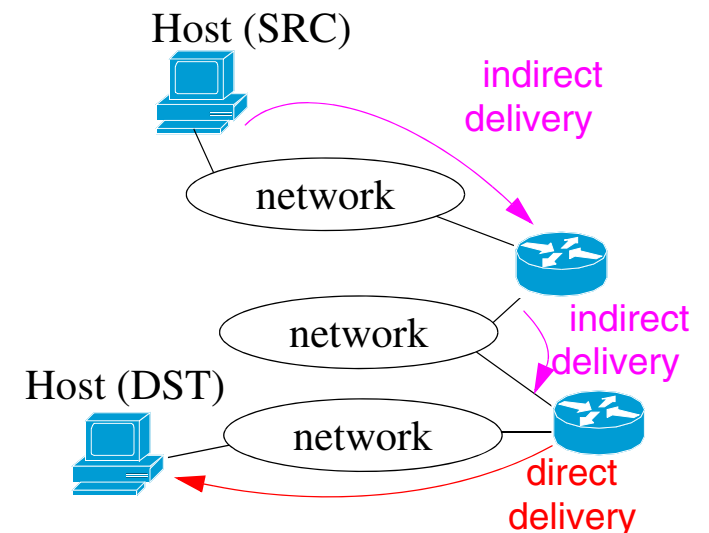

SRC=Source  
DST = Destination



# Forwarding

- Next-Hop method - routing table holds only the address of the next hop

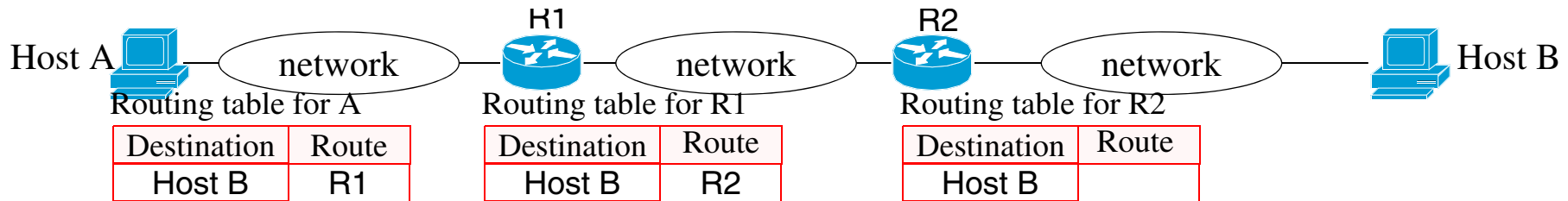

- Network-specific method - routing table entries are for **networks**

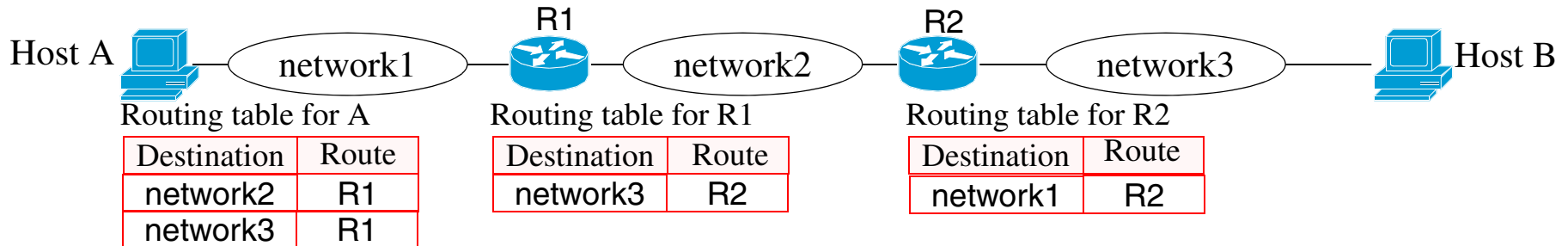

- Host-specific method - per host routes
- Default method - specifies a default route (normally network address 0.0.0.0)

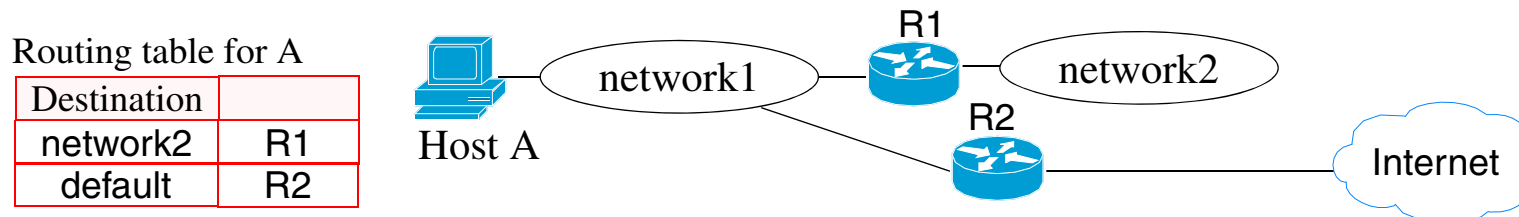

See textbook sections 6.2 for more examples.

# Processing

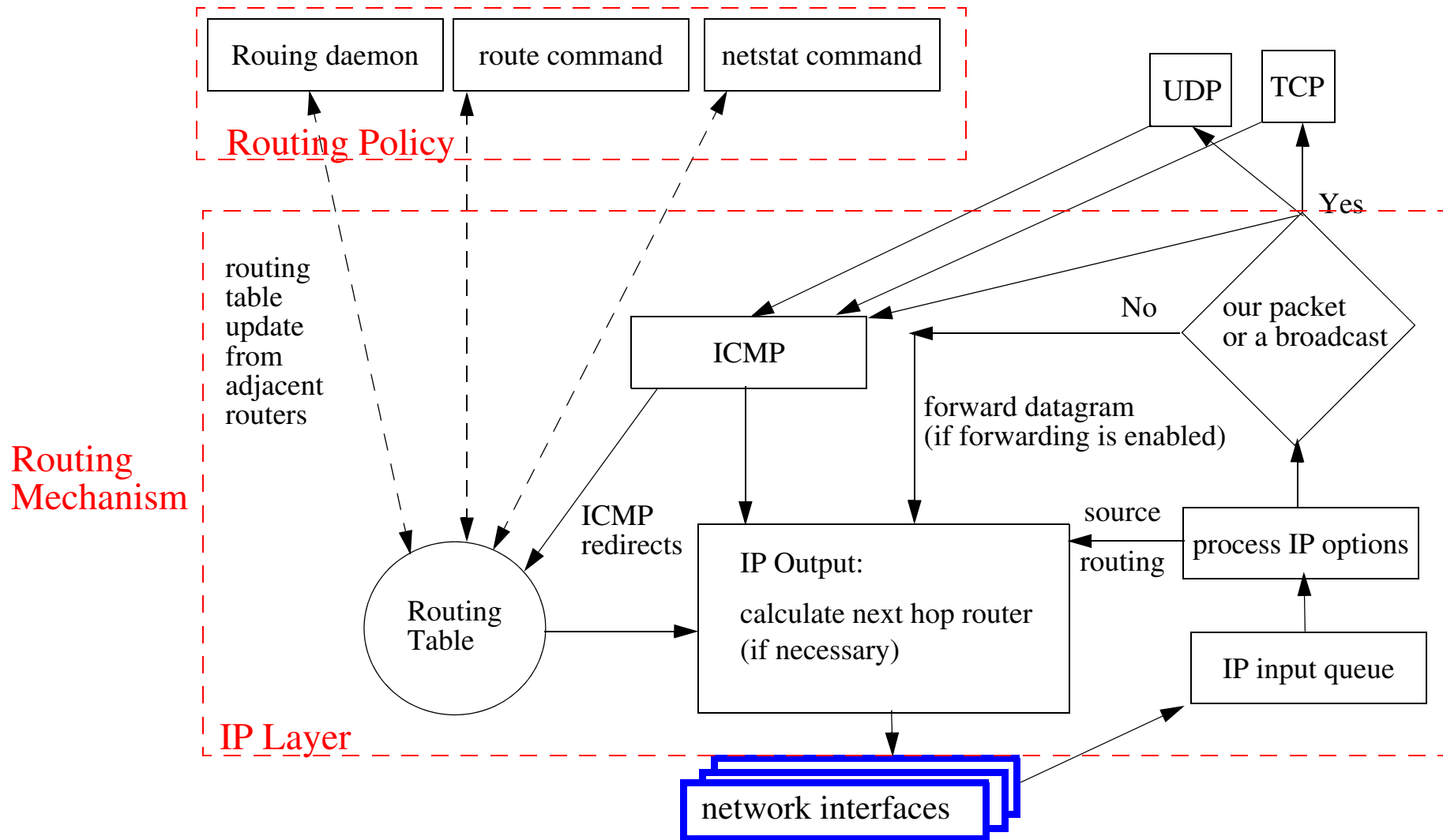

# Forwarding module

A simplified view of forwarding using classful address without subnetting:

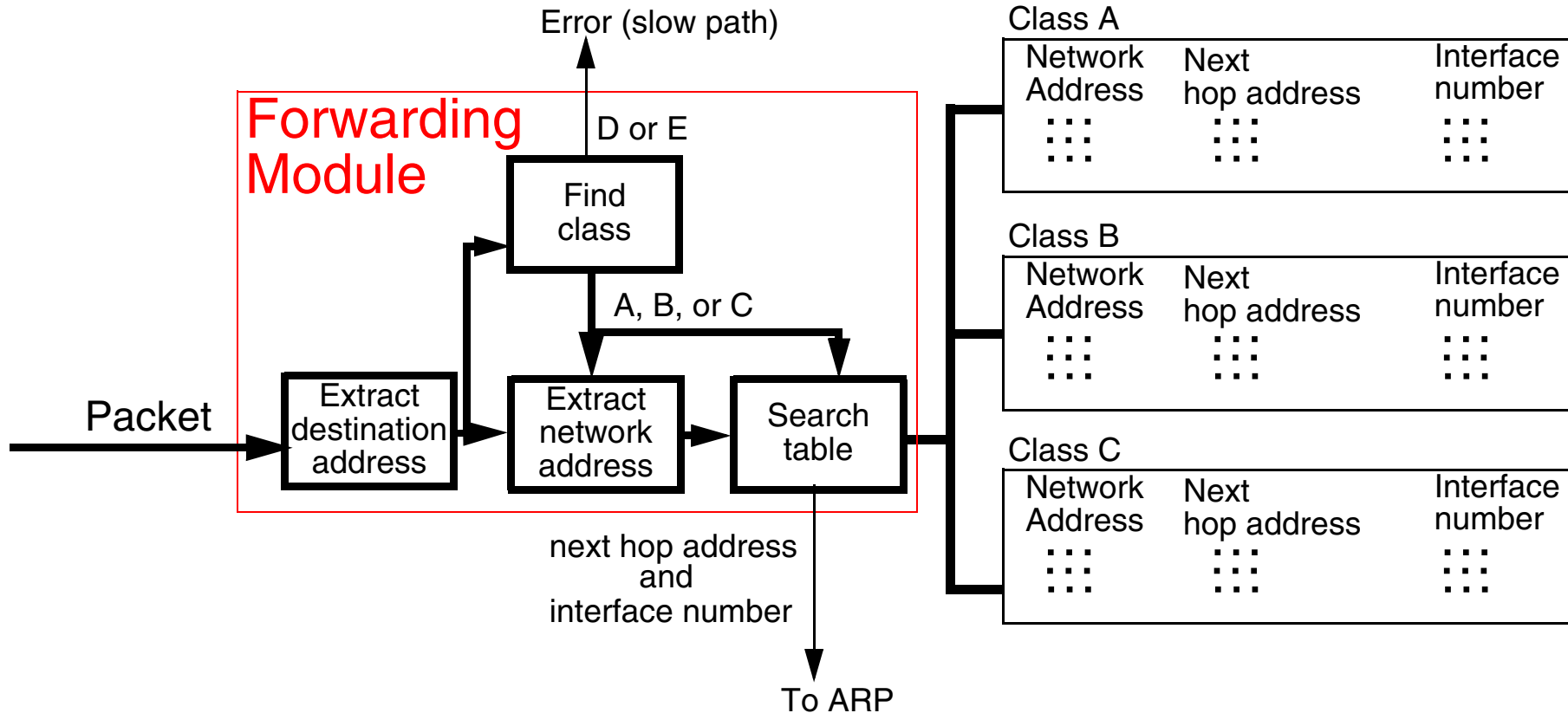

The bulk of the forwarding effort is **searching** the tables (as most of the rest of the processing is simple logical bit operations).

# Routing Table Search - Classless

- Match destination with longest prefixes first
  - Software algorithms: tree, binary trees, tries (different data structures) [6]
  - Hardware support: Content Addressable Memory (CAM)
    - Ternary CAM (TCAM) - [1],[2] - for searching and pattern matching
    - Ternary because each cell has three states: 0, 1, or ? (aka "don't care")
    - Performance an associate search (i.e., in parallel), returns the index (X) of the first match
    - 4-8 ns/search (i.e., 125M - 250M lookups per second)

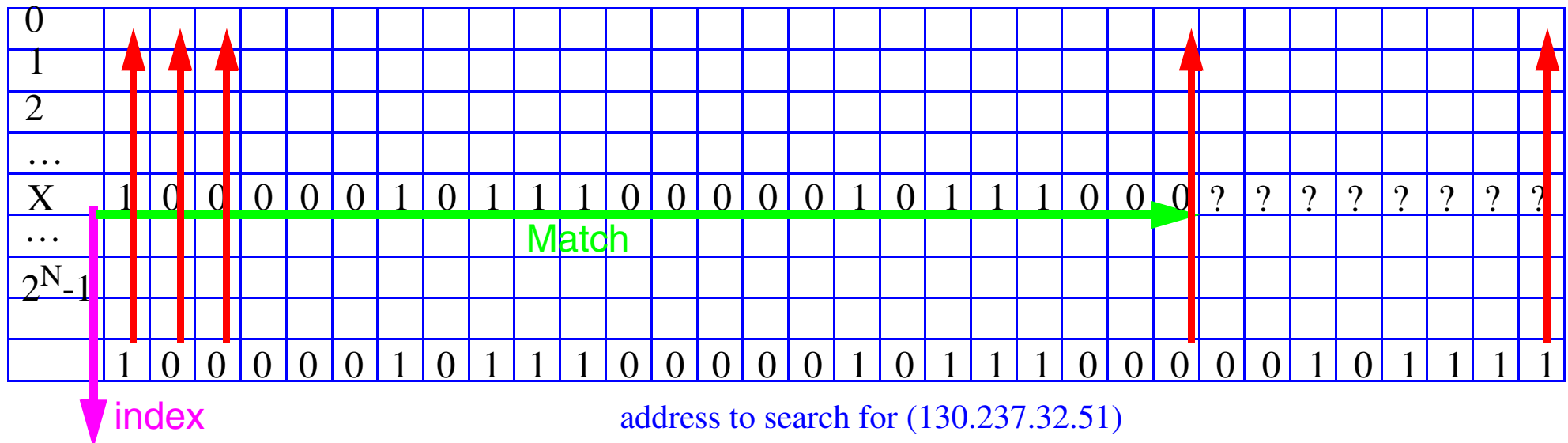

Note that the entries in the table have to be sorted - to achieve the longest match being at the smallest index.

# Fast forwarding

Mikael Degermark, Andrej Brodnik, Svante Carlsson, Stephen Pink,  
“Small Forwarding Tables for Fast Routing Lookups”,  
in Proceedings of the ACM SIGCOMM’97. (*compressed postscript*) {basis for *Effnet AB*}

- IP routing lookups must find routing entry with longest matching prefix.

Networking community *assumed* it was impossible to do IP routing lookups in software fast enough to support gigabit speeds - but they were wrong!

Paper presents a forwarding table data struct. designed for quick routing lookups.

- Such forwarding tables are small enough to fit in the cache of a conventional general purpose processor.
- The forwarding tables are very small, a large routing table with 40,000 routing entries can be compacted to a forwarding table of 150-160 Kbytes.
- With the table in cache, a 200 MHz Pentium Pro or 333 MHz Alpha 21164 can perform >2 million lookups per second.
  - A lookup typically requires less than 100 instructions on an Alpha, using eight memory references accessing a total of 14 bytes.

∴ Full routing lookup of each IP packet at gigabit speeds without special hardware

# Routing Tables

- Aggregate IP addresses (i.e., exploit CIDR)
  - more specific networks (with longer prefixes)
  - less specific networks (with shorter prefixes)
  - $\Rightarrow$  smaller routing tables
- If each routing domain exports (i.e., tells others) only a small set of prefixes, this makes it easier for other routers to send traffic to it
  - Unfortunately this requires clever address assignments
- Some mechanisms lead to increased fragmentation
  - Due to limited availability of addresses long prefixes (particularly /24) are scattered geographically
  - Increasingly sites are connected to multiple ISPs (for redundancy) i.e., Multihoming - thus they have addresses from several **different** subnetworks
- Current routing tables have ~157,975 entries [7] (of which a large fraction are /24 prefixes) with a growth rate of “18,000 entries per year”[8].

There are a limited number of prefixes for Class A + B + C networks (2,113,664). If the longest prefixes which a backbone router had to deal with were /24, then a table with 16,777,216 entries would be sufficient (even without aggregation) - each entry only needs to store the outgoing port number! This would allow a **direct lookup** in a memory of ~26Mbytes - with upto 256 outgoing ports.

# Routing table

| Flags | Destination IP address | Next-hop Router IP address | point to local interface to use | Refcnt     | Use        | PMTU ...   |
|-------|------------------------|----------------------------|---------------------------------|------------|------------|------------|
| UGH   | 140.252.13.65          | 140.252.13.35              | emd0                            | <i>ddd</i> | <i>ddd</i> | <i>ddd</i> |
| U     | 140.252.13.32          | 140.252.13.34              | emd0                            | <i>ddd</i> | <i>ddd</i> | <i>ddd</i> |
| UG    | default                | 140.252.13.33              | emd0                            |            |            |            |
| UH    | 127.0.0.1              | 127.0.0.1                  | lo0                             |            |            |            |

where *ddd* is some numeric value.

display the routing table with "netstat -rn"

"r" is for routing table

"n" asks for numeric IP addresses rather than name

## Flags:

|   |                                    |
|---|------------------------------------|
| U | route is Up                        |
| G | route is to a Gateway              |
| H | route is to a Host                 |
| D | route was Discovered by a redirect |
| M | route was Modified by a redirect   |

# Host vs. router - two behaviors

- Hosts generate or sink IP packets
- Routers forward IP packets

Thus it is possible for a device to be both a host **and** a router.

**Unless** a host is **explicitly** configured as a router is **not** supposed to forward IP datagrams. The default behavior must be **never forward**.

In linux the variable which controls this is: `/proc/sys/net/ipv4/ip_forward`

- If this variable is set to **1**, then the node **will** perform IP forwarding.
- If this variable is set to **0**, then the node **will not** perform IP forwarding.



# Host routing

A host either:

- knows a route - manually **configured** [i.e., "Static routes"]
  - from the interface (for directly connected networks) or manually via the "route" command
- or **learns of a route** [i.e., "Dynamic routes"]
  - Simplest method of learning a route:
    - The host sends a packet via the default route and is told via an ICMP Redirect of a better route
  - or the host hears an ICMP router advertisement (perhaps in response to its ICMP router solicitation message)
    - routers (**almost**) periodically broadcast or multicast advertisements of their existence and desire to provide routing service
    - format of ICMP router advertisement packet shown in Forouzan figure 9.18 on page 226
    - advertisements typically every 450..600 seconds
    - advertisements have a stated lifetime (typically 30 minutes)
  - or the host learns via a dynamic routing protocol.
- or uses a **default** route.

On booting hosts send ~3 ICMP router solicitation messages (~3 seconds apart) to find a default router. This allows for dynamic discovery of the default router.

# Routing

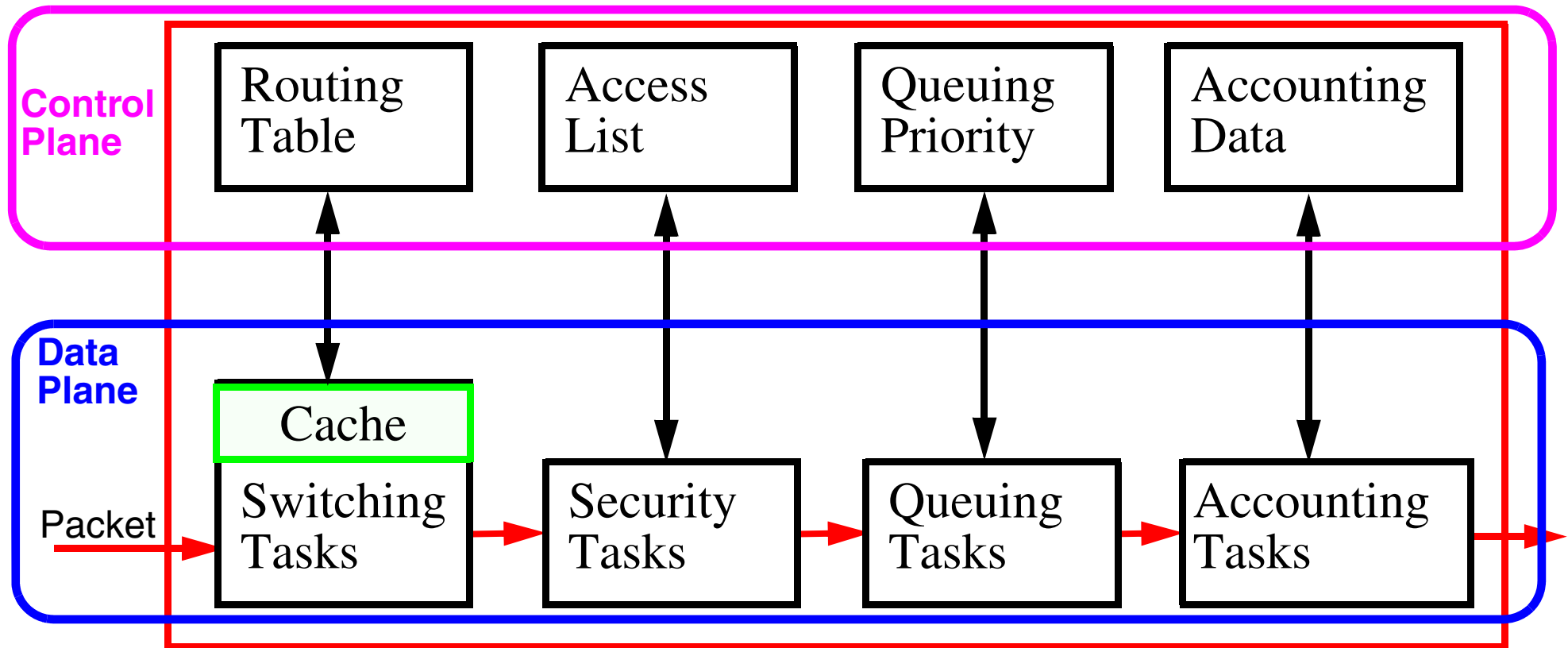

Figure 1: Basic steps in Routing

The routing table tells us which output port to use based on the destination (and possibly the source) IP address. The **data plane** has to run at packet rates (i.e., in real-time). However, a router also performs a lot of other processing

# Combining layers

Many devices now combine processing of several layers:

- Switch/Routers: combine layers 2+3

Devices combining layers 3+4 are appearing - which extract “flows” based on looking at transport layer port numbers in addition to network addresses.

# ARP and RARP

Address resolution (logical  $\Leftrightarrow$  physical addresses):

- Mapping IP addresses  $\Rightarrow$  link layer (MAC) addresses via [Address Resolution Protocol \(ARP\)](#)
- Mapping link layer (MAC) addresses  $\Rightarrow$  IP addresses via [Reverse Address Resolution Protocol \(RARP\)](#)

# What to do with a new computer?

We will assume that the computer has an ethernet interface:

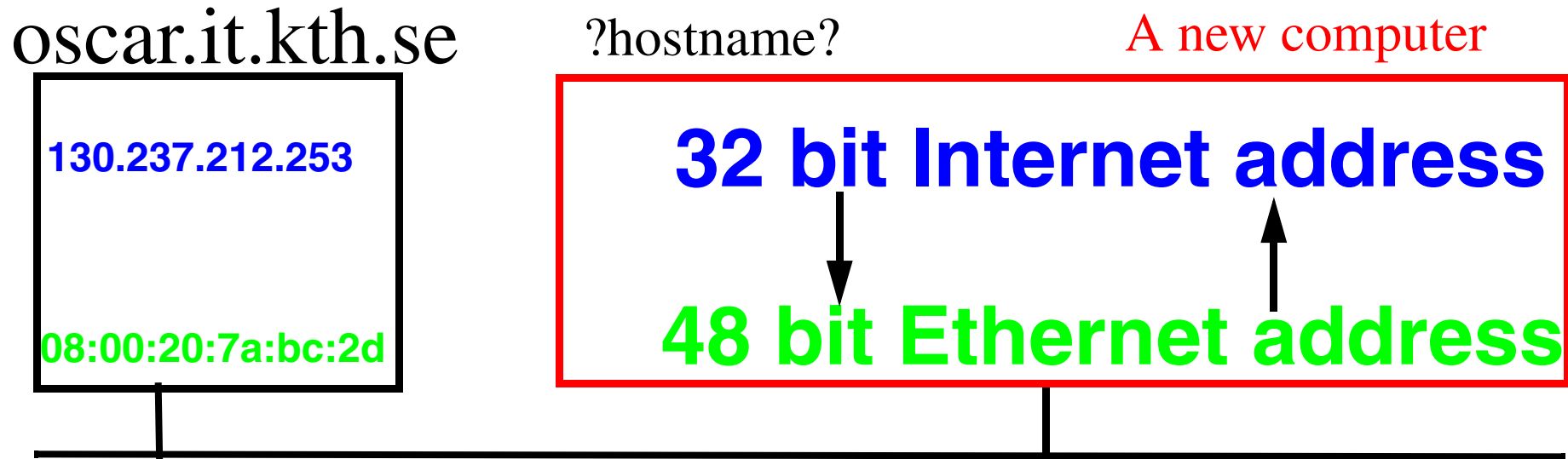

Figure 2: Name and IP Address needed!

- **Direct mapping** - requires no I/O, just a computation; hard to maintain; and requires stable storage (since you have to store the mappings somewhere) *or*
- **Dynamic Binding** - easier to maintain; but has a delay while messages are exchanged

# Address Resolution: ARP, RARP

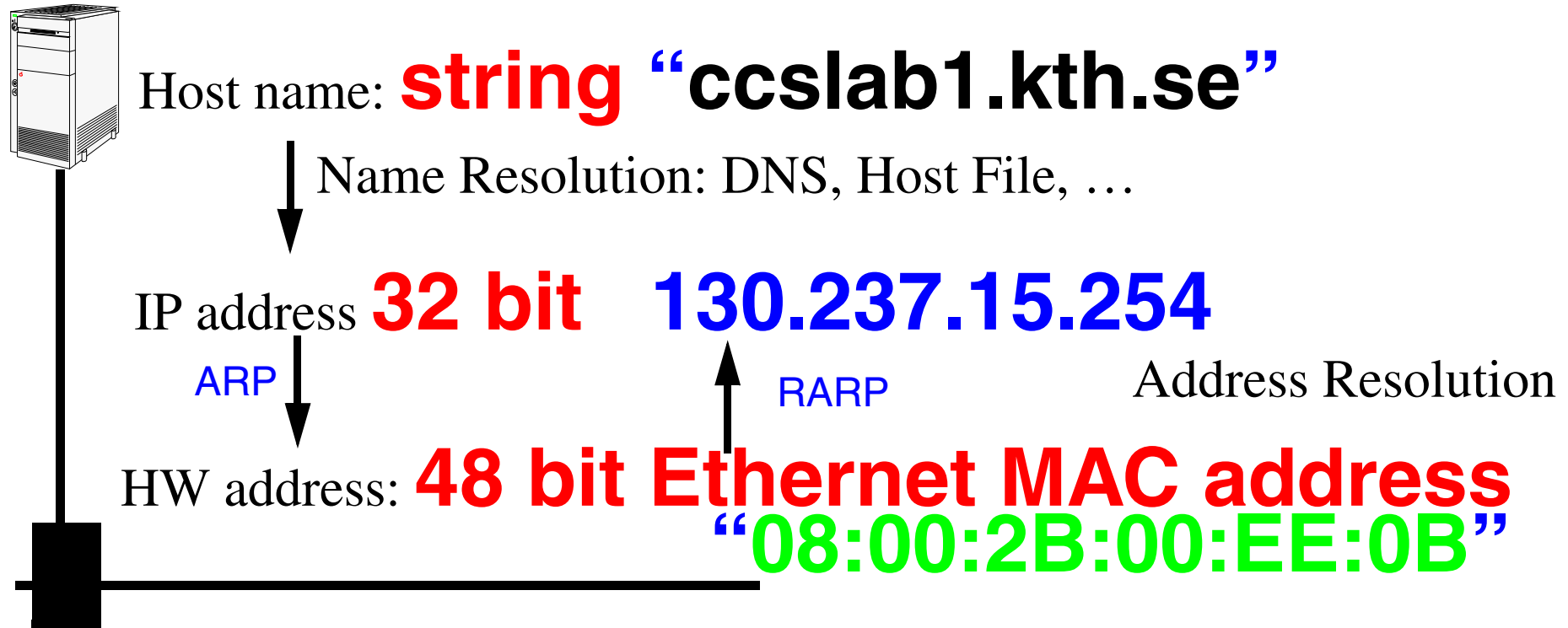

Figure 3: mapping between host names, IP address, and MAC address

ARP - Address Resolution Protocol

RARP- Reverse ARP

# ARP ≡ Address Resolution Protocol (RFC826)

Address Resolution Protocol (ARP) - allows a host to find the physical address of a target host **on the same network**, given only the target's internet address.

- Sending host (source) wants to send an IP datagram, but does not know the corresponding ethernet address
- ARP request - **broadcast** to every host on the network (i.e., EtherDST=0xFFFFFFFFFFFFFFF), TYPE=0x0806
- Destination host: "It is my address!" and sends an ARP reply
- Source host - receives the **unicast** ARP reply, and now uses it to send the IP datagram

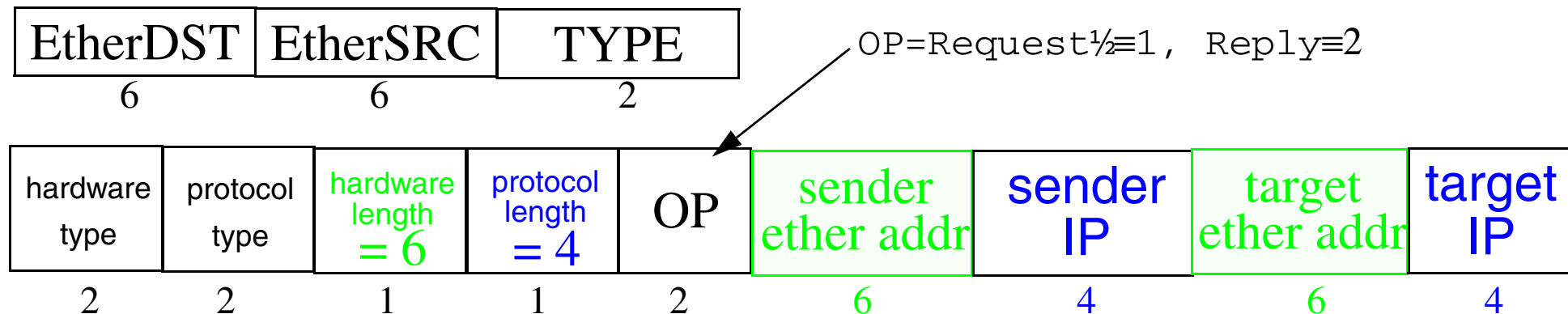

Figure 4: Format of ARP request/reply packet (see Stevens, Vol. 1, figure 4.3, pg. 56)

# ARP example 1

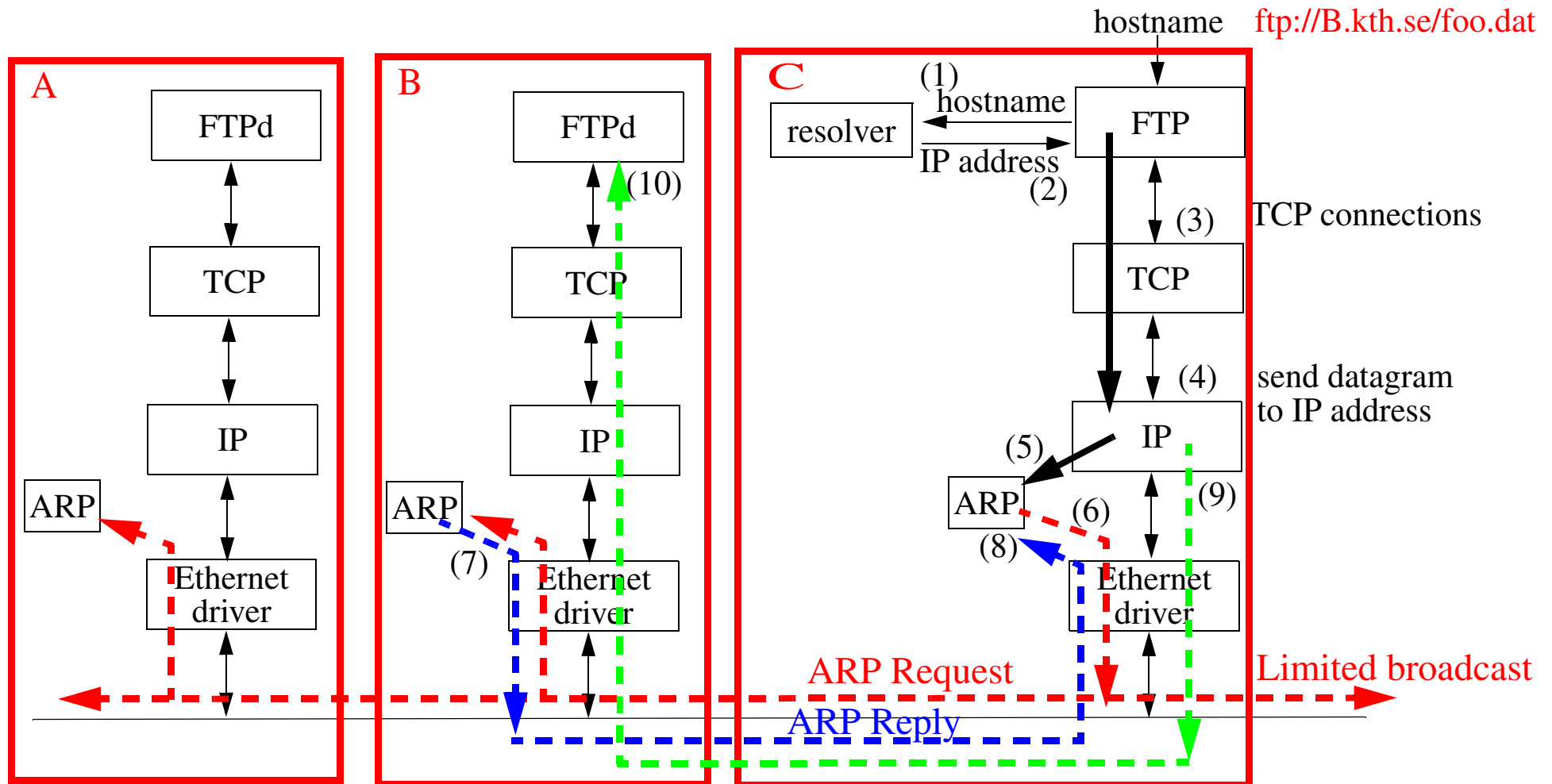

Figure 5: Using ARP on host C to determine MAC address of the interface on host B



# Address Resolution Cache

Since you have just looked up the address, save (*cache*) it for reuse:

- to limit ARP traffic
- works because of *correlations* in use of addresses

You can examine the arp cache:

```
arp -a
machine-name (x.x.x.x) at xx:xx:xx:xx:xx:xx
...
```

```
arp -an
(x.x.x.x) at xx:xx:xx:xx:xx:xx
...
```

Note that the later form (with the “n” option) does *not* lookup the hostname, this is *very useful* when you don’t yet have a name resolution service working!

## ARP Refinements

Since the sender’s Internet-to-Physical address binding is in every ARP broadcast; (all) receivers update their caches before processing an ARP packet

# ARP Timeouts

- If there is no reply to an ARP request
  - the machine is down or not responding
  - request was lost, then retry (but not too often)
  - eventually give up (When?)
- ARP cache timeouts
  - Berkeley implementations timeout
    - completed entry in 20 minutes
    - incomplete entry in 3 minutes
  - Linux:
    - for entries to which there has been no traffic a timeout occurs at `gc_stale_time`, set to 60 seconds by default (`/proc/sys/net/ipv4/neigh/default/gc_stale_time`)
  - Microsoft Windows NT and XP
    - Using the registry editor, see `HKEY_LOCAL_MACHINE\SYSTEM\CurrentControlSet\Services\Tcpip\Parameters` enter `ArpCacheLife` {see [http://www.psc.edu/networking/projects/tcptune/OStune/winxp/winxp\\_stepbystep.html](http://www.psc.edu/networking/projects/tcptune/OStune/winxp/winxp_stepbystep.html) } default value is set to 2 minutes
  - Cisco IOS v10.0 and above
    - select interface then “arp timeout xxxx”, default value is set to 240 minutes (14400 sec.) and can be changed on a per-interface basis
  - RFC 1533: DHCP Options and BOOTP Vendor Extensions, defines:
    - ARP Cache Timeout Option (code for this option is 35).
  - Host Requirements RFC - says entries should be timed out **even if in use**

# ARP example 2

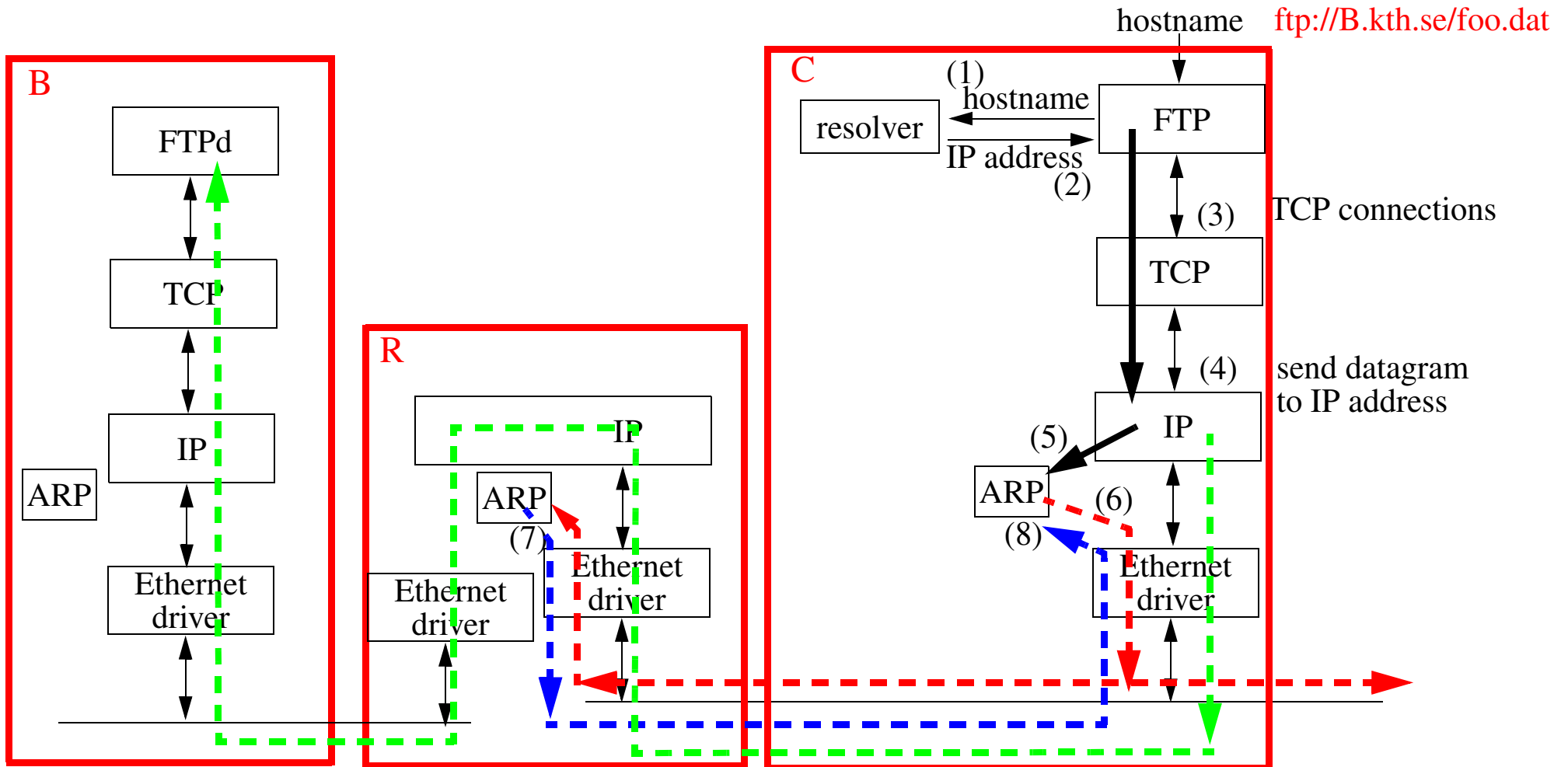

Figure 6: Router (R) doing a Proxy ARP to provide MAC address of B

# Proxy ARP (RFC 826)

Lets a **router** on the network answer for a host which is NOT necessarily on the local network segment.

But how does this router know?

- It can make an ARP request itself or
- Perhaps it already knows - because it has an entry in it's ARP cache

For an example of using proxy arp with subnetting see:

- <http://www.linuxdoc.org/HOWTO/mini/Proxy-ARP-Subnet/why.html> and
- <http://www.linuxdoc.org/HOWTO/mini/Proxy-ARP-Subnet/how.html>

# Gratuitous ARP

Host sends a request for its own address

- generally done at boot time to inform other machines of its address (possibly a new address) - gives these other hosts a chance to update their cache entries immediately
- lets hosts check to see if there is another machine claiming the same address ⇒  
“duplicate IP address sent from Ethernet address a:b:c:d:e:f”

As noted before, hosts have paid the price by servicing the broadcast, so they can cache this information - this is one of the ways the proxy ARP server could know the mapping.

Note that **faking** that you are another machine can be used to provide **failover** for servers (see for example heartbeat, fake, etc. at <http://www.linux-ha.org/download/> for a send\_arp program). [It can also be used very various **attacks!**]

# Additional ARP commands

- **publish** entries (i.e., mechanically make an entry and answer replies)

Publishing entries is one way that (embedded) devices can learn their IP address.

```
# arp -s birkexample 08:00:2B:00:EE:0B pub
# arp -an
(192.168.1.1) at 0:4:5a:de:e8:f9 ether
...
(172.16.32.20) at 8:0:2b:0:ee:b ether permanent published
```

where `birkexample` has the IP address: `172.16.32.20`

- explicitly **delete** entries

```
# arp -d birkexample
birkexample (172.16.32.20) deleted
# arp -an
(192.168.1.1) at 0:4:5a:de:e8:f9 ether
```

# ARP - as seen with ethereal

| Time     | Source      | Destination | Protocol | Info                                  |
|----------|-------------|-------------|----------|---------------------------------------|
| 1.995245 | 172.16.33.3 | Broadcast   | ARP      | Who has 172.16.33.2? Tell 172.16.33.3 |

Frame 2 (60 bytes on wire, 60 bytes captured)

Arrival Time: Mar 23, 2005 11:32:45.184792000

Time delta from previous packet: 1.995245000 seconds

Time since reference or first frame: 1.995245000 seconds

IEEE 802.3 Ethernet

Destination: ff:ff:ff:ff:ff:ff (Broadcast)

Source: 00:40:8c:30:d4:32 (172.16.33.3)

Length: 36

Trailer: 00000000000000000000

Type: [ARP \(0x0806\)](#)

Address Resolution Protocol (request)

Hardware type: IEEE 802 (0x0006)

Protocol type: IP (0x0800)

Hardware size: 6

Protocol size: 4 Opcode: request (0x0001)

Sender MAC address: 00:40:8c:30:d4:32 (172.16.33.3)

Sender IP address: 172.16.33.3 (172.16.33.3)

Target MAC address: ff:ff:ff:ff:ff:ff (Broadcast)

Target IP address: 172.16.33.2 (172.16.33.2)

```
0000  ff ff ff ff ff ff 00 40 8c 30 d4 32 00 24 aa aa  .....@.0.2.$..
0010  03 00 00 00 08 06 00 06 08 00 06 04 00 01 00 40  .....@
0020  8c 30 d4 32 ac 10 21 03 ff ff ff ff ff ff ac 10  .0.2..!..... <<< unlike what page 163 says it is not all zeros!
0030  21 02 00 00 00 00 00 00 00 00 00 00 00 00 00 00  !.....
```

# non ARP example 1

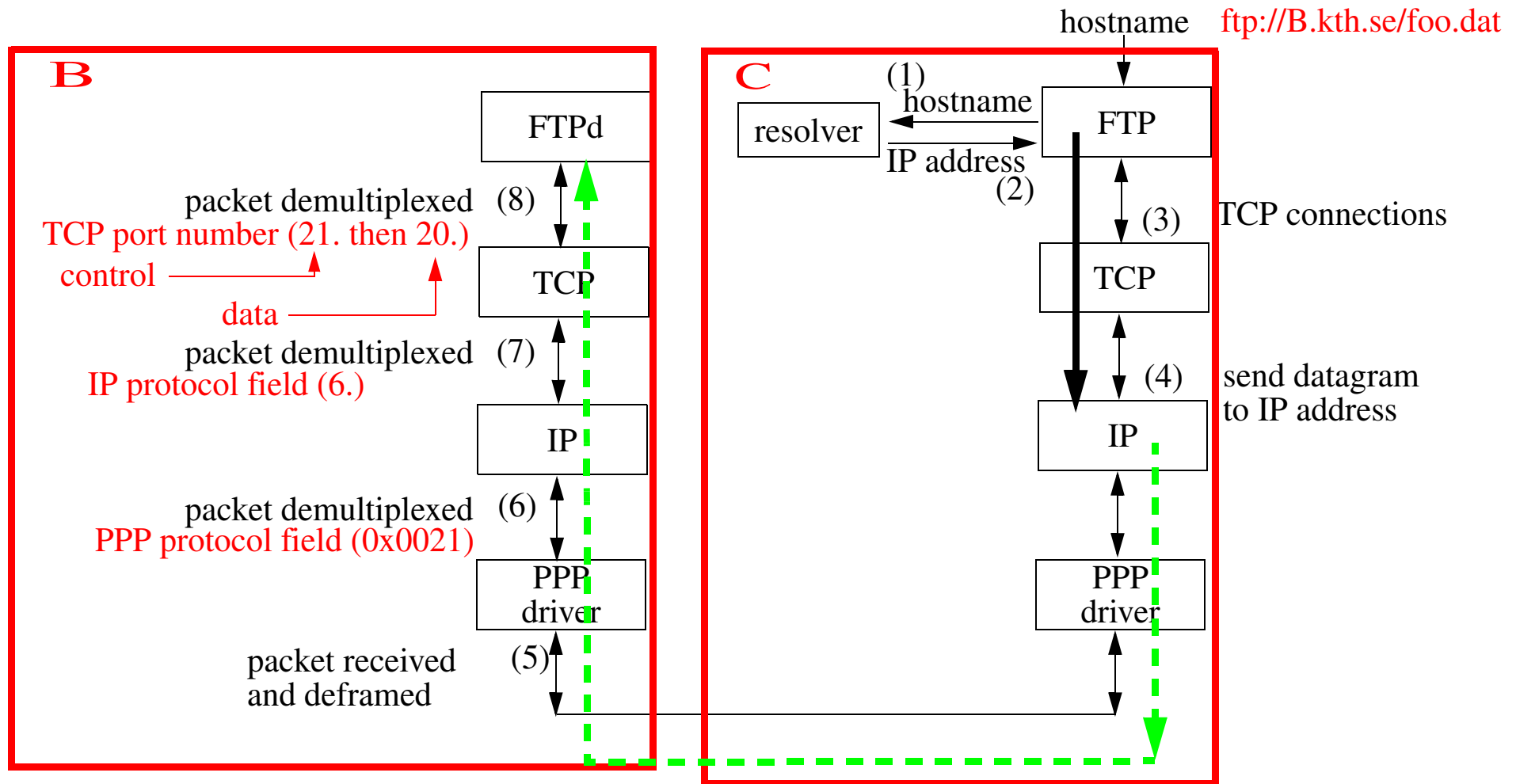

Figure 7: On a point-to-point link there is no need for ARP (figure also shows explicitly the demultiplexing)

Note that the PPP protocol field plays a role similar to the ethernet [frame type](#).



# RARP: Reverse Address Resolution Protocol (RFC 903)

How do you get you own IP address, when all you know is your link address?

- Necessary if you don't have a disk or other stable store
- RARP request - broadcast to every host on the network (i.e., EtherDST=0xFFFFFFFFFFFFFFF), TYPE=0x8035
- RARP server: "I know that address!" and sends an RARP reply
- Source host - receives the RARP reply, and now knows its own IP addr

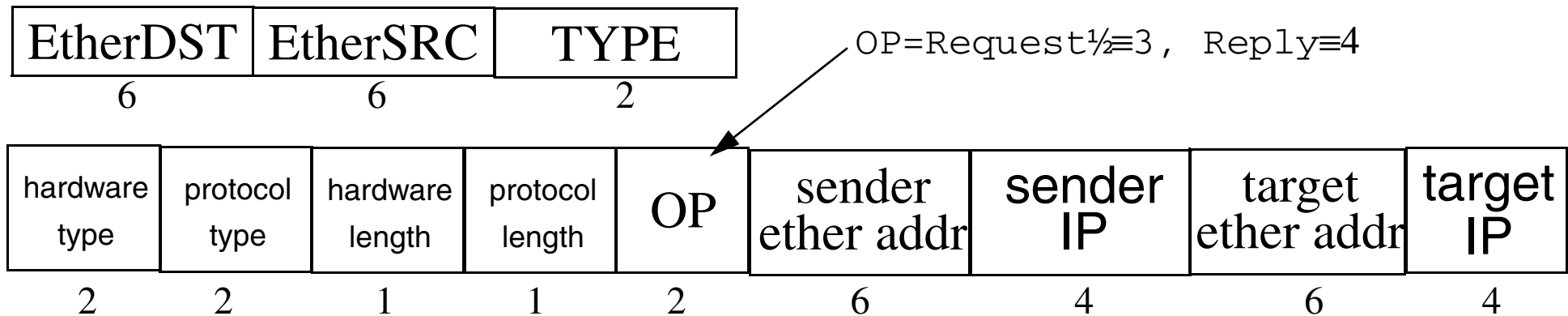

Figure 8: Format of RARP request/reply packet

Note: You can now see what the "publish" aspect of the `arp` command is for.

# RARP - as seen with ethereal

| Time     | Source      | Destination | Protocol | Info   |
|----------|-------------|-------------|----------|--|
| 0.000000 | 172.16.33.3 | Broadcast   | RARP     | Who is 00:40:8c:30:d4:32? Tell 00:40:8c:30:d4:32 |

Frame 1 (60 bytes on wire, 60 bytes captured)  
Arrival Time: Mar 23, 2005 11:32:43.189547000  
Time delta from previous packet: 0.000000000 seconds  
Time since reference or first frame: 0.000000000 seconds

Ethernet II, Src: 00:40:8c:30:d4:32, Dst: ff:ff:ff:ff:ff:ff  
Destination: ff:ff:ff:ff:ff:ff (Broadcast)  
Source: 00:40:8c:30:d4:32 (172.16.33.3)  
Type: **RARP (0x8035)**

Trailer: 00000000000000000000000000000000...

Address Resolution Protocol (reverse request)  
Hardware type: Ethernet (0x0001)  
Protocol type: IP (0x0800)  
Hardware size: 6  
Protocol size: 4  
Opcode: reverse request (0x0003)  
Sender MAC address: 00:40:8c:30:d4:32 (172.16.33.3)  
Sender IP address: 0.0.0.0 (0.0.0.0)  
Target MAC address: 00:40:8c:30:d4:32 (172.16.33.3)  
Target IP address: 0.0.0.0 (0.0.0.0)

```
0000  ff ff ff ff ff ff 00 40 8c 30 d4 32 80 35 00 01  .....@.0.2.5..
0010  08 00 06 04 00 03 00 40 8c 30 d4 32 00 00 00 00  .....@.0.2.... <<< as the source does not know its own IP address
0020  00 40 8c 30 d4 32 00 00 00 00 00 00 00 00 00 00  .@.0.2..... <<< as the source does not know the target's IP address
0030  00 00 00 00 00 00 00 00 00 00 00 00 00 00 00 00  .....
```

# RARP server

Someone has to know the mappings - quite often this is in a file “/etc/ethers”

Since this information is generally in a file, RARP servers are generally implemented as **user processes** (because a kernel process should **not** do file I/O!)

- Unlike ARP responses which are generally part of the TCP/IP implementation (often part of the kernel).
- How does the process get the packets - since they aren't IP and won't come across a socket?
  - BSD Packet filters
  - SVR4 Data Link Provider Interface (DLPI)
  - SUN's Network Interface Tap (NIT)
  - Interestingly in the appendix to RFC 903 an alternative to having data link level access was to have two IOCTLS, one that would "sleep until there is a translation to be done, then pass the request out to the user process"; the other means: "enter this translation into the kernel table"
- RARP requests are sent as hardware level broadcasts - therefore are **not** forwarded across routers:
  - multiple servers per segment - so in case one is down; the first response is used
  - having the router answer

# Alternatives to RARP

In a later lecture we will examine:

- BOOTP and DHCP (for both IPv4 and IPv6) and
- autoconfiguration for IPv6.

# Novel IPX/SPX Addresses

Another approach to [network addresses](#) - which are tied to the MAC address

IPX/SPX == INternetwork Packet Exchange/Sequenced Packet Exchange

IPX address: 32 bits of network ID and 48 bits of host ID (the ethernet address)

Problems:

- There is no central authority for allocating the network IDs
  - ✗ So if you interconnect multiple IPX networks you may have to renumber every network
- If you change ethernet cards, you get a new address!
- Assumes that all machines are attached to a high capacity LAN.

Advantages

- You only have to assign network numbers, then the hosts figure out their own address. Simpler administration.

Novell NetWare provides: Service Advertising Protocol (SAP), Routing Information Protocol (RIP), and NetWare Core Protocol (NCP).

# Useful tools

For looking at and generating packets!

# tcpdump

## Under HP-UX 11.0

```
# ./tcpdump -i /dev/dlpi0
tcpdump: listening on /dev/dlpi0
22:25:43.217866 birk2.5900 > nucmed35.50251: . ack 3089200293 win 8080 (DF)
22:25:43.290636 birk2.5900 > nucmed35.50251: P 0:4(4) ack 1 win 8080 (DF)
22:25:43.360064 nucmed35.50251 > birk2.5900: . ack 4 win 32768
22:25:43.363786 birk2.5900 > nucmed35.50251: P 4:167(163) ack 1 win 8080 (DF)
22:25:43.364159 nucmed35.50251 > birk2.5900: P 1:11(10) ack 167 win 32768
22:25:43.543867 birk2.5900 > nucmed35.50251: . ack 11 win 8070 (DF)
22:25:43.577483 birk2.5900 > nucmed35.50251: P 167:171(4) ack 11 win 8070 (DF)
22:25:43.640052 nucmed35.50251 > birk2.5900: . ack 171 win 32768
22:25:43.643793 birk2.5900 > nucmed35.50251: P 171:334(163) ack 11 win 8070 (DF)
22:25:43.644132 nucmed35.50251 > birk2.5900: P 11:21(10) ack 334 win 32768
22:25:43.750062 birk2.5900 > nucmed35.50251: . ack 21 win 8060 (DF)
22:25:43.873349 birk2.5900 > nucmed35.50251: P 334:338(4) ack 21 win 8060 (DF)
22:25:43.940073 nucmed35.50251 > birk2.5900: . ack 338 win 32768
13 packets received by filter
0 packets dropped by kernel
```

# tcpdump - Linux

```
nucmed30:/home/maguire # /usr/sbin/tcpdump -i eth1
```

```
tcpdump: verbose output suppressed, use -v or -vv for full protocol decode  
listening on eth1, link-type EN10MB (Ethernet), capture size 96 bytes
```

```
14:21:52.736671 IP nucmed30.local.domain.must-p2p > jackb.ssh: P 1818006646:1818006726(80) ack 307068981 win 591>  
14:21:52.737291 IP jackb.ssh > nucmed30.local.domain.must-p2p: P 1:113(112) ack 80 win 32768 <nop,nop,timestamp >  
14:21:52.737917 IP nucmed30.local.domain.must-p2p > jackb.ssh: P 80:160(80) ack 113 win 5910 <nop,nop,timestamp >  
14:21:52.802719 IP jackb.ssh > nucmed30.local.domain.must-p2p: . ack 160 win 32768 <nop,nop,timestamp 25983516 2>
```

...

```
14:21:57.782196 arp who-has jackscan tell nucmed30.local.domain  
14:21:57.784218 arp reply jackscan is-at 00:40:8c:30:d4:32  
14:21:57.784253 IP nucmed30.local.domain > jackscan: icmp 64: echo request seq 1  
14:21:57.784971 IP jackscan > nucmed30.local.domain: icmp 64: echo reply seq 1  
14:21:58.782187 IP nucmed30.local.domain > jackscan: icmp 64: echo request seq 2  
14:21:58.782912 IP jackscan > nucmed30.local.domain: icmp 64: echo reply seq 2  
14:21:59.783036 IP nucmed30.local.domain > jackscan: icmp 64: echo request seq 3  
14:21:59.783759 IP jackscan > nucmed30.local.domain: icmp 64: echo reply seq 3
```

...

```
14:21:59.802600 IP jackb.ssh > nucmed30.local.domain.must-p2p: . ack 2864 win 32768 <nop,nop,timestamp 25984216 >  
14:22:00.739485 IP nucmed30.local.domain.must-p2p > jackb.ssh: P 2864:2944(80) ack 897 win 5910 <nop,nop,timesta>
```

```
84 packets captured  
84 packets received by filter  
0 packets dropped by kernel
```



# Tools Used: tcpdump Program

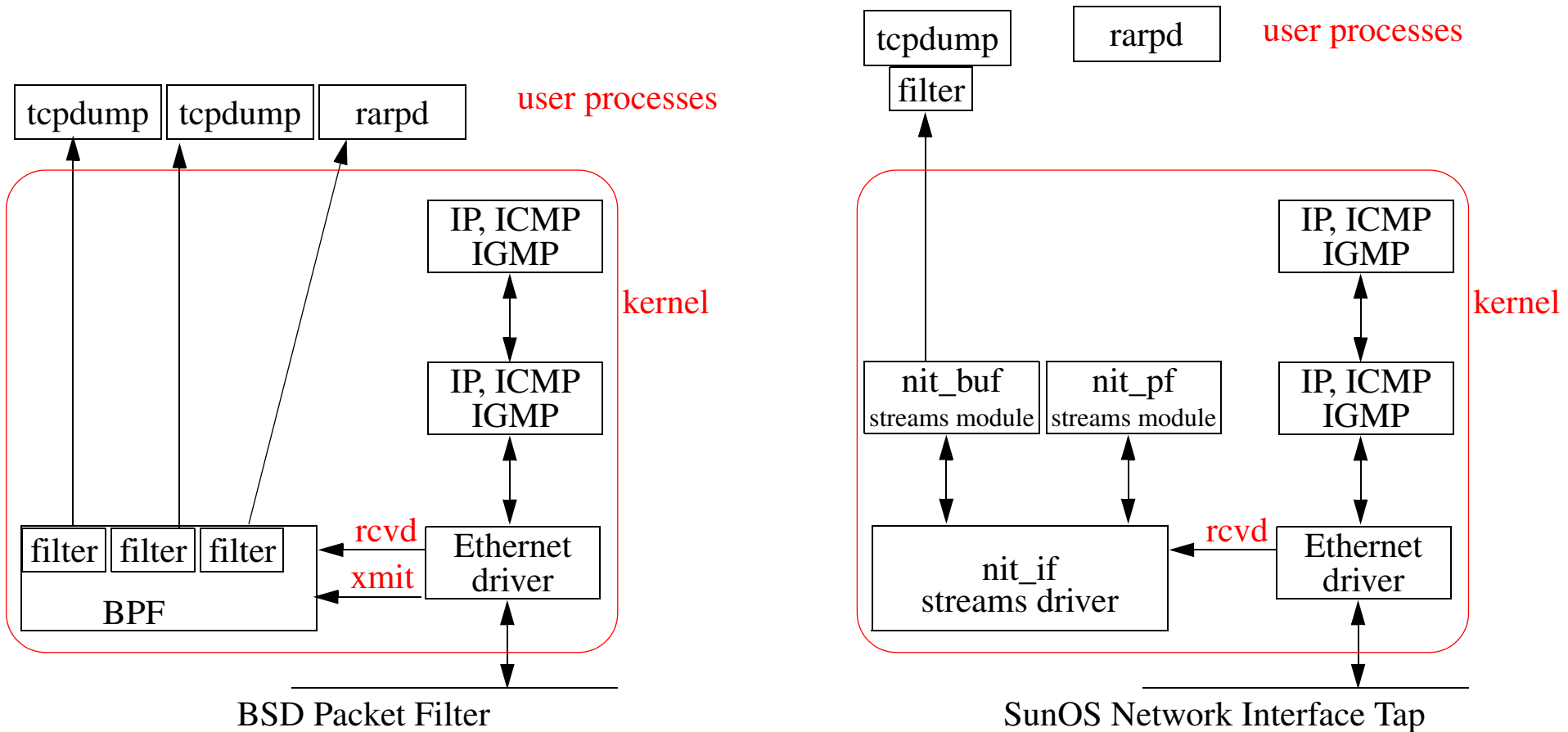
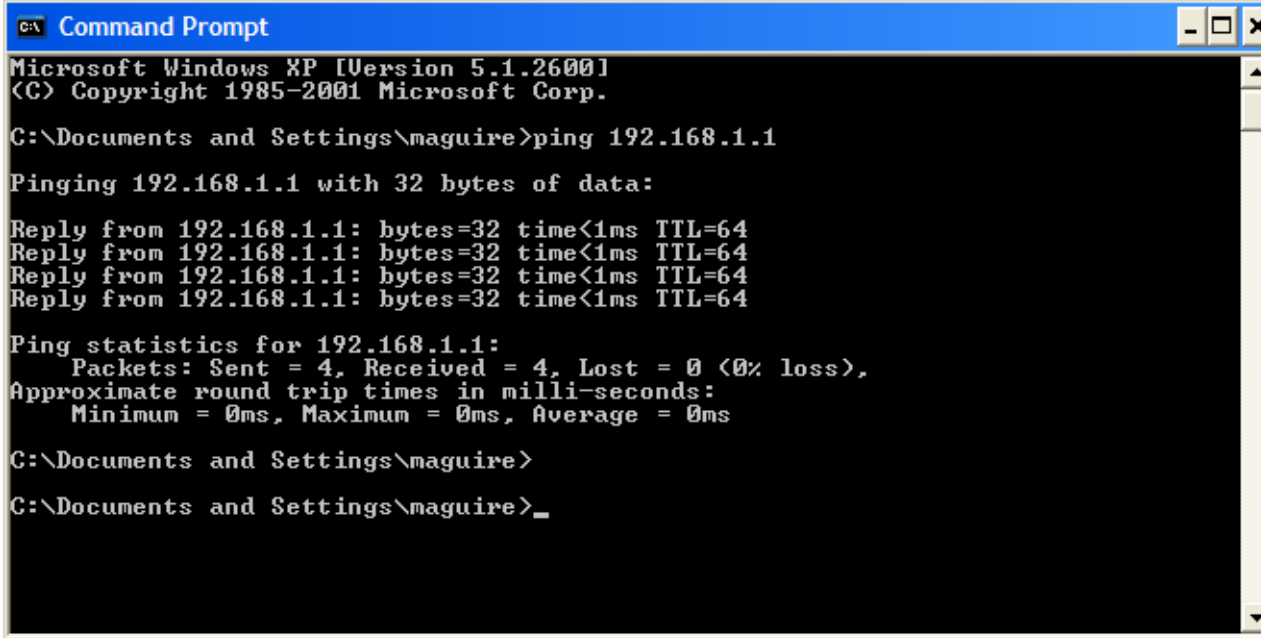

Figure 9: Two alternatives to get packets

Note the BSF packet filter gets a copy of both the received and transmitted packets.

# Wireshark (formerly Ethereal)

First we start Wireshark capturing packets, then we ping another machine on the LAN:



```
c:\ Command Prompt
Microsoft Windows XP [Version 5.1.2600]
(C) Copyright 1985-2001 Microsoft Corp.

C:\Documents and Settings\maguire>ping 192.168.1.1

Pinging 192.168.1.1 with 32 bytes of data:

Reply from 192.168.1.1: bytes=32 time<1ms TTL=64
Reply from 192.168.1.1: bytes=32 time<1ms TTL=64
Reply from 192.168.1.1: bytes=32 time<1ms TTL=64
Reply from 192.168.1.1: bytes=32 time<1ms TTL=64

Ping statistics for 192.168.1.1:
    Packets: Sent = 4, Received = 4, Lost = 0 (0% loss),
    Approximate round trip times in milli-seconds:
        Minimum = 0ms, Maximum = 0ms, Average = 0ms

C:\Documents and Settings\maguire>
C:\Documents and Settings\maguire>_
```

Figure 10: Ping another machine on the LAN

wireshark-capture-20080120a.pcap - Wireshark

File Edit View Go Capture Analyze Statistics Help

Filter: Expression... Clear Apply

| No. | Time      | Source            | Destination     | Protocol | Length | Info                                  |
|-----|-----------|-------------------|-----------------|----------|--------|---------------------------------------|
| 58  | 1.550736  | 192.168.1.2       | 192.168.1.20    | TCP      | 60     | [TCP segment of a reassembled stream] |
| 59  | 1.550742  | 192.168.1.2       | 192.168.1.20    | SMB      | 46     | Trans2 Response, FIND...              |
| 60  | 1.550754  | 192.168.1.20      | 192.168.1.2     | TCP      | 60     | valisys-lm > netbios-s...             |
| 61  | 1.551762  | 192.168.1.20      | 192.168.1.2     | SMB      | 46     | Trans2 Request, FIND...               |
| 62  | 1.558412  | 192.168.1.2       | 192.168.1.20    | TCP      | 60     | [TCP segment of a reassembled stream] |
| 63  | 1.558425  | 192.168.1.2       | 192.168.1.20    | TCP      | 60     | [TCP segment of a reassembled stream] |
| 64  | 1.558437  | 192.168.1.20      | 192.168.1.2     | TCP      | 60     | valisys-lm > netbios-s...             |
| 65  | 1.558615  | 192.168.1.2       | 192.168.1.20    | TCP      | 60     | [TCP segment of a reassembled stream] |
| 66  | 1.558815  | 192.168.1.2       | 192.168.1.20    | TCP      | 60     | [TCP segment of a reassembled stream] |
| 67  | 1.558820  | 192.168.1.2       | 192.168.1.20    | SMB      | 46     | Trans2 Response, FIND...              |
| 68  | 1.558832  | 192.168.1.20      | 192.168.1.2     | TCP      | 60     | valisys-lm > netbios-s...             |
| 69  | 5.403518  | D-Link_9e:87:29   | Broadcast       | ARP      | 30     | who has 192.168.1.8?                  |
| 70  | 12.943135 | 192.168.1.20      | 192.168.1.1     | ICMP     | 60     | Echo (ping) request                   |
| 71  | 12.943573 | D-Link_9e:87:29   | Broadcast       | ARP      | 30     | who has 192.168.1.20?                 |
| 72  | 12.943581 | LgElectr_0b:5e:61 | D-Link_9e:87:29 | ARP      | 30     | 192.168.1.20 is at 00:...             |
| 73  | 12.943771 | 192.168.1.1       | 192.168.1.20    | ICMP     | 60     | Echo (ping) reply                     |
| 74  | 13.932403 | 192.168.1.20      | 192.168.1.1     | ICMP     | 60     | Echo (ping) request                   |
| 75  | 13.932784 | 192.168.1.1       | 192.168.1.20    | ICMP     | 60     | Echo (ping) reply                     |
| 76  | 14.932308 | 192.168.1.20      | 192.168.1.1     | ICMP     | 60     | Echo (ping) request                   |
| 77  | 14.932686 | 192.168.1.1       | 192.168.1.20    | ICMP     | 60     | Echo (ping) reply                     |
| 78  | 15.932298 | 192.168.1.20      | 192.168.1.1     | ICMP     | 60     | Echo (ping) request                   |
| 79  | 15.932588 | 192.168.1.1       | 192.168.1.20    | ICMP     | 60     | Echo (ping) reply                     |
| 80  | 17.718678 | 192.168.1.2       | 192.168.1.255   | BROWSER  | 100    | Local Master Announcement             |
| 81  | 17.718690 | 192.168.1.2       | 192.168.1.255   | BROWSER  | 100    | Domain/workgroup Annou...             |

Frame 69 (60 bytes on wire (60 bytes captured) on interface eth0)

Ethernet II, Src: D-Link\_9e:87:29 (00:17:9a:9e:87:29), Dst: Broadcast (ff:ff:ff:ff:ff:ff)

Address Resolution Protocol (request)

Hardware type: Ethernet (0x0001)  
 Protocol type: IP (0x0800)  
 Hardware size: 6  
 Protocol size: 4  
 Opcode: request (0x0001)  
 Sender MAC address: D-Link\_9e:87:29 (00:17:9a:9e:87:29)  
 Sender IP address: 192.168.1.1 (192.168.1.1)  
 Target MAC address: Broadcast (ff:ff:ff:ff:ff:ff)  
 Target IP address: 192.168.1.8 (192.168.1.8)

```

0000 ff ff ff ff ff ff 00 17 9a 9e 87 29 08 06 00 01
0010 08 00 06 04 00 01 00 17 9a 9e 87 29 c0 a8 01 01
0020 ff ff ff ff ff ff c0 a8 01 08 00 00 00 00 00 00
0030 00 00 00 00 00 00 00 00 00 00 00
  
```

Frame (frame), 60 bytes      Packets: 81 Displayed

# Linux Socket filter

If you want to sniff the network your self (with a program) - try the Linux Socket Filter [10] and [11].

# Tools Used: sock Program

- A simple test program to generate TCP, UDP data
- To test and debug TCP, UDP implementations

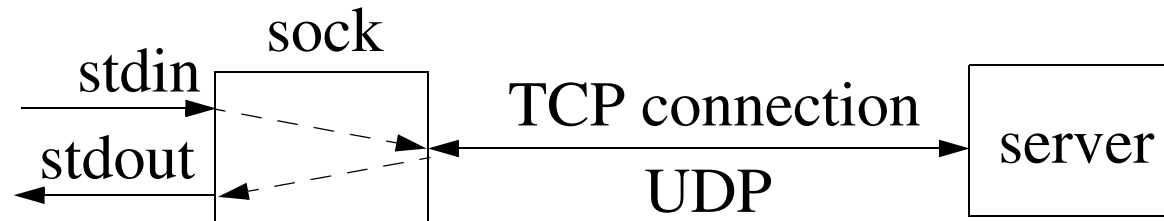

- Interactive client: default
- Interactive server: -s
- Source client: -i
- Sink server: -i -s
- Default TCP, -u for UDP

**Source Code Available: (Tcpdump and sock)**

For Win95/98/2000/NT: <http://netgroup-serv.polito.it/windump/>

For BSD alike: <ftp://ftp.uu.net/published/books/stevens.tcpipiv1.tar.Z>

# Tools Used: sock + tcpdump

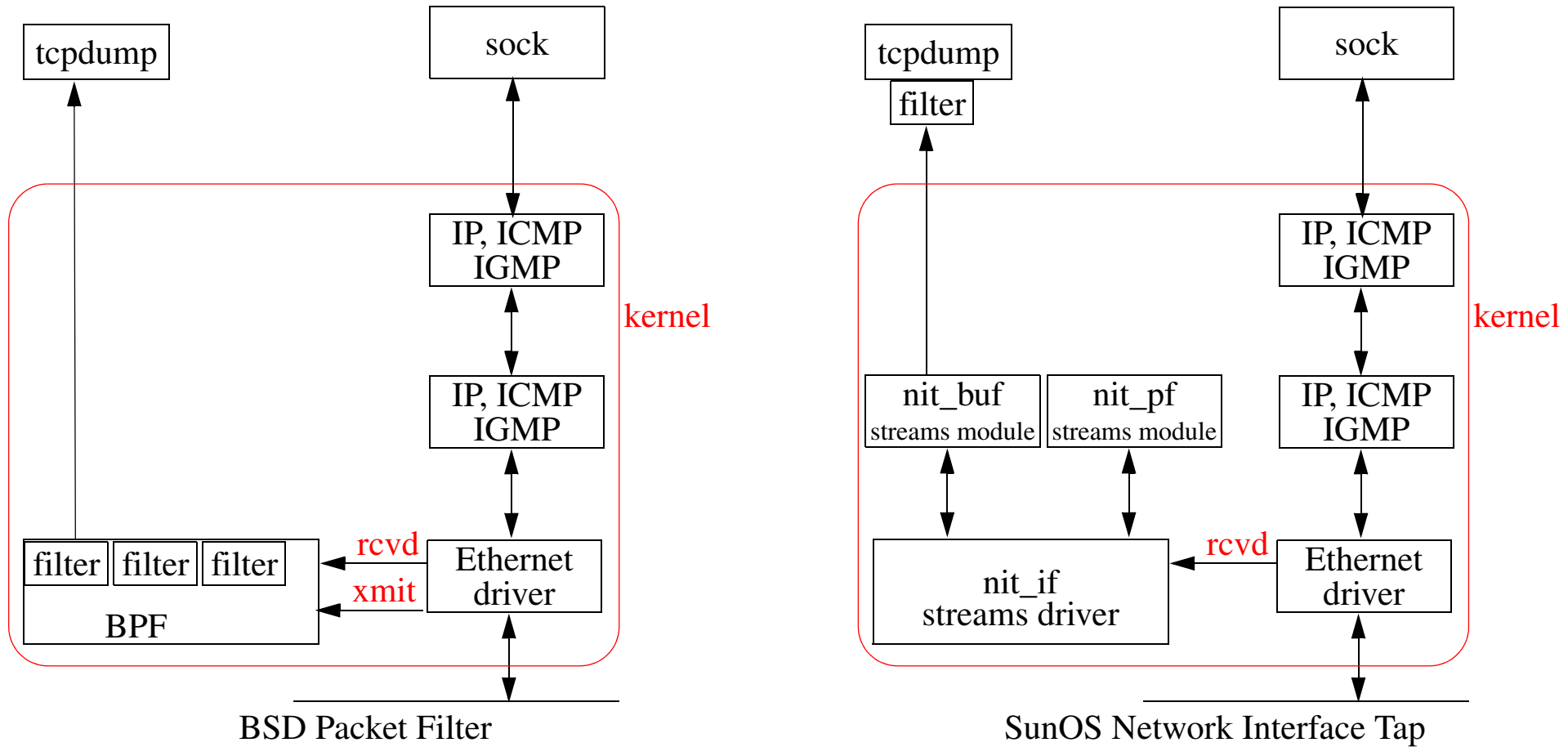

Figure 11: Two alternatives to generate and dump packets

# Generating packets

```
#include <stdlib.h>
#include <string.h>
#include <stdio.h>
#include <sys/types.h>
#include <sys/socket.h>
#include <netinet/in.h>

#define bigBufferSize 8192

#define destination_host "130.237.15.247"
#define Numer_of_Packets_to_Send 10000

main(argc, argv)
int argc;
char **argv;
{
    int client_socket_fd; /* Socket to client, server */
    struct sockaddr_in server_addr; /* server's address */
    int i;

    char bigBuffer[bigBufferSize];
    int sendto_flags=0;

    /* create a UDP socket */
    if ((client_socket_fd = socket(AF_INET, SOCK_DGRAM, IPPROTO_UDP)) == -1) {
        perror("Unable to open socket");
        exit(1);
    };

    /* initialize the server address structure */
    memset( (char*)&server_addr, 0, sizeof(server_addr));
    server_addr.sin_family=AF_INET;
    server_addr.sin_port=htons(9); /* 9 is the UDP port number for Discard */
```

```

if (inet_aton(destination_host, (struct sockaddr*)&server_addr.sin_addr) == 0) {
    fprintf(stderr, "could not get an address for: %s", destination_host);
    exit(1);
}

sprintf(bigBuffer, "This is a simple test string to be sent to the other party\n");

for (i=0; i < Numer_of_Packets_to_Send; i++) {
    if ((sendto(client_socket_fd, bigBuffer, strlen(bigBuffer),
                sendto_flags, (struct sockaddr*)&server_addr, sizeof(server_addr))) == -1) {
        perror("Unable to send to socket");
        close(client_socket_fd);
        exit(1);
    }
}

fprintf(stderr, "finished sending %d UDP packets\n", Numer_of_Packets_to_Send);

close(client_socket_fd);      /* close the socket */
exit(0);
}

```



# Wireshark's IO Graph functionality

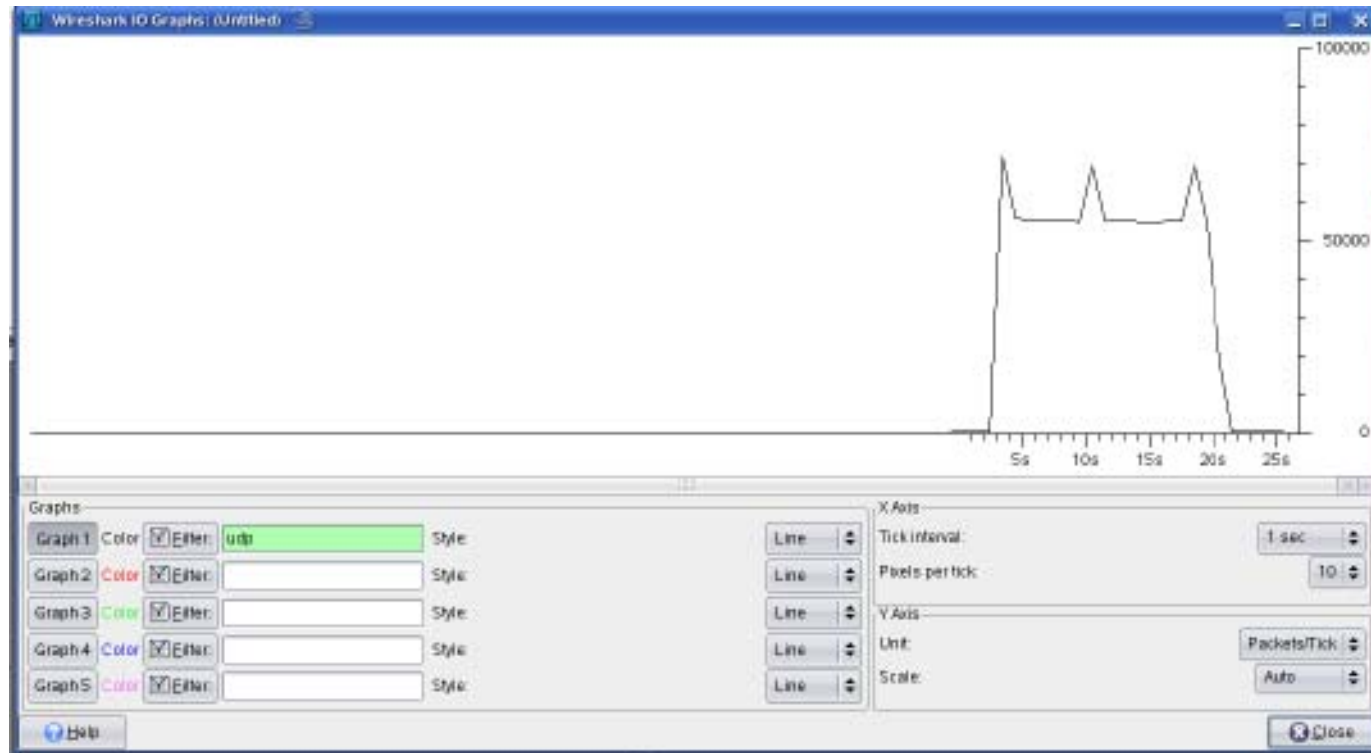

Figure 12: Plot showing number of packets per second

# Some statistics on this packet trace

|    | A   | B        | C          | D           | E        | F                                     | G       | H | I       | J            | K |
|----|-----|----------|------------|-------------|----------|---------------------------------------|---------|---|---------|--------------|---|
| 1  | No. | Time     | Source     | Destination | Protocol | Info                                  |         |   |         |              |   |
| 2  | 9   | 5.035328 | 192.168.1. | 130.237.19  | UDP      | Source port: 1028 Destination port: 9 | 0       |   | Minimum | 0.000000E+00 |   |
| 3  | 10  | 5.035344 | 192.168.1. | 130.237.19  | UDP      | Source port: 1028 Destination port: 9 | 1.6E-05 |   | Maximum | 1.772000E-03 |   |
| 4  | 11  | 5.035352 | 192.168.1. | 130.237.19  | UDP      | Source port: 1028 Destination port: 9 | 8E-06   |   | Average | 9.714500E-06 |   |
| 5  | 12  | 5.035359 | 192.168.1. | 130.237.19  | UDP      | Source port: 1028 Destination port: 9 | 7E-06   |   | std     | 1.847505E-05 |   |
| 6  | 13  | 5.035365 | 192.168.1. | 130.237.19  | UDP      | Source port: 1028 Destination port: 9 | 6E-06   |   |         |              |   |
| 7  | 14  | 5.035372 | 192.168.1. | 130.237.19  | UDP      | Source port: 1028 Destination port: 9 | 7E-06   |   |         |              |   |
| 8  | 15  | 5.035381 | 192.168.1. | 130.237.19  | UDP      | Source port: 1028 Destination port: 9 | 9E-06   |   |         |              |   |
| 9  | 16  | 5.035389 | 192.168.1. | 130.237.19  | UDP      | Source port: 1028 Destination port: 9 | 8E-06   |   |         |              |   |
| 10 | 17  | 5.035397 | 192.168.1. | 130.237.19  | UDP      | Source port: 1028 Destination port: 9 | 8E-06   |   |         |              |   |
| 11 | 18  | 5.035406 | 192.168.1. | 130.237.19  | UDP      | Source port: 1028 Destination port: 9 | 9E-06   |   |         |              |   |
| 12 | 19  | 5.035416 | 192.168.1. | 130.237.19  | UDP      | Source port: 1028 Destination port: 9 | 1E-05   |   |         |              |   |
| 13 | 20  | 5.035427 | 192.168.1. | 130.237.19  | UDP      | Source port: 1028 Destination port: 9 | 1.1E-05 |   |         |              |   |
| 14 | 21  | 5.035436 | 192.168.1. | 130.237.19  | UDP      | Source port: 1028 Destination port: 9 | 9E-06   |   |         |              |   |
| 15 | 22  | 5.035443 | 192.168.1. | 130.237.19  | UDP      | Source port: 1028 Destination port: 9 | 7E-06   |   |         |              |   |

Figure 13: Some simple statistics

# Interarrival delay and variance

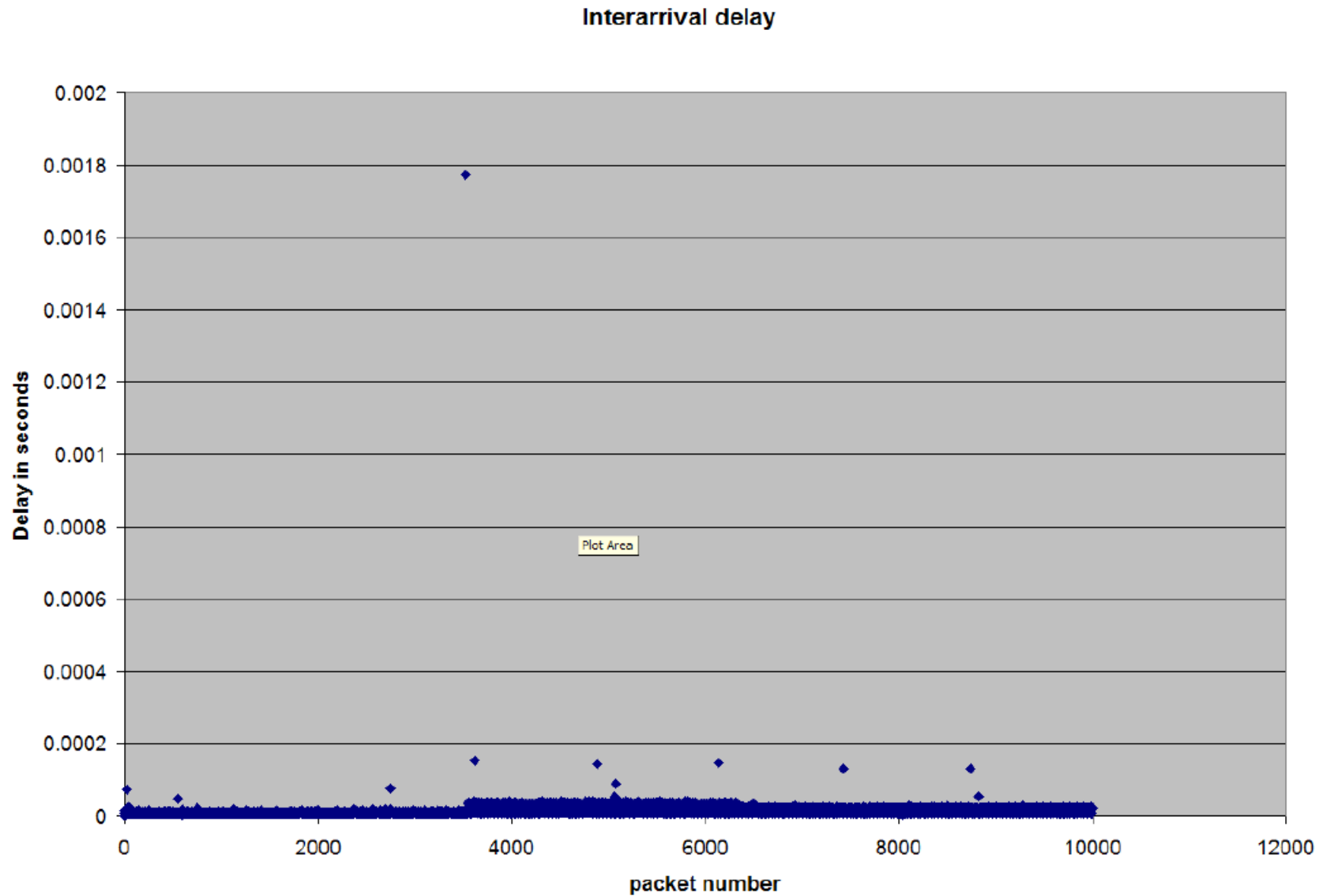

Figure 14: Note the packets which have very high delays

# Traffic generators

- Distributed Internet Traffic Generator (D-ITG) [12] -  
<http://www.grid.unina.it/software/ITG/>
- Gensyn generate multiple TCP streams in parallel  
<http://www.item.ntnu.no/~poulh/GenSyn/gensyn.html>
- Iperf <http://dast.nlanr.net/Projects/Iperf/>
- MGEN: network performance tests and measurements using UDP/IP traffic <http://mgen.pf.itd.nrl.navy.mil/>
- RUDE & CRUDE - Real-time UDP Data Emitter (RUDE) and Collector for RUDE (CRUDE) <http://rude.sourceforge.net/>
- SUN's Packet Shell - <http://playground.sun.com/psh/>
- TG <http://www.caip.rutgers.edu/~arni/linux/tg1.html>
- UDPgen <http://www.fokus.fhg.de/usr/sebastian.zander/private/udpgen>
- Netcom's SmartBits - hardware tester

For additional traffic generators see: <http://www.icir.org/models/trafficgenerators.html> and  
<http://www.ip-measurement.org/>

# Summary

This lecture we have discussed:

- Routing Principles
  - Routing **Mechanism**: Use the *most specific* route
    - IP provides the mechanism to route **packets**
  - Routing **Policy**: What routes should be put in the routing **table**?
    - Use a routing daemon to provide the *routing policy*
- Routing table
- ARP and RARP
- IPX/SPX Addresses - we will see something similar when we talk about IPv6
- tcpdump, ethereal, sock

For further information about routing see:

Bassam Halabi, *Internet Routing Architectures*, Cisco Press, 1997, ISBN 1-56205-652-2. -- especially useful for IGRP.

We will examine routing policies and algorithms in a later lecture.

# References

- [1] Renesas Technology Corp. TCAM description  
[http://www.renesas.com/fmwk.jsp?cnt=tcam\\_series\\_landing.jsp&fp=/applications/network/network\\_memory/tcam/](http://www.renesas.com/fmwk.jsp?cnt=tcam_series_landing.jsp&fp=/applications/network/network_memory/tcam/)
- [2] Fany Yu, Randy H. Katz, and T. V. Lakshman, "Gigabit Rate Multiple-Pattern Matching with TCAM",  
[http://sahara.cs.berkeley.edu/jan2004-retreat/slides/Fang\\_retreat.ppt](http://sahara.cs.berkeley.edu/jan2004-retreat/slides/Fang_retreat.ppt)
- [3] Geoff Huston, "Analyzing the Internet BGP Routing Table", Cisco Systems web page,  
[http://www.cisco.com/en/US/about/ac123/ac147/ac174/ac176/about\\_cisco\\_ipj\\_archive\\_article09186a00800c83cc.html](http://www.cisco.com/en/US/about/ac123/ac147/ac174/ac176/about_cisco_ipj_archive_article09186a00800c83cc.html)
- [4] Tian Bu, Lixin Gao, and Don Towsley, "On Characterizing BGP Routing Table Growth", Proceedings of Globe Internet 2002, 2002  
[http://www-unix.ecs.umass.edu/~lgao/globalinternet2002\\_tian.pdf](http://www-unix.ecs.umass.edu/~lgao/globalinternet2002_tian.pdf)
- [5] H. Narayan, R. Govindan, and G. Varghese, "The Impact of Address Allocation and Routing on the Structure and Implementation of Routing Tables", Proceedings of the 2003 Conference on Applications, technologies, architectures, and protocols for computer communications, 2003, pp 125-136, ISBN:1-58113-735-4 and SIGCOMM 03, August 25 29, 2003, Karlsruhe, Germany  
<http://www.cs.ucsd.edu/~varghese/PAPERS/aram.pdf>
- [6] Ravikumar V.C Rabi Mahapatra J.C. Liu, "Modified LC-Trie Based Efficient Routing Lookup",  
<http://faculty.cs.tamu.edu/rabi/Publications/Mascot-final-proceeding.pdf>
- [7] APNIC, Routing Table Report 04:00 +10GMT Sat 19 Mar, 2005, North American Network Operators Group, Weekly Routing Table Report, From: Routing Table Analysis, Mar 18 13:10:37 2005, "This is an automated weekly mailing describing the state of the Internet Routing Table as seen from APNIC's router in Japan. Daily listings are sent to bgp-stats@lists.apnic.net"  
<http://www.merit.edu/mail.archives/nanog/2005-03/msg00401.html>
- [8] Geoff Huston, Routing Table Status Report, Policy SIG, APNIC19, Kyoto, Japan, Feb 24 2005  
<http://www.apnic.net/meetings/19/docs/sigs/routing/routing-pres-info-huston-routing-table.pdf>
- [9] Bassam Halabi, *Internet Routing Architectures*, Cisco Press, 1997, ISBN 1-56205-652-2.

- [10] Gianluca Insolvibile, “The Linux Socket Filter: Sniffing Bytes over the Network”, Linux Journal, 31 May 2001  
<http://www.linuxjournal.com/article/4659>
- [11] Gianluca Insolvibile, “Inside the Linux Packet Filter, Part II”, Linux Journal, 1 March 2002  
<http://www.linuxjournal.com/article/5617>
- [12] Stefano Avallone, Antonio Pescapé, and Giorgio Ventre, “Analysis and experimentation of Internet Traffic Generator”, International Conference on Next Generation Teletraffic and Wired/Wireless Advanced Networking (NEW2AN’04), February 02-06, 2004 <http://www.grid.unina.it/software/ITG/D-ITGpublications/New2an-ITG.pdf>

# IK1550 Internetworking/Internetteknik

## Spring 2010, Period 4

### Module 3: IP, ICMP, and Tools

Lecture notes of G. Q. Maguire Jr.



**KTH Information and  
Communication Technology**

© 2010 G.Q.Maguire Jr. .

All rights reserved. No part of this course may be reproduced, stored in a retrieval system, or transmitted, in any form or by any means, electronic, mechanical, photocopying, recording, or otherwise, without written permission of the author.

Last modified: 2010.03.21:17:34



# IP, ICMP, and Tools Outline

- IP
- ICMP
- Useful Diagnostic Tools
  - Ping
  - Traceroute
  - tcpdump and ethereal
  - sock

# Internet Protocol version 4 (IPv4) (RFC 791)

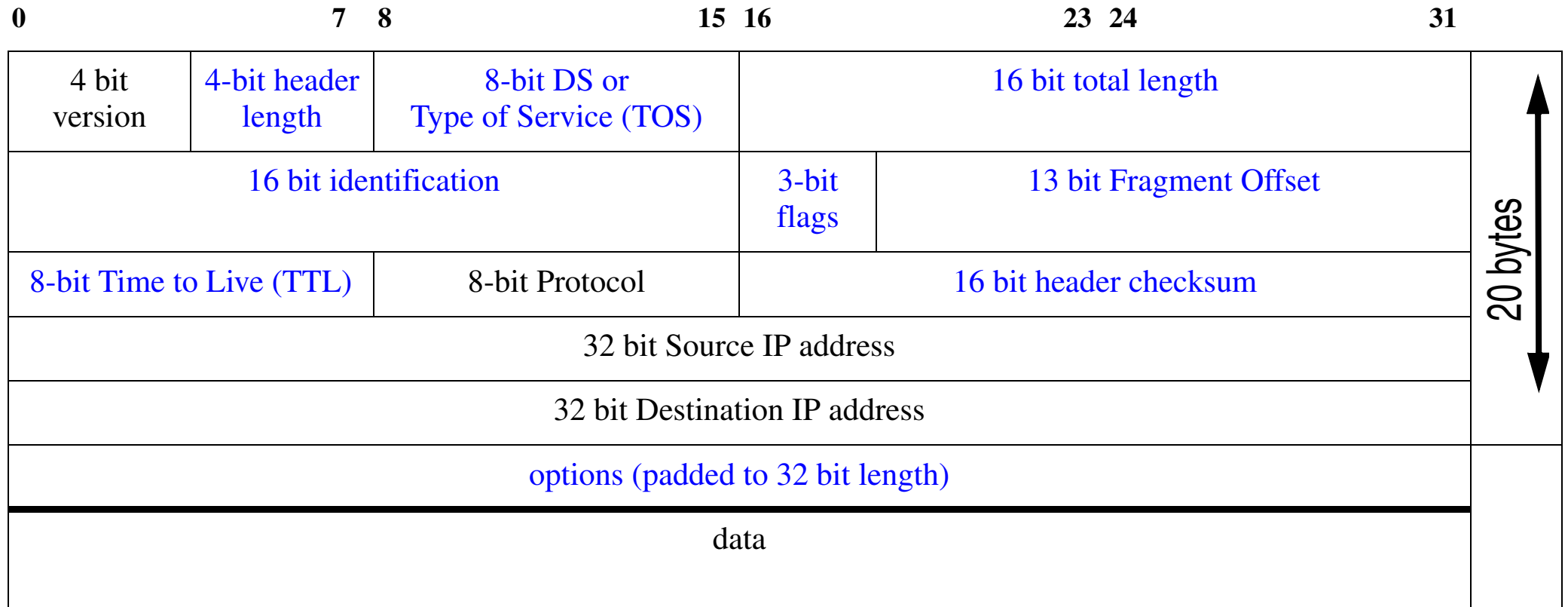

Figure 1: IP header (see Stevens, Vol. 1, figure 3.1, pg. 34)

Note: We examined the Version, Protocol, and IP address fields in the previous lecture. Today we will examine the **length fields, TOS, identification, flags, offset,**

checksum, and options fields.

# Length Fields

- **Header Length** (4 bits)
  - Size of IPv4 header including IP options
  - Expressed in number of 32-bit words (4-byte words)
  - Minimum is 5 words (i.e., 20 bytes)
  - Maximum is 15 words (i.e., 60 bytes)
    - limited size  $\Rightarrow$  limited use
- **Total Length** (16 bits)
  - Total length of datagram **including** header
  - If datagram is fragmented: length of this fragment
  - Expressed in bytes
  - Hosts **only** have to accept packets up to 576 bytes in size
  - Maximum: 65,535 bytes
    - Most modern systems accept slightly larger than 8,196 + header bytes (to provide efficient file service for 8 Kbyte blocks)
    - Note: Some systems **only** accept this much!

# MTU $\frac{1}{2}$ $\equiv$ Maximum Transmission Unit

MTU is a characteristic of the link layer

## Typical MTUS

| MTU   | Network                      |   |
|-------|------------------------------|---|
| 65535 | Official maximum MTU         |   |
| 17914 | 16Mbps IBM Token Ring        |   |
| 8166  | IEEE 802.4                   |   |
| 4464  | IEEE 802.5 (4Mbps max)       |   |
| 4352  | FDDI (Revised)               |   |
| 2048  | Wideband Network             |   |
| 2002  | IEEE 802.5 (4Mb recommended) |   |
| 1536  | Experimental Ethernet Nets   |   |
| 1500  | Ethernet Networks            |   |
| 1500  | Point-to-Point (default)     |   |
| 1492  | IEEE 802.3                   |   |
| 1006  | SLIP                         | simply a logical limit for interactive response |
| 1006  | ARPANET                      |   |
| 576   | X.25 Networks                | $\Leftarrow$ we will see this number again!     |
| 544   | DEC IP Portal                |   |
| 512   | NETBIOS                      |   |
| 508   | IEEE 802/Source-Route Bridge |   |
| 296   | Point-to-Point (low delay)   |   |
| 68    | Official minimum MTU         |   |

# Fragmentation

- If an IP datagram is larger than the MTU of the link layer, it must be divided into several pieces  $\Rightarrow$  fragmentation
- Fragmentation may occur multiple times
  - as a fragment might need to go across a link with an even smaller MTU!
- Both hosts and routers may fragment
  - **However, only** destination host reassemble!
    - as fragments only need to come together at the final host - thus the fragments can take different paths though the network
    - also reassembly requires waiting for the other fragments - so doing this earlier in the network could add unnecessary delay
  - Each fragment is routed separately (i.e., as independent datagram)
- TCP uses either 576 byte MTU or **path MTU discovery**

# Fields relevant to Fragmentation

- **Identification** (16 bits)
  - Identification + source IP address *uniquely* identifies each datagram sent by a host  
⇒ Identification field is copied to all fragments of a datagram upon fragmentation (since they are all part of the same original datagram)
- **Flags: 3 bits**
  - **Reserved Fragment** (RF) - set to 0
  - **Don't Fragment** (DF)
    - Set to 1 if datagram should **not** be fragmented
    - If set and fragmentation needed ⇒ datagram will be **discarded** and an **error message** will be returned to the sender
  - **More Fragments** (MF)
    - Set to 1 for all fragments, **except** the last
- **Fragmentation Offset** (13 bits)
  - 8-byte units: (i.e., the byte offset is  $ip\_frag \ll 3$ )
  - indicates **relative** position of a fragment with respect to the whole datagram

Fragments can overlap - the receiver simply assembles what it receives (ignoring duplicate parts).

If there are gaps - then at some point there will be a re-assembly error.

# Path MTU

- Each link in path from source to destination can have a different MTU
- to avoid fragmentation you have to find the minimum of these
- RFC 1191: Path MTU discovery[2] uses:
  - “good” guesses (i.e., likely values)
  - By setting Don't Fragment (DF) bit in IP datagram  $\Rightarrow$  change size while you get ICMP messages saying “Destination Unreachable” with a code saying fragmentation needed



# Serial line throughput

At 9,000 bits/sec, 8 bits per byte, plus 1 start and 1 stop bit, i.e., 960 bytes/sec, then transferring 1024 byte packets would take 1066 ms

- too long for interactive limits; since the average wait would be 533 ms

∴ shorten the MTU to 296 bytes  $\Rightarrow$  266 ms/frame or  $\sim$ 133 ms average wait

With 5 bytes of CSLIP header and 256 bytes of data (in the 261 byte frame)  $\Rightarrow$

- 98.1% utilization of link for data and
- 1.9% for header

For single bytes of interactive traffic, the round trip-time is 12.5 ms

Caveats:

- assumes that you give interactive traffic priority
- error correcting and compression in the modem can complicate the calculations - since the modem has to delay traffic to have more to compress and compression takes time

# Differentiated Services (DS) & Type of Service

Type of Service (TOS): 8 bits

Bits 0-2: Precedence

Bit 3: 0 = normal Delay                      1 = Low Delay

Bit 4: 0 = normal Throughput                1 = High Throughput

Bit 5: 0 = normal Reliability                1 = High Reliability

Bit 6: 0 = normal monetary Cost            1 = minimize monetary Cost.

| 0          | 1 | 2 | 3     | 4 | 5 | 6 | 7        |
|------------|---|---|-------|---|---|---|----------|
| Precedence |   |   | DELAY | T | R | C | Reserved |

- Few applications set the TOS field (in fact most implementations will not let you set these bits!) However, 4.3BSD Reno and later - do support these bits.
- Differentiated Services (diffserv) proposes to use 6 of these bits to provide 64 priority levels - calling it the Differentiated Service (DS) field [RFC2474] (using bits 0..5 as Differentiated Services CodePoint (DSCP))
- SLIP guesses by looking at the **protocol** field and then checks the source and destination **port** numbers.

There has been a lot of experimentation with this field, both for TOS and more recently for Early Congestion Notification (ECN): RFC 3168 [1] using bits 6 and

# 7 {ECN Capable Transport (ECT) and Congestion Experienced (CE)}.

# Recommended Value for TOS Field

| Application   |               | Minimum delay | Maximize throughput | Maximize reliability | Minimize monetary cost | Hex value <sup>a</sup> |
|---------------|---------------|---------------|---------------------|----------------------|------------------------|------------------------|
| telnet/rlogin |               | 1             | 0                   | 0                    | 0                      | 0x10                   |
| FTP           | control       | 1             | 0                   | 0                    | 0                      | 0x10                   |
|               | data          | 0             | 1                   | 0                    | 0                      | 0x08                   |
|               | any bulk data | 0             | 1                   | 0                    | 0                      | 0x08                   |
| TFTP          |               | 1             | 0                   | 0                    | 0                      | 0x10                   |
| SMTP          | command phase | 1             | 0                   | 0                    | 0                      | 0x10                   |
|               | data phase    | 0             | 1                   | 0                    | 0                      | 0x08                   |
| DNS           | UDP query     | 1             | 0                   | 0                    | 0                      | 0x10                   |
|               | TCP query     | 0             | 0                   | 0                    | 0                      | 0x00                   |
|               | zone transfer | 0             | 1                   | 0                    | 0                      | 0x08                   |
| ICMP          | error         | 0             | 0                   | 0                    | 0                      | 0x00                   |
|               | query         | 0             | 0                   | 0                    | 0                      | 0x00                   |
| any IGP       |               | 0             | 0                   | 1                    | 0                      | 0x04                   |
| SNMP          |               | 0             | 0                   | 1                    | 0                      | 0x04                   |
| BOOTP         |               | 0             | 0                   | 0                    | 0                      | 0x00                   |
| NNTP          |               | 0             | 0                   | 0                    | 1                      | 0x02                   |

a. Note that this is the hex value as see in the TOS/DS byte.

See also Table 8.2 on page 182 of Forouzan.

# Precedence

Precedence values are defined but are largely ignored, few applications use them.

|     |                      |
|-----|----------------------|
| 111 | Network Control      |
| 110 | Internetwork Control |
| 101 | CRITIC/ECP           |
| 100 | Flash Override       |
| 011 | Flash                |
| 010 | Immediate            |
| 001 | Priority             |
| 000 | Routine              |

In the original ARPANET there were two priority levels defined (in order to support low delay services and regular traffic).

# Problems with precedence

- As soon as people found that high priority meant something  
⇒ all traffic was sent with this bit set!

So unless there is a added cost/policy check/... associated with usage of a precedence level - it is very likely going to be abused.

# Precedence and telephony systems

Similar precedence systems exist in most national telephony systems.

Q: What are the A, B, C and D touch tone keys used for? ...

A: These are extensions to the standard touch-tones (0-9, \*, #) which originated with the U.S. military's Autovon phone network. The original names of these keys were FO (Flash Override), F (Flash), I (Immediate), and P (Priority). The various priority levels established calls with varying degrees of immediacy, terminating other conversations on the network if necessary. FO was the greatest priority, normally reserved for the President or very high ranking officials. P had a lesser priority, but still took precedence over calls that were placed without any priority established.

-- from TELECOM Digest - Frequently Asked Questions - v.8, 8 February 1997

# Differentiated services

If bits 3, 4, and 5 are all zero (i.e., XXX000)  $\Rightarrow$  treat the bits 1, 2, 3 as the traditional precedence bits, else the 6 bits define 64 services:

- Category 1: numbers 0, 2, 4, ... 62 - defined by IETF
- Category 2: numbers 3, 7, 11, 15, ... 63 defined by local authorities
- Category 3: numbers 1, 5, 9, ... 61 are for temporary/experimental use

The numbering makes more sense when you see them as bit patterns:

| Category | codepoint | Assigning authority    |
|----------|-----------|------------------------|
| 1        | XXXXX0    | IETF                   |
| 2        | XXXX11    | local                  |
| 3        | XXXX01    | temporary/experimental |

The big problems occur at gateways where the interpretation of local DS values is different on the incoming and outgoing links!



# TTL field

Time To Live (TTL) (8 bits):

- Limits the lifetime of a datagram, to avoid infinite loops
- A router receiving a packet with  $TTL > 1$  decrements the TTL field and forwards the packet
- If  $TTL \leq 1$  shall not be forwarded  
⇒ an ICMP time exceeded error is returned to the sender {we will cover ICMP shortly}
- Recommended value is 64
- Should really be called Hop Limit (as in IPv6)

Historically: Every router holding a datagram for more than 1 **second** was expected to decrement the TTL by the *number of seconds* the datagram resided in the router.

# Header Checksum

- Ensures integrity of header fields
  - Hop-by-hop (not end-to-end)
  - Header fields must be correct for proper and safe processing of IP!
  - Payload is **not** covered
- Other checksums
  - Hop-by-hop: using link-layer CRC
    - IP assumes a strong link layer checksum/CRC - as the IP checksum is weak
  - End-to-end: Transport layer checksums, e.g., TCP & UDP checksums, cover **payload**
- Internet Checksum Algorithm, RFC 1071
  - Treat headers as sequence of **16-bit** integers
  - Add them together
  - Take the one's complement of the result

Note that recent work concerning IP over wireless links assume that the payload can have errors and will still be received (see work concerning selective coverage of UDP checksum).

# IPv4 Options

- IPv4 options were intended for network testing & debugging
- Options are variable sized and follow the fixed header
- Contiguous (i.e., no separators)
- Not required fields, but all IP implementations **must** include processing of options
  - Unfortunately, many implementations do not!
- Maximum of 40 bytes available  $\Rightarrow$  very limited use
  - Since the maximum header length is 60 bytes and the fixed part is 20 bytes - there is very little space left!

# IP Options Encoding

Two styles:

- Single byte (only code)
- Multiple byte

Option Code: 1 byte

- **Copy** (to fragments) (1 bit)
  - 0: copy only to the first fragment
  - 1: copy the option to all fragementts
- **Class** (2 bits)
  - 0 (00): Datagram or network control
  - 2 (10): Debugging and measurement
  - 1 (01) and 3 (11) reserved
- **Option Number** (5 bits)

Option Length: 1 byte, defines total length of option

Data: option specific

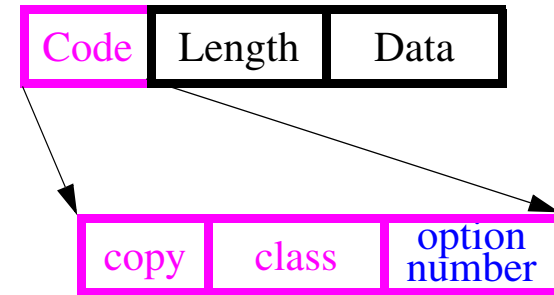

# Categories of IP Options

- Single byte (only code)
  - No operation (Option Number=0)
  - End of operation (Option Number=1)
- Multiple byte
  - Loose Source Route (Option Number=3)
    - Path includes these router, but there can be multiple hops between the specified addresses
  - Time stamp (Option Number=4)
    - Like record route (below), but adds a timestamp at each of the routers (upto the space available - after this an overflow field is incremented - but it is only 4 bits)
  - Record Route (Option Number=7)
  - Strict Source Route (Option Number=9)
    - The exact path is specified

However, due to the very limited space available for the options - these options are of little practical value in today's internet. (Consider the diameter of today's internet versus the number of IP addresses or timestamps that could be in the options field; i.e., record route can only store 9 IP addresses!)

# Internet Control Message Protocol (ICMP)

ICMP [3] is part of the same level as IP, but uses IP for transfers! ICMP is used by layer 3 entities to communicate with each other.

- ICMP PDU: type (8 bits); code (8 bits); checksum (16 bits); parameters (n\*32 bits); information (variable length)  
for errors: the information field always includes the **first 64 bits** of the data field of the original datagram which caused the ICMP message
- ICMP messages include:
  - Destination Unreachable (Network/Host/Protocol/Port/...)
  - Time Exceeded (TTL expired)
  - Parameter problem - IP header error
  - Source Quench (requests source to decrease its data rate)
  - Redirect - tell source to send its messages to a “better address”
  - Echo Request/ Echo reply - for testing (e.g., “ping” program sends an Echo request)
  - Timestamp Request/ Timestamp reply
  - Information Request / Information reply
  - Address Mask Request / Reply
  - Traceroute
  - Datagram conversion error
  - Mobile Host Redirect/Registration Request/Registration Reply
  - IPv6 Where-Are-You/I-Am-Here

# ICMP Port Unreachable Error

**Example: (Stevens, Vol. 1, Section 6.5, pp. 77-78)**

```
bsdi% tftp
tftp> connect svr4 888    specify host and port number
tftp> get temp.foo       try to fetch a file
Transfer times out.     about 25s later
tftp> quit
```

## tcpdump output

|     |           |          |   |
|-----|-----------|----------|---|
| 1   | 0.0       |          | arp who-has svr4 tell bsdi                        |
| 2   | 0.002050  | (0.0020) | arp reply svr4 is-at 0:0:c0:c2:9b:26              |
| 3   | 0.002723  | (0.0007) | bsdi.2924 > svr4.8888 udp 20                      |
| 4   | 0.006399  | (0.0037) | svr4 > bsdi: icmp: svr4 udp port 8888 unreachable |
| 5   | 5.000776  | (4.9944) | bsdi.2924 > svr4.8888 udp 20                      |
| 6   | 5.004304  | (0.0035) | svr4 > bsdi: icmp: svr4 udp port 8888 unreachable |
| ... |           |          | repeats every 5 seconds                           |
| 11  | 20.001177 | (4.9966) | bsdi.2924 > svr4.8888 udp 20                      |
| 12  | 20.004759 | (0.0036) | svr4 > bsdi: icmp: svr4 udp port 8888 unreachable |

# ICMP Redirect

ICMP Redirect message is sent by a router (R1) to the sender of an IP datagram (host) when the datagram should have been sent to a different router (R2).

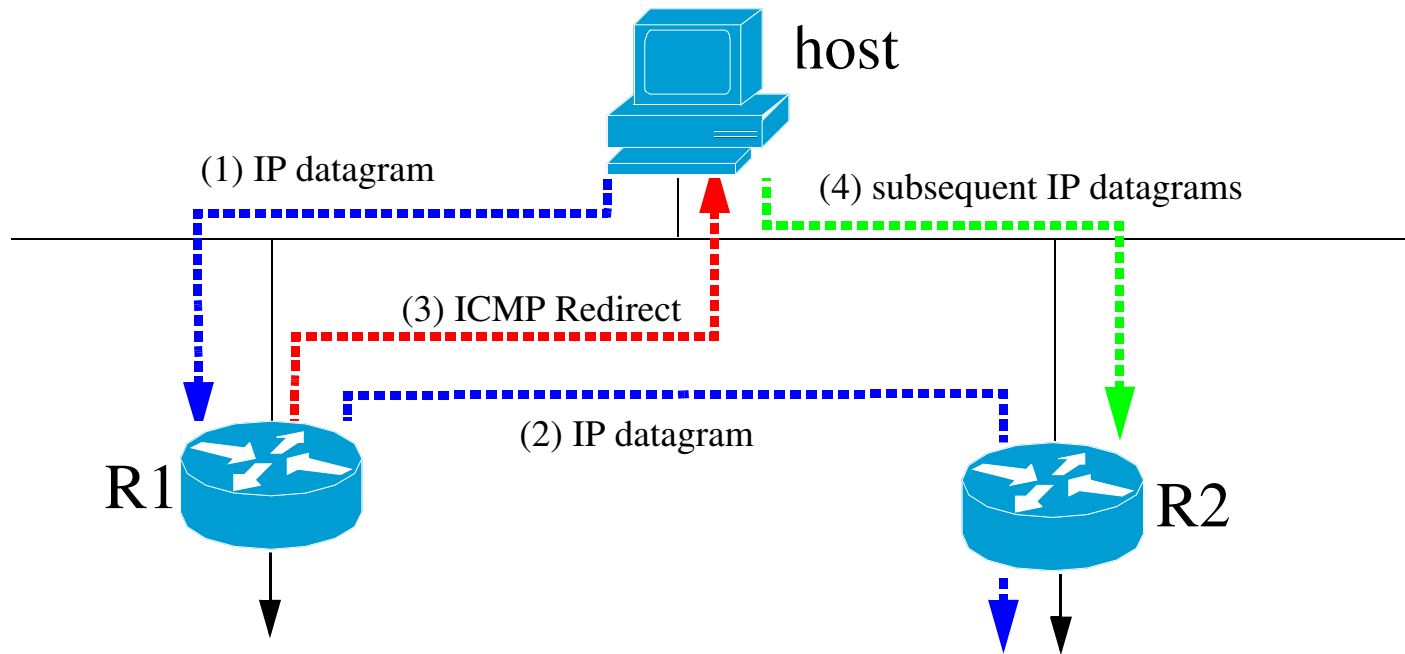



# PING: Packet InterNet Groper or sonar echo

Ping was written by Mike Muuss<sup>1</sup> to test host reach-ability. Uses ICMP, most IP implementations support Ping server. Sends an ICMP echo request to a host

Format of ICMP message for Echo request/reply (see Stevens, Vol. 1, figure 7.1, pg. 86)

|                   |          |                        |
|-------------------|----------|------------------------|
| Type (0 or 8)     | code (0) | 16 bit checksum        |
| 16 bit identifier |          | 16 bit sequence number |
| Optional data     |          |                        |

Look at ping across different connections<sup>2</sup>:

- LAN
- WAN
- Hardwired SLIP
- Dialup SLIP - extra delay due to the modems and the correction/compression

With IP record route (RR) option tracing the route of the ping datagram.

---

1. Mike Muuss was killed in an automobile accident on November 20, 2000. <http://ftp.arl.mil/~mike/>

2. For examples, see Stevens, Vol. 1, Chapter 7, pp. 86-90.

# PING examples

## On a Solaris machine:

```
bash-2.03$ /usr/sbin/ping cyklop.nada.kth.se
```

*from a machine at IMIT*

```
cyklop.nada.kth.se is alive
```

```
bash-2.03$ /usr/sbin/ping -s cyklop.nada.kth.se
```

```
PING cyklop.nada.kth.se: 56 data bytes
```

```
64 bytes from cyklop.nada.kth.se (130.237.222.71): icmp_seq=0. time=3. ms
```

```
64 bytes from cyklop.nada.kth.se (130.237.222.71): icmp_seq=1. time=1. ms
```

```
64 bytes from cyklop.nada.kth.se (130.237.222.71): icmp_seq=2. time=1. ms
```

```
^C
```

```
----cyklop.nada.kth.se PING Statistics----
```

```
3 packets transmitted, 3 packets received, 0% packet loss
```

```
round-trip (ms) min/avg/max = 1/1/3
```

Why did the first ping take longer?

## On a HP-UX 11.0 machine:

ping -ov www.kth.se

*from a machine on Telia's ADSL network*

PING www.kth.se: 64 byte packets

64 bytes from 130.237.32.51: icmp\_seq=0. time=54. ms

64 bytes from 130.237.32.51: icmp\_seq=1. time=38. ms

64 bytes from 130.237.32.51: icmp\_seq=2. time=11. ms

64 bytes from 130.237.32.51: icmp\_seq=3. time=11. ms

64 bytes from 130.237.32.51: icmp\_seq=4. time=11. ms

^C

----www.kth.se PING Statistics----

5 packets transmitted, 5 packets received, 0% packet loss

round-trip (ms) min/avg/max = 11/25/54

5 packets sent via:

this is based on the record route information (caused by “-ov”)

217.208.194.247 - fls31o268.telia.com

213.64.62.150 - fre-d4-geth6-0.se.telia.net

213.64.62.154 - fre-c3-geth6-0.se.telia.net

195.67.220.1 - fre-b1-pos0-1.se.telia.net

130.242.94.4 - STK-PR-2-SRP5.sunet.se

130.242.204.130 - STK-BB-2-POS4-3.sunet.se

130.242.204.121 - stockholm-1-FE1-1-0.sunet.se

130.237.32.3 - [ name lookup failed ]

130.237.32.51 - oberon.admin.kth.se

# Ping with record route option

```
$ ping -R www.kth.se
```

```
PING www.kth.se (130.237.32.51) 56(124) bytes of data.  
64 bytes from oberon.admin.kth.se (130.237.32.51): icmp_seq=1  
ttl=253 time=2.50ms
```

```
RR:      ccsser2 (130.237.15.248)  
        ke4-ea4-p2p.gw.kth.se (130.237.211.50)  
        kthlan-gw-32-2.admin.kth.se (130.237.32.2)  
        oberon.admin.kth.se (130.237.32.51)  
        oberon.admin.kth.se (130.237.32.51)  
        ea4-ke4-p2p.gw.kth.se (130.237.211.49)  
        130.237.15.194  
        ccsser2 (130.237.15.248)
```

```
64 bytes from oberon.admin.kth.se (130.237.32.51): icmp_seq=2  
ttl=253 time=1.73ms      (same route)  
64 bytes from oberon.admin.kth.se (130.237.32.51): icmp_seq=3  
ttl=253 time=1.80ms      (same route)  
64 bytes from oberon.admin.kth.se (130.237.32.51): icmp_seq=4  
ttl=253 time=1.90ms      (same route)
```

# Useful Tool: Traceroute Programs

Developed by Van Jacobson to see the route that IP datagrams follow from one host to another. Traceroute uses ICMP, TTL field, and an *unreachable UDP port*.

```
svr % traceroute slip
traceroute to slip (140.252.13.65), 30 hops max, 40 byte packets
 1 bsdi (140.252.13.35) 20 ms 10 ms 10 ms      20 ms due to ARP
 2 slip (140.252.13.65) 120 ms 120 ms 120 ms
```

## tcpdump output

|    |          |          |  |
|----|----------|----------|--|
| 1  | 0.0      |          | arp who-has bsdi tell svr4                         |
| 2  | 0.000586 | (0.0006) | arp reply bsdi is-at 0:0:c0:6f:2d:40               |
| 3  | 0.003067 | (0.0025) | svr4.42804 > slip.33435 udp 12 [ttl 1]             |
| 4  | 0.004325 | (0.0013) | bsdi > svr4: icmp: time exceeded in-transit        |
| 5  | 0.069810 | (0.0655) | svr4.42804 > slip.33436 udp 12 [ttl 1]             |
| 6  | 0.071149 | (0.0013) | bsdi > svr4: icmp: time exceeded in-transit        |
| 7  | 0.085162 | (0.0140) | svr4.42804 > slip.33437 udp 12 [ttl 1]             |
| 8  | 0.086375 | (0.0012) | bsdi > svr4: icmp: time exceeded in-transit        |
| 9  | 0.118608 | (0.0322) | svr4.42804 > slip.33438 udp 12 ttl=2               |
| 10 | 0.226464 | (0.1079) | slip > svr4: icmp: slip udp port 33438 unreachable |
| 11 | 0.287296 | (0.0608) | svr4.42804 > slip.33439 udp 12 ttl=2               |
| 12 | 0.395230 | (0.1079) | slip > svr4: icmp: slip udp port 33439 unreachable |
| 13 | 0.409504 | (0.0608) | svr4.42804 > slip.33440 udp 12 ttl=2               |
| 14 | 0.517430 | (0.1079) | slip > svr4: icmp: slip udp port 33440 unreachable |

# ICMP Summary

- Destination (Network/Host/Protocol/Port/...) Unreachable
- Time Exceeded - i.e., TTL expired
  - Used to implement traceroute
- Parameter problem - IP header error
- Source Quench- asks source to decrease its sending rate
- Redirect - tells the source to send packets to a “better” address
- Echo Request/Echo reply - for testing
  - ping: sends an Echo Request, then measures the time until the matching reply is received
- Timestamp Request/Reply
  - Round Trip Time (RTT) computation
  - Clock synchronization
- Address Mask Request/Reply
  - Allows diskless systems to learn their subnet mask
- Router Solicitation and Advertisement
  - Hosts query routers
  - Routers advertise presence and routes

The above is a partial summary of ICMP's uses.

# Summary

This lecture we have discussed:

- IP
- ICMP
- tools: Ping, Traceroute

# References

- [1] K. Ramakrishnan, S. Floyd, and D. Black, “The Addition of Explicit Congestion Notification (ECN) to IP”, IETF RFC 3168, September 2001.
- [2] J. Mogul and S. Deering, “Path MTU Discovery”, IETF, RFC 1191, November 1990.
- [3] J. Postel, Internet Control Message Protocol, IETF, RFC 792, September 1981 <http://www.ietf.org/rfc/rfc0792.txt>



# IK1550 Internetworking/Internetteknik

## Spring 2010, Period 4

### Module 4: UDP and friends

Lecture notes of G. Q. Maguire Jr.



**KTH Information and  
Communication Technology**

© 2010 G.Q.Maguire Jr. .

All rights reserved. No part of this course may be reproduced, stored in a retrieval system, or transmitted, in any form or by any means, electronic, mechanical, photocopying, recording, or otherwise, without written permission of the author.

Last modified: 2010.03.21:17:34

# Outline

- UDP
- Socket API
- BOOTP
- DHCP
- DNS, DDNS

# Transport layer protocols

The transport layer is responsible for end-to-end delivery of entire messages

- uses Protocol Port and/or Port Number to demultiplex the incoming packet so that it can be delivered to a specific process
- Segmentation and Reassembly
  - Divides a message into transmittable segments and reassemble them at the receive
- Connection control - for connection-oriented transport protocols
- End-to-end **Flow** Control (in contrast to link level flow control)
- End-to-end **Error** Control (in contrast to link level error control)

# Main Transport layer protocols

Three main transport layer protocols:

- User Datagram Protocol (UDP) <<< today's topic
  - Connectionless **unreliable** service
- Transmission Control Protocol (TCP)
  - Connection-oriented **reliable stream** service
- Stream Control Transmission Protocol (SCTP)
  - a modern transmission protocol with many facilities which the user can choose from

# User Datagram Protocol (UDP)

- Datagram-oriented transport layer protocol
- Provides **connectionless unreliable** service
- No reliability guarantee
- Checksum covers both header and data, end-to-end, but optional
  - if you care about your data you should be doing end-to-end checksums or using an even stronger error detection (e.g., MD5).
- An UDP datagram is **silently discarded** if checksum is in error.
  - No error message is generated
- Lots of UDP traffic is only sent locally
  - thus the reliability is comparable to the error rate on the local links. (see Stevens, Vol. 1, figure 11.5, pg. 147 for comparison of Ethernet, IP, UDP, and TCP checksum errors)
- Each output operation results in **one UDP datagram**, which causes **one IP datagram** to be sent
- Applications which use UDP: DNS, TFTP, BOOTP, DHCP, SNMP, NFS, VoIP, etc.
  - An advantage of UDP is that it is a base to build your own protocols on
  - Especially if you don't need reliability and in order delivery of lots of data

# UDP Header

8 byte header + possible data

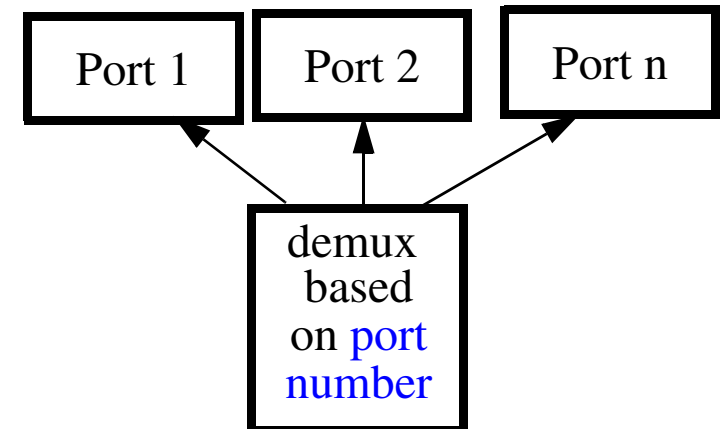
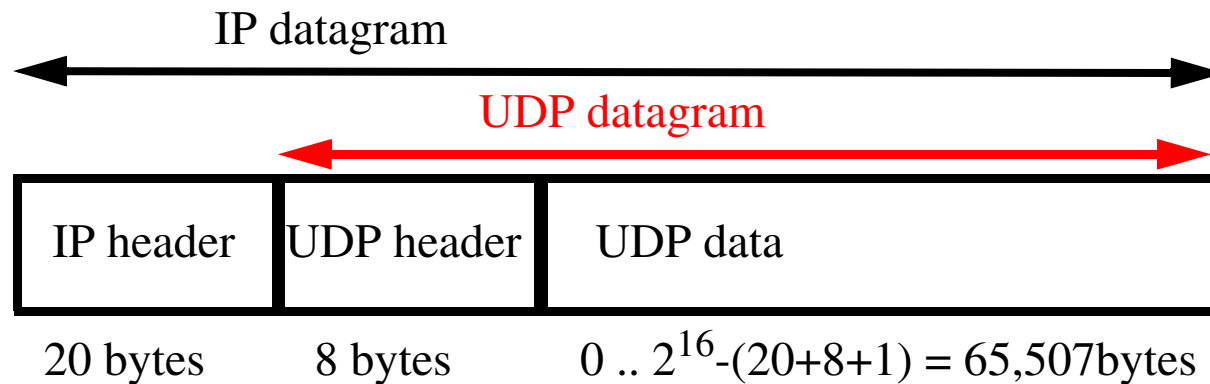
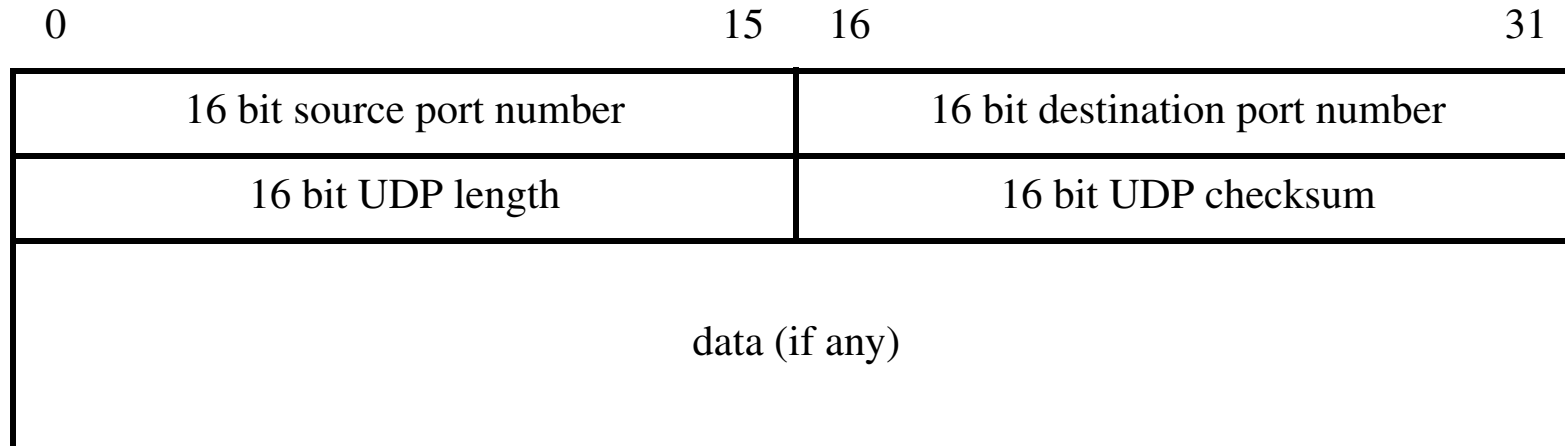

# UDP Checksum and Pseudo-Header

- UDP checksum covers more info than is present in the UDP datagram alone: **pseudo-header** and **pad byte (0)** {to even number of 16 bit words}.
- Propose: to verify the UDP datagram reached its correct destination: **right port number at the right IP address**.
- Pseudo-header and pad byte are **not transmitted** with the UDP datagram, only used for checksum computation.

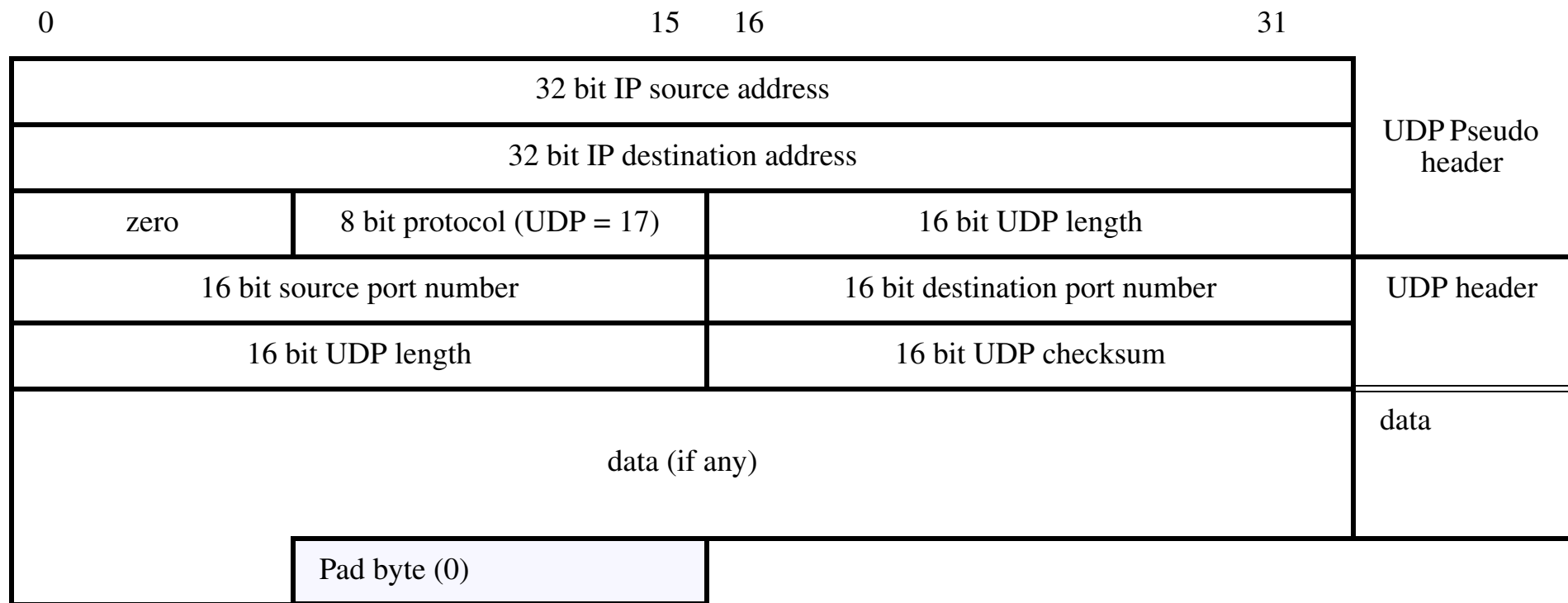

# Reserved and Available UDP Port Numbers

|                       | keyword     | UNIX keyword | Description                              |
|-----------------------|-------------|--------------|--|
| 0                     |             |              | reserved                                 |
| 7                     | ECHO        | echo         | Echo                                     |
| 9                     | DISCARD     | discard      | Discard == sink null                     |
| 11                    | USERS       | systat       | Active users                             |
| 13                    | DAYTIME     | daytime      | Daytime                                  |
| 15                    | -           | netstat      | Network status program                   |
| 17                    | QUOTE       | qotd         | Quote of the day                         |
| 19                    | CHARGEN     | chargen      | Character generator                      |
| 37                    | TIME        | time         | Time server                              |
| 39                    | RLP         | rlp          | Resource Location Protocol               |
| 42                    | NAMESERVER  | name         | Host Name Server                         |
| 43                    | NICNAME     | whois        | Who is                                   |
| 53                    | DOMAIN      | domain       | Domain Name Server                       |
| 67                    | BOOTPS      | bootps       | Bootstrap Protocol Server                |
| 68                    | BOOTPC      | bootpc       | Bootstrap Protocol Client                |
| 69                    | TFTP        | tftp         | Trivial File Transfer Protocol           |
| 88                    | KERBEROS    | kerberos5    | Kerberos v5 kdc                          |
| 111                   | SUNRPC      | sunrpc       | SUN Remote Procedure Call (portmap)      |
| 123                   | NTP         | ntp          | Network Time Protocol                    |
| 137                   | netbios_ns  | netbios_ns   | NetBIOS name service                     |
| 138                   | netbios_dgm | netbios_dgm  | NetBIOS Datagram Service                 |
| 139                   | netbios_ssn | netbios_ssn  | NetBIOS Session Service                  |
| 161                   |             | snmp         | Simple Network Management Protocol Agent |
| 162                   |             | snmp-trap    | Simple Network Management Protocol Traps |
| 512                   |             | biff         | mail notification                        |
| 513                   |             | who          | remote who and uptime                    |
| 514                   |             | syslog       | remote system logging                    |
| 517                   |             | talk         | conversation                             |
| 518                   |             | ntalk        | new talk, conversation                   |
| 520                   |             | route        | routing information protocol             |
| 525                   |             | timed        | remote clock synchronization             |
| 533                   | netwall     | netwall      | Emergency broadcasting                   |
| 750                   | kerberos    | kerberos     | Kerberos (server)                        |
| 6000 + display number |             |              | X11 server                               |
| 7000                  |             |              | X11 font server                          |



# Port numbers in three groups

| Range          | Purpose                                |
|----------------|--|
| 0 .. 1023      | System (Well-Known) Ports <sup>a</sup> |
| 1024 .. 49151  | User (Registered) Ports                |
| 49152 .. 65535 | Dynamic and/or Private Ports           |

a. Roughly 300 well know port numbers remain unassigned and 38 reserved  
Roughly 26k registered port numbers remain unassigned and 9 reserved

‘For the purpose of providing services to **unknown** callers, a service contact port is defined. This list specifies the port used by the server process as its contact port. The contact port is sometimes called the "well-known port".’

<http://www.iana.org/assignments/port-numbers>

Linux chooses the local port to use for TCP and UDP traffic from this range:

```
$ cat /proc/sys/net/ipv4/ip_local_port_range
1024      29999
```

# MTU and Datagram Fragmentation

If datagram size > MTU, perform fragmentation.

- At sending host or at intermediate router (IPv4).
- Reassembled only at final destination.

Example: 1501 (20 + 8 + 1473 data) on Ethernet (MTU=1500):

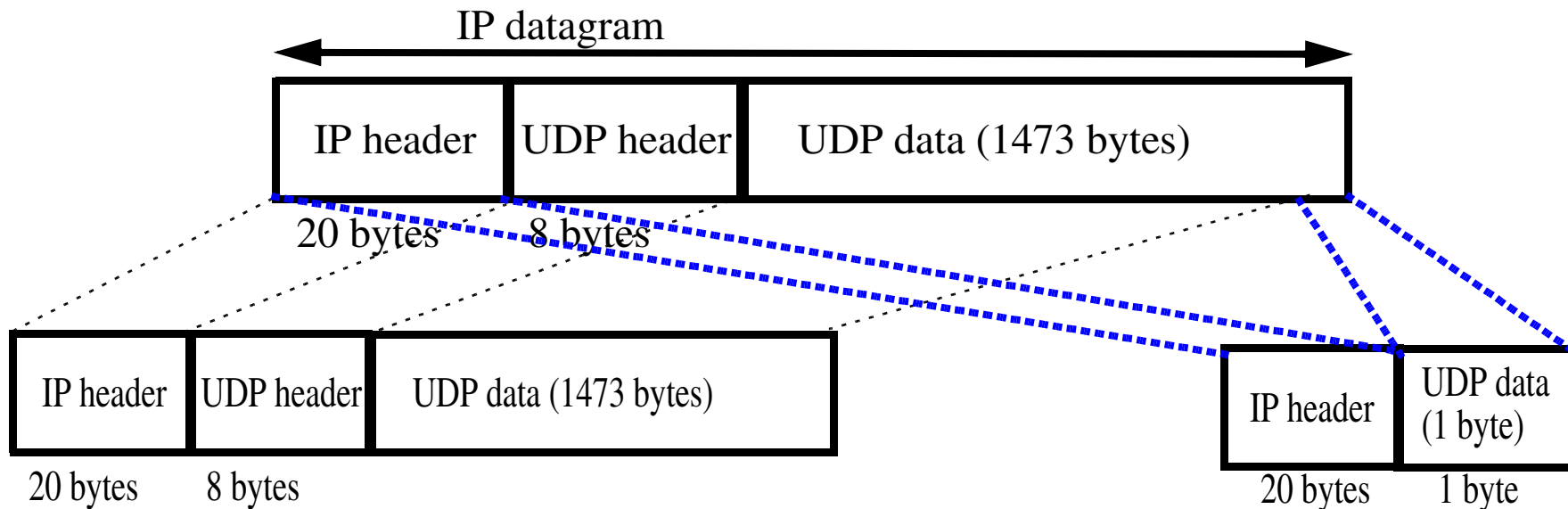

- Note there is no UDP header in the second fragment.
- Therefore, a frequent operation is to compute the path MTU before sending anything else. (see RFC 1191 for the table of common MTUs)

# Fragmentation Required

If datagram size  $>$  MTU, DF (Don't Fragment) in IP header is on, then the router sends ICMP Unreachable Error.

Of course this can be used to find Path MTU.

# Interaction between UDP and ARP

With ARP cache empty, send a UDP datagram with 8192 bytes onto an Ethernet

- 8192 bytes > ethernet MTU, therefore 6 fragments are created by IP
- if ARP cache is empty, first fragment causes ARP request to be sent
- This leads to two timing questions:

1. Are the remaining fragments sent before the ARP reply is received?
2. What does ARP do with multiple packets to the same destination while waiting for a reply?

## Example under BSD

```
Bsdi% arp -a          ARP cache is empty
Bsdi% sock -u -i -n1 -w8192 svr4 discard
10.0                  arp who-has svr4 tell bsdi
20.001234 (0.0012)    arp who-has svr4 tell bsdi
30.001941 (0.0007)    arp who-has svr4 tell bsdi
40.002775 (0.0008)    arp who-has svr4 tell bsdi
50.003495 (0.0007)    arp who-has svr4 tell bsdi
60.004319 (0.0008)    arp who-has svr4 tell bsdi
70.008772 (0.0045)    arp reply svr4 is-at 0:0:c0:c2:9b:26
80.009911 (0.0011)    arp reply svr4 is-at 0:0:c0:c2:9b:26
90.011127 (0.0012)    bsdi > svr4: (frag 10863:800@7400)
100.011255 (0.0001)   arp reply svr4 is-at 0:0:c0:c2:9b:26
110.012562 (0.0013)   arp reply svr4 is-at 0:0:c0:c2:9b:26
120.013458 (0.0009)   arp reply svr4 is-at 0:0:c0:c2:9b:26
130.014526 (0.0011)   arp reply svr4 is-at 0:0:c0:c2:9b:26
140.015583 (0.0011)   arp reply svr4 is-at 0:0:c0:c2:9b:26
```

- on a BSDI system:
  - each of the additional (5) fragments caused an ARP request to be generated
    - this **violates** the Host Requirements RFC - which tries to prevent **ARP flooding** by limiting the maximum rate to 1 per second
  - when the ARP reply is received the **last** fragment is sent
    - Host Requirements RFC says that ARP should save at least one packet and this should be the latest packet
  - unexplained anomaly: the System Vr4 system sent 7 ARP replies back!
  - no ICMP “time exceeded during reassembly” message is sent
    - BSD derived systems - never generate this error!  
It does set the timer internally and discard the fragments, but never sends an ICMP error.
    - fragment 0 (which contains the UDP header) was not received - so there is no way to know which process sent the fragment; thus unless fragment 0 is received - you are not required to send an ICMP “time exceeded during reassembly” error.

**Not just a fluke** (i.e., a rare event)

- The same error occurs even if you don’t have fragmentation - simply sending multiple UDP datagrams **rapidly** when there is no ARP entry is sufficient!
- NFS sends UDP datagrams whose length just exceeds 8192 bytes
  - NFS will timeout and resend
  - however, there will always be this behavior - if the ARP cache has no entry for this destination!

# Still a problem?

A UDP with 8192 payload to echo port as seen on SuSE 9.2 linux 2.6.8-24:

| No. | Time     | Source       | Destination  | Protocol | Info  |
|-----|----------|--------------|--------------|----------|---|
| 37  | 3.020002 | 172.16.33.16 | Broadcast    | ARP      | Who has 172.16.33.5? Tell 172.16.33.16            |
| 38  | 3.021385 | 172.16.33.5  | 172.16.33.16 | ARP      | 172.16.33.5 is at 00:40:8c:24:37:f4               |
| 39  | 3.021422 | 172.16.33.16 | 172.16.33.5  | IP       | Fragmented IP protocol (proto=UDP 0x11, off=4440) |
| 40  | 3.021452 | 172.16.33.16 | 172.16.33.5  | IP       | Fragmented IP protocol (proto=UDP 0x11, off=5920) |
| 41  | 3.021480 | 172.16.33.16 | 172.16.33.5  | IP       | Fragmented IP protocol (proto=UDP 0x11, off=7400) |

$3.021385 - 3.020002 = .001383$  sec.  $\Rightarrow$  1.383ms for the ARP reply

All but the last 3 fragments are dropped! Including the initial echo request packet -- so in the fragments that do arrive you don't know who they are for -- because the first fragment was lost!

# With an even larger UDP packet

I removed the arp cache entry with: `/sbin/arp -i eth1 -d 172.16.33.5`

When sending 65500 bytes of UDP payload -- it loses many packets (in fact all but the last 3 fragments)!!!

| No. | Time     | Source       | Destination  | Protocol | Info   |
|-----|----------|--------------|--------------|----------|--|
| 36  | 4.342158 | 172.16.33.16 | Broadcast    | ARP      | Who has 172.16.33.5? Tell 172.16.33.16             |
| 37  | 4.342875 | 172.16.33.5  | 172.16.33.16 | ARP      | 172.16.33.5 is at 00:40:8c:24:37:f4                |
| 38  | 4.342906 | 172.16.33.16 | 172.16.33.5  | IP       | Fragmented IP protocol (proto=UDP 0x11, off=62160) |
| 39  | 4.342932 | 172.16.33.16 | 172.16.33.5  | IP       | Fragmented IP protocol (proto=UDP 0x11, off=63640) |
| 40  | 4.342986 | 172.16.33.16 | 172.16.33.5  | IP       | Fragmented IP protocol (proto=UDP 0x11, off=65120) |

With the entry in the ARP cache get:

| No. | Time     | Source       | Destination | Protocol | Info   |
|-----|----------|--------------|-------------|----------|--|
| 35  | 5.118063 | 172.16.33.16 | 172.16.33.5 | IP       | Fragmented IP protocol (proto=UDP 0x11, off=1480)  |
| 36  | 5.118095 | 172.16.33.16 | 172.16.33.5 | IP       | Fragmented IP protocol (proto=UDP 0x11, off=2960)  |
| 37  | 5.118115 | 172.16.33.16 | 172.16.33.5 | IP       | Fragmented IP protocol (proto=UDP 0x11, off=4440)  |
| 38  | 5.118214 | 172.16.33.16 | 172.16.33.5 | IP       | Fragmented IP protocol (proto=UDP 0x11, off=5920)  |
| 39  | 5.118328 | 172.16.33.16 | 172.16.33.5 | IP       | Fragmented IP protocol (proto=UDP 0x11, off=7400)  |
| 40  | 5.118450 | 172.16.33.16 | 172.16.33.5 | IP       | Fragmented IP protocol (proto=UDP 0x11, off=8880)  |
| 41  | 5.118574 | 172.16.33.16 | 172.16.33.5 | IP       | Fragmented IP protocol (proto=UDP 0x11, off=10360) |
| 42  | 5.118695 | 172.16.33.16 | 172.16.33.5 | IP       | Fragmented IP protocol (proto=UDP 0x11, off=11840) |
| 43  | 5.118819 | 172.16.33.16 | 172.16.33.5 | IP       | Fragmented IP protocol (proto=UDP 0x11, off=13320) |
|     | ...      |              |             |          |  |
| 72  | 5.122385 | 172.16.33.16 | 172.16.33.5 | IP       | Fragmented IP protocol (proto=UDP 0x11, off=56240) |
| 73  | 5.122508 | 172.16.33.16 | 172.16.33.5 | IP       | Fragmented IP protocol (proto=UDP 0x11, off=57720) |
| 74  | 5.122631 | 172.16.33.16 | 172.16.33.5 | IP       | Fragmented IP protocol (proto=UDP 0x11, off=59200) |
| 75  | 5.122787 | 172.16.33.16 | 172.16.33.5 | IP       | Fragmented IP protocol (proto=UDP 0x11, off=60680) |
| 76  | 5.122877 | 172.16.33.16 | 172.16.33.5 | IP       | Fragmented IP protocol (proto=UDP 0x11, off=62160) |
| 77  | 5.122999 | 172.16.33.16 | 172.16.33.5 | IP       | Fragmented IP protocol (proto=UDP 0x11, off=63640) |
| 78  | 5.123122 | 172.16.33.16 | 172.16.33.5 | IP       | Fragmented IP protocol (proto=UDP 0x11, off=65120) |

The initial UDP Echo request is still lost! The key parameter is

`/proc/sys/net/ipv4/neigh/ethX/unres_qlen` where X is the interface (i.e., eth0, eth1, ...) -- the default value is 3.

# Maximum UDP Datagram size

- theoretical limit: 65,535 bytes - due to (IP's) 16-bit total length field
  - with 20 bytes of IP header + 8 bytes of UDP header  $\Rightarrow$  65,507 bytes of user data
- two limits:
  - sockets API limites size of send and receive buffer; generally 8 kbytes, but you can call a routine to change this
  - TCP/IP implementation - Stevens found various limits to the sizes - even with loopback interface (see Stevens, Vol. 1, pg. 159)
- Hosts are required to handle at least 576 byte IP datagrams, thus lots of protocols limit themselves to 512 bytes or less of data:
  - DNS, TFTP, BOOTP, and SNMP



# Datagram truncation

What if the application is not prepared to read the datagram of the size sent?

Implementation dependent:

- traditional Berkeley: silently truncate
- 4.3BSD and Reno: **can** notify the application that the data was truncated
- SVR4: excess data returned in subsequent reads - application is not told that this all comes from one datagram
- TLI: sets a flag that more data is available, subsequent reads return the rest of the datagram

# Socket API

- `int socket(int domain, int type, int protocol);`
  - creates an endpoint description that you can use to send and receive network traffic
- `int bind(int sockfd, struct sockaddr *my_addr, socklen_t addrlen);`
  - binds a socket to the local address and port: `my_address`
- `int connect(int sockfd, const struct sockaddr *serv_addr, socklen_t addrlen);`
  - connect the local socket to a remote socket
- `int listen(int s, int backlog);`
  - indicates that socket is willing to accept connections & limits the queue of pending connections
- `int accept(int s, struct sockaddr *addr, socklen_t *addrlen);`
  - accepted the first connection request from the queue and connects it to the socket
- connection oriented sending and receiving:
  - `ssize_t send(int s, const void *buf, size_t len, int flags);`
  - `ssize_t recv(int s, void *buf, size_t len, int flags);`
- datagram sending and receiving:
  - `ssize_t sendto(int s, const void *buf, size_t len, int flags, const struct sockaddr *to, socklen_t tolen);`
  - `ssize_t recvfrom(int s, void *buf, size_t len, int flags, struct sockaddr *from, socklen_t *fromlen);`
- `int close(int fd)` and `int shutdown(int s, int how)` - end it all!

# Learning about Socket programming

For examples of using the socket API and networking programming see :

- Richard Stevens, *UNIX Network Programming, Volume 1, Second Edition: Networking APIs: Sockets and XTI*, Prentice Hall, 1998, ISBN 0-13-490012-X
  - source code <ftp://ftp.kohala.com/pub/rstevens/unpv12e.tar.gz>
  - errata list: <http://www.kohala.com/~rstevens/typos.unpv12e.txt>
- Brian "Beej" Hall, "Beej's Guide to Network Programming: Using Internet Sockets", 04/08/2004 07:22:02 PM

<http://www.ecst.csuchico.edu/~beej/guide/net/>

Two addition socket functions for controlling various properties of sockets are:

- int `getsockopt`(int s, int level, int optname, void \*optval, socklen\_t \*optlen);
- int `setsockopt`(int s, int level, int optname, const void \*optval, socklen\_t optlen);

For example, the options `SO_SNDBUF` and `SO_RCVBUF` - control the size of the sending buffer and the receiver buffer.

# Simple UDP client

```
#include <stdio.h>
#include <sys/types.h>
#include <sys/socket.h>
#include <netinet/in.h>
#define bigBufferSize      8192
#define destination_host  "172.16.33.5"

main(argc, argv)
int argc;
char **argv;
{ int client_socket_fd;          /* Socket to client, server */
  struct sockaddr_in server_addr; /* server's address */
  char bigBuffer[bigBufferSize]; /* buffer of data to send as payload */
  int sendto_flags=0;

                                  /* create a UDP socket */
  if ((client_socket_fd = socket(AF_INET, SOCK_DGRAM, IPPROTO_UDP)) == -1) {
    perror("Unable to open socket"); exit(1); }

                                  /* initialize the server address structure */
  memset( (char*)&server_addr, 0, sizeof(server_addr));
  server_addr.sin_family=AF_INET;
  server_addr.sin_port=htons(9); /* 9 is the UDP port number for Discard */

  if (inet_aton(destination_host, (struct sockaddr*)&server_addr.sin_addr) == 0) {
    fprintf(stderr, "could not get an address for: %s", destination_host);exit(1);}

  if ((sendto(client_socket_fd, bigBuffer, bigBufferSize,
              sendto_flags, (struct sockaddr*)&server_addr, sizeof(server_addr))) == -1) {
    perror("Unable to send to socket"); close(client_socket_fd); exit(1);}

  close(client_socket_fd);        /* close the socket */
  exit(0);
}
```

## UDP server design

Stevens, Vol, 1, pp. 162-167 discusses how to program a UDP server

You can often determine what IP address the request was sent to (i.e., the destination address):

- for example: thus ignoring datagrams sent to a broadcast address

You can limit a server to a given incoming IP address:

- thus limiting requests to a given interface

You can limit a server to a given foreign IP address and port:

- only accepting requests from a given foreign IP address and port #

Multiple recipients per port (for implementations with multicasting support)

- setting `SO_REUSEADDR` socket option  $\Rightarrow$  each process gets a copy of the incoming datagram

Note: limited size input queue to each UDP port, can result in silent discards without an ICMP message being sent back (since **OS discarded**, not the network!)

# UDP listener example

```
#include <stdio.h>
#include <sys/types.h>
#include <sys/socket.h>
#include <netinet/in.h>

#define bigBufferSize 8192
#define my_port      52000
#define destination_host "127.0.0.1"

main(argc, argv)
int argc;
char **argv;
{
    int client_socket_fd;          /* Socket to client, server */
    struct sockaddr_in client_addr; /* client's address */
    struct sockaddr_in other_addr; /* other party's address */
    int other_addr_len;
    char bigBuffer[bigBufferSize];
    int sendto_flags=0;

                                /* create a UDP socket */
    if ((client_socket_fd = socket(AF_INET, SOCK_DGRAM, IPPROTO_UDP)) == -1) {
        perror("Unable to open socket"); exit(1); }

    memset((char*)&client_addr, 0, sizeof(client_addr)); /* initialize address structure */
    client_addr.sin_family=AF_INET;
    client_addr.sin_port=htons(my_port);
    client_addr.sin_addr.s_addr = htonl(INADDR_ANY);

    if (bind(client_socket_fd, (struct sockaddr*)&client_addr, sizeof(client_addr))==-1) {
        close(client_socket_fd); exit(1); }

    if ((recvfrom(client_socket_fd, bigBuffer, bigBufferSize,
                  sendto_flags, (struct sockaddr*)&other_addr, &other_addr_len)) == -1) {
        perror("Unable to receive from socket"); close(client_socket_fd); exit(1); }

    printf("Received packet from %s:%d\nData: %s\nString length=%d\n",
           inet_ntoa(other_addr.sin_addr), ntohs(other_addr.sin_port), bigBuffer, strlen(bigBuffer));

    close(client_socket_fd); exit(0);}
```

# Changed the client

Changing the following:

```
#define destination_host "127.0.0.1"  
#define my_port          52000  
  
server_addr.sin_port=htons(my_port);
```

Adding some content to the bigBuffer:

```
sprintf(bigBuffer, "This is a simple test string to be sent to the  
other party\n");
```

Sending only as much of the buffer as necessary:

```
if ((sendto(client_socket_fd, bigBuffer, strlen(bigBuffer),  
            sendto_flags, (struct sockaddr*)&server_addr,  
            sizeof(server_addr))) == -1) {...}
```

Results in the listener outputting:

```
Received packet from 127.0.0.1:1260  
Data: This is a simple test string to be sent to the other party  
  
String length=59
```

# Building a UDP packet from scratch

```
/* simple example of building a UDP packet from scratch, based on the program:
   PingPong - 970621 by Willy TARREAU <tarreau@aemiaif.ibp.fr>
   http://www.insecure.org/sploits/inetd.internal_udp_ports.DOS.attack.html
   As this program uses RAW sockets, you must be root to run it
*/
```

```
#include <netinet/in.h>
#include <netinet/ip.h>
#include <netinet/udp.h>
#include <netdb.h>
#include <stdlib.h>
#include <string.h>
#include <stdio.h>
#include <ctype.h>
#include <errno.h>
```

```
struct sockaddr addrfrom;
struct sockaddr addrto;
int s;
u_char outpack[65536];
struct iphdr *ip;
struct udphdr *udp;
```

```
main(int argc, char **argv) {
    struct sockaddr_in *from;
    struct sockaddr_in *to;
    struct protoent *proto;
    int i;
    char *src,*dest;
    int srctp, destp;
    int packetsize,datasize;

    if (argc!=5) {fprintf(stderr,"Usage: %s src_addr src_port dst_addr dst_port\n", argv[0]);
                 fprintf(stderr,"src_addr and dst_addr must be given as IP addresses (xxx.xxx.xxx.xxx)\n");
                 exit(2);}
    src=argv[1]; srctp=atoi(argv[2]); dest=argv[3]; destp=atoi(argv[4]);
```



```

if (!(proto = getprotobyname("raw"))) {perror("getprotobyname(raw)");exit(2);}

if ((s = socket(AF_INET, SOCK_RAW, proto->p_proto)) < 0) {perror("socket");exit(2);}

memset(&addrfrom, 0, sizeof(struct sockaddr));
from = (struct sockaddr_in *)&addrfrom;
from->sin_family = AF_INET;
from->sin_port=htons(srcp);
if (!inet_aton(src, &from->sin_addr)) {fprintf(stderr,"Incorrect address for 'from': %s\n",src);exit(2); }

memset(&addrto, 0, sizeof(struct sockaddr));
to = (struct sockaddr_in *)&addrto;
to->sin_family = AF_INET;
to->sin_port=htons(destp);
if (!inet_aton(dest, &to->sin_addr)) {fprintf(stderr,"Incorrect address for 'to': %s\n",dest);exit(2); }

packetsize=0;

/* build a UDP packet from scratch */

ip=(struct iphdr *)outpack;
ip->version=4;          /* IPv4 */
ip->ihl=5;              /* IP header length: 5 words */
ip->tos=0;              /* no special type of service */
ip->id=0;               /* no ID */
ip->frag_off=0;        /* not a fragment - so there is no offset */
ip->ttl=0x40;          /* TTL = 64 */

if (!(proto = getprotobyname("udp"))) {perror("getprotobyname(udp)"); exit(2);}

ip->protocol=proto->p_proto;
ip->check=0;           /* null checksum, will be automatically computed by the kernel */
ip->saddr=from->sin_addr.s_addr; /* set source and destination addresses */
ip->daddr=to->sin_addr.s_addr;
/* end of ip header */

```

```

packetsize+=ip->ihl<<2;
/* udp header */
udp=(struct udphdr *)((int)outpack + (int)(ip->ihl<<2));
udp->source=htons(srcp);
udp->dest=htons(destp);
udp->check=0; /* ignore UDP checksum */
packetsize+=sizeof(struct udphdr);
/* end of udp header */

/* add data to UDP payload if you want: */
for (datasize=0;datasize<8;datasize++) {
    outpack[packetsize+datasize]='A'+datasize;
}
packetsize+=datasize;
udp->len=htons(sizeof(struct udphdr)+datasize);
ip->tot_len=htons(packetsize);

if (sendto(s, (char *)outpack, packetsize, 0, &addrto, sizeof(struct sockaddr))==-1)
    {perror("sendto"); exit(2);}

printf("packet sent !\n");
close(s);
exit(0);
}

```

## ICMP Source Quench Error

Since UDP has **no flow control**, a node could receive datagrams faster than it can process them. In this situation the host **may** send an ICMP source quench.

Note: “**may** be generated” - it is not required to generate this error

Stevens (Vol. 1, pp. 160-161) gives the example of sending 100 1024-byte datagrams from a machine on an ethernet via a router and SLIP line to another machine:

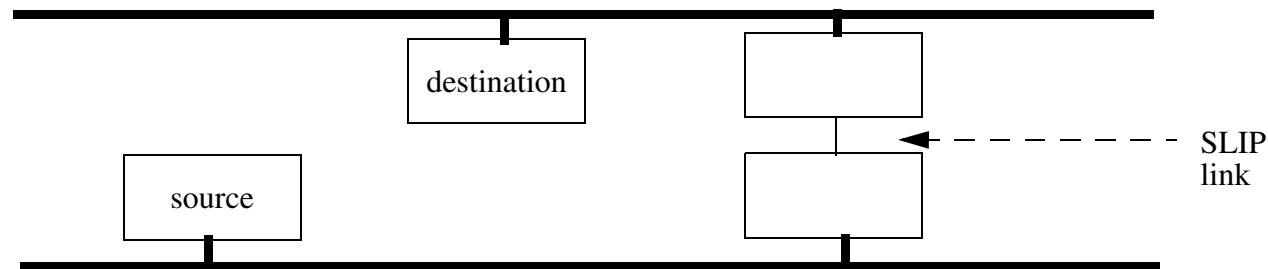

Figure 1: simplified from Stevens, Vol. 1, inside cover

- SLIP link is ~1000 times slower than the ethernet
- 26 datagrams are transmitted, then a source quench is sent for each successive datagram

- the router gets all 100 packets, before the first has been sent across the link!
  - the new Router Requirements RFC - says that routers should not generate source quench errors, since it just consumes network bandwidth and it is an ineffective and unfair fix for congestion
- In any case, the sending program never responded to the source quench errors!
  - BSD implementations ignore received source quenches if the protocol is UDP
  - the program finished before the source quench was received!

Thus if you want reliability you have to build it in and do end-to-end flow control, error checking, and use (and thus wait for) acknowledgements.

# No error control

Since UDP has no error control, the sender has to take responsibility for sending the datagram again if this datagram must be delivered.

But how does the sender know if a datagram was successfully delivered?

- Unless the receiver sends a reply (or does some action due to receiving a given datagram) the sender will **not** know! [loss]
- Note that without some additional mechanism - the sender doesn't know if the datagram was delivered multiple times! [duplicates]

If you want reliability you have to build your own protocol on top of UDP to achieve it. This includes deciding on your own retransmission scheme, timeouts, etc.

# BOOTP: Bootstrap Protocol (RFC 951)

Although you can figure out who you are, i.e., your IP address, via RARP - many machines want more information.

BOOTP requests and answer are sent via UDP (port 67 server; port 68 client)

- so it is easy to make a user space server
- the client (who wants the answer) need not have a full TCP/IP, it can simply send what **looks** like a UDP datagram with a BOOTP request<sup>1</sup>.

|   |                               |   |           |
|---|-------------------------------|---|-----------|
| Opcode (1=request,<br>2=reply)              | hardware type<br>(1=ethernet) | hardware address length<br>(6 for ethernet) | hop count |
| transaction ID                              |                               |   |           |
| number of seconds                           |                               | unused                                      |           |
| client IP address                           |                               |   |           |
| your IP address                             |                               |   |           |
| server IP address                           |                               |   |           |
| gateway IP address                          |                               |   |           |
| client hardware address (16 bytes of space) |                               |   |           |
| server hostname (64 bytes)                  |                               |   |           |
| Boot file name (128 bytes)                  |                               |   |           |
| Vendor specific information (64 bytes)      |                               |   |           |

1. see Stevens, Vol. 1, figure 16.2, pg. 216

# BOOTP continued

When a request is sent as an IP datagram:

- if client does not know its IP address it uses 0.0.0.0
- if it does not know the server's address it uses 255.255.255.255
- if the client does not get a reply, it tries again in about 2 sec.

# Vendor specific information (RFC 1497 and RFC1533)

- if this area is used the first 4 bytes are: IP address 99.130.83.99 this is called the “**magic cookie**”
- the rest of the area is a list of items, possibly including:
  - Pad (tag=0);
  - Subnet mask (tag=1);
  - Time offset (tag=2);
  - List of IP addresses of Gateways (tag=3);
  - Time server's IP address (tag=4);
  - Name Server (tag=5);
  - Domain Name Server (tag=6);
  - LOG server (tag=7); ...
  - LPR server (tag=9); ...
  - this Host's name (tag=12);
  - Boot file size (tag=13); ...
  - Domain name (tag=15); ...
  - End (tag=255)



# DHCP: Dynamic Host Configuration Protocol (RFC 1531)

Extends the Vendor specific options area by 312 bytes.

This protocol is designed to make it easier to allocate (and reallocate) addresses for clients. DHCP defines:

- Requested IP Address - used in client request (DHCPDISCOVER) to request that a particular IP address (tag=50)
- IP Address Lease Time - used in a client request (DHCPDISCOVER or DHCPREQUEST) to request a lease time for the IP address. In a server reply (DHCPOFFER), specific lease time offered. (tag=51)
- Option Overload - used to indicate that the DHCP “sname” or “file” fields are being overloaded by using them to carry DHCP options. A DHCP server inserts this option if the returned parameters will exceed the usual space allotted for options, i.e., it uses the sname and file fields for another purpose! (tag=52)

- DHCP Message Type - the type of the DHCP message (tag=53)

| Message Type | purpose      |
|--------------|--------------|
| 1            | DHCPDISCOVER |
| 2            | DHCPOFFER    |
| 3            | DHCPREQUEST  |
| 4            | DHCPDECLINE  |
| 5            | DHCPACK      |
| 6            | DHCPNAK      |
| 7            | DHCPRELEASE  |

- Server Identifier - used in DHCPOFFER and DHCPREQUEST (optionally in DHCPACK and DHCPNAK) messages. Servers include this in the DHCPOFFER to allow the client to distinguish between lease offers. DHCP clients indicate which of several lease offers is being accepted by including this in a DHCPREQUEST message. (tag=54)
- Parameter Request List - used by a DHCP client to request values for specified configuration parameters. The client **may** list options in order of preference. The DHCP server **must** try to insert the requested options in the order requested by the client. (tag=55)

- Message - used by a server to provide an error message to client in a DHCPNAK message in the event of a failure. A client may use this in a DHCPDECLINE message to indicate the reason **why** the client declined the offered parameters.(tag=56)
- Maximum DHCP Message Size - specifies the maximum length DHCP message that it is willing to accept. A client may use the maximum DHCP message size option in DHCPDISCOVER or DHCPREQUEST messages, but should not use the option in DHCPDECLINE messages. (tag=57)
- Renewal (T1) Time Value - specifies the time interval from address assignment until the client transitions to the RENEWING state. (tag=58)
- Rebinding (T2) Time Value - specifies the time interval from address assignment until the client transitions to the REBINDING state.(tag=59)
- Class-identifier - used by DHCP clients to optionally identify the type and configuration of a DHCP client. Vendors and sites may choose to define specific class identifiers to convey particular configuration or

other identification information about a client. Servers not equipped to interpret the class-specific information sent by a client **must** ignore it (although it may be reported). (tag=60)

- Client-identifier - used by DHCP clients to specify their unique identifier. DHCP servers use this value to index their database of address bindings. This value is expected to be unique for all clients in an administrative domain. (tag=61)

# DHCP's importance

- allows reuse of address, which avoids having to tie up addresses for systems which are not currently connected to the Internet
- avoids user configuration of IP address (avoids mistakes and effort)
- allows recycling of an IP address when devices are scrapped
- ...

## How big a problem is manual configuration?

A large site (such as DuPont Co. - a large chemical company) has over 65,000 IP addressable devices; or consider what happens if each of the 815,000 Wal-Mart employees has an IP device

Address management software

| Product            | Vendor              | URL   |
|--------------------|---------------------|---|
| Network Registrar  | Cisco               | <a href="http://www.cisco.com">http://www.cisco.com</a>                         |
| NetID              | Nortel Networks     | <a href="http://www.nortelnetworks.com">http://www.nortelnetworks.com</a>       |
| Meta IP 4.1        | CheckPoint          | <a href="http://www.metaip.checkpoint.com">http://www.metaip.checkpoint.com</a> |
| QIP Enterprise 5.0 | Lucent Technologies | <a href="http://qip.lucent.com">http://qip.lucent.com</a>                       |

# DHCP performance problems

Most implementations of DHCP do a duplicate address detection (DAAD) test **after** they have picked an address to assign.

An alternative approach to speed up the DHCP process does the duplicate address detection process in the background (in advance) so that you will have a set of recently tested addresses to hand out:

Jon-Olov Vatn and Gerald Q. Maguire Jr., "The effect of using co-located care-of addresses on macro handover latency", Fourteenth Nordic Tele-traffic Seminar (NTS 14), August 18 - 20, 1998, Lyngby, Denmark.

<http://www.it.kth.se/~vatn/research/nts14-coloc.pdf>

The result is that a DHCP request can be answered in less than 100ms.

# Example of dhcpd.conf

```
### Managed by Linuxconf, you may edit by hand.
### Comments may not be fully preserved by linuxconf.
server-identifier dhcptest1;
default-lease-time 1000;
max-lease-time 2000;
option domain-name          "3ctechnologies.se";
option domain-name-servers  130.237.12.2;
option host-name             "s1.3ctechnologies.se";
option routers               130.237.12.2;
option subnet-mask           255.255.255.0;
subnet 130.237.12.0 netmask 255.255.255.0 {
    range 130.237.12.3 130.237.12.200;
    default-lease-time 1000;
    max-lease-time 2000;
}
subnet 130.237.11.0 netmask 255.255.255.0 {
    range 130.237.11.3 130.237.11.254;
    default-lease-time 1000;
    max-lease-time 2000;
}
```

# DHCP and DNS

- There is no dynamic host name assignment yet.
- Interaction between DHCP and DNS is needed.

For example: once a host is assigned an IP address the DNS should be updated dynamically:

- If the host hasn't got a name: it should assign a name along the IP address assignment (no DNS update is needed).
- If the host has already a name: the DNS should be dynamically updated once the host has gotten a new IP address from DHCP.

The IETF's Dynamic Host Configuration (dhc) Working group

<http://www.ietf.org/html.charters/dhc-charter.html> is working on addressing the issues concerning interaction between DHCP and DNS.



# Trivial File Transfer Protocol (TFTP)

TFTP uses UDP (unlike FTP which uses TCP)

- simple and small
- requires only UDP, IP, and a device driver - easily fits in ROM
- a stop-and-wait protocol
- lost packets detected by timeout and retransmission
- Two operations:
  - Read Request (RRQ)
  - Write Request (RRQ) - for security reasons the file must already exist
- The TFTP server (“tftpd”) is generally run setrooted (i.e., it only has access to its own directory) and with a special **user** and **group** ID - since there is no password or other protection of the access to files via TFTP!
- TFTP request is sent to the well known port number (69/udp)
- TFTP server uses an unused ephemeral port for its replies
  - since a TFTP transfer can last for quite some time - it uses another port; thus freeing up the well known port for other requests

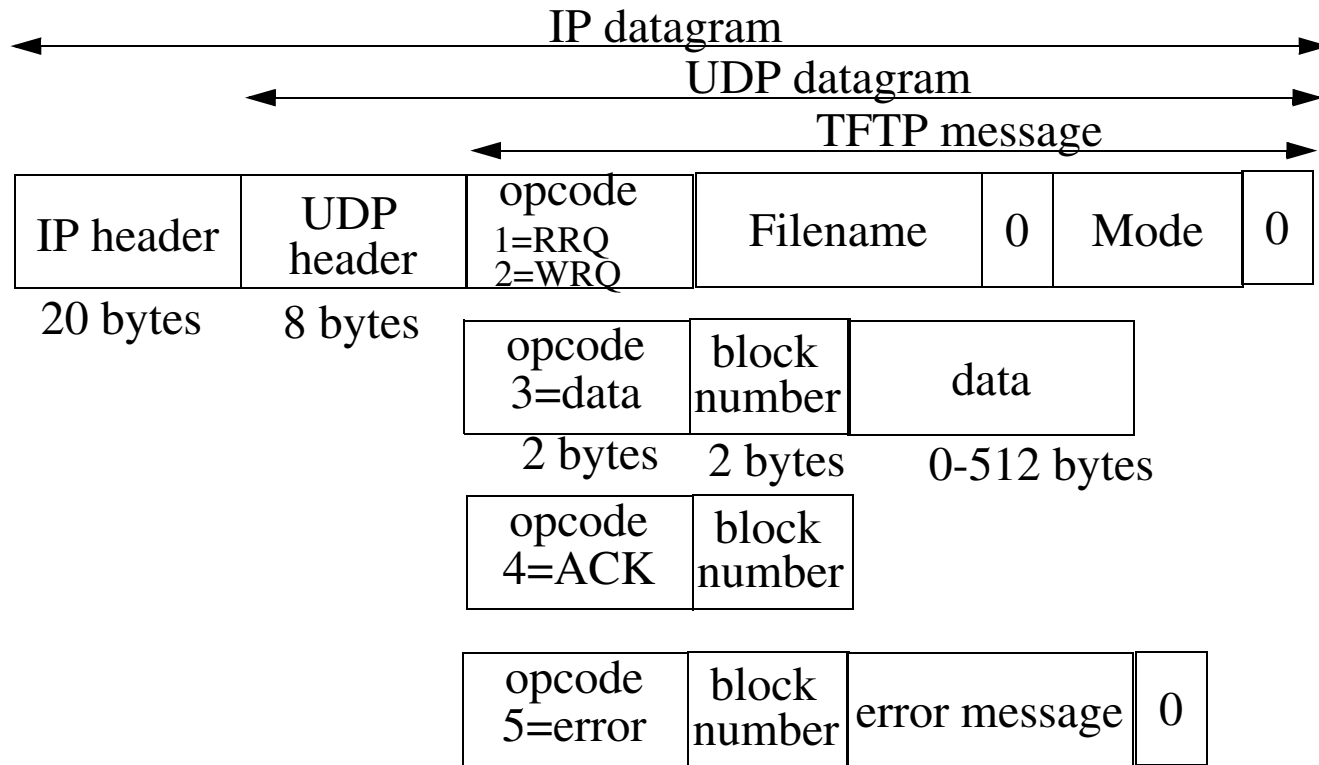

Figure 2: TFTP messages (see Stevens, Vol. 1, figure 15.1, pg. 210)

Filename and Mode (“netascii” or “octet”) are both N bytes sequences terminated by a null byte.

Widely used for bootstrapping diskless systems (such as X terminals) and for dumping the configuration of routers (this is where the write request is used)

# Mapping names to IP addresses

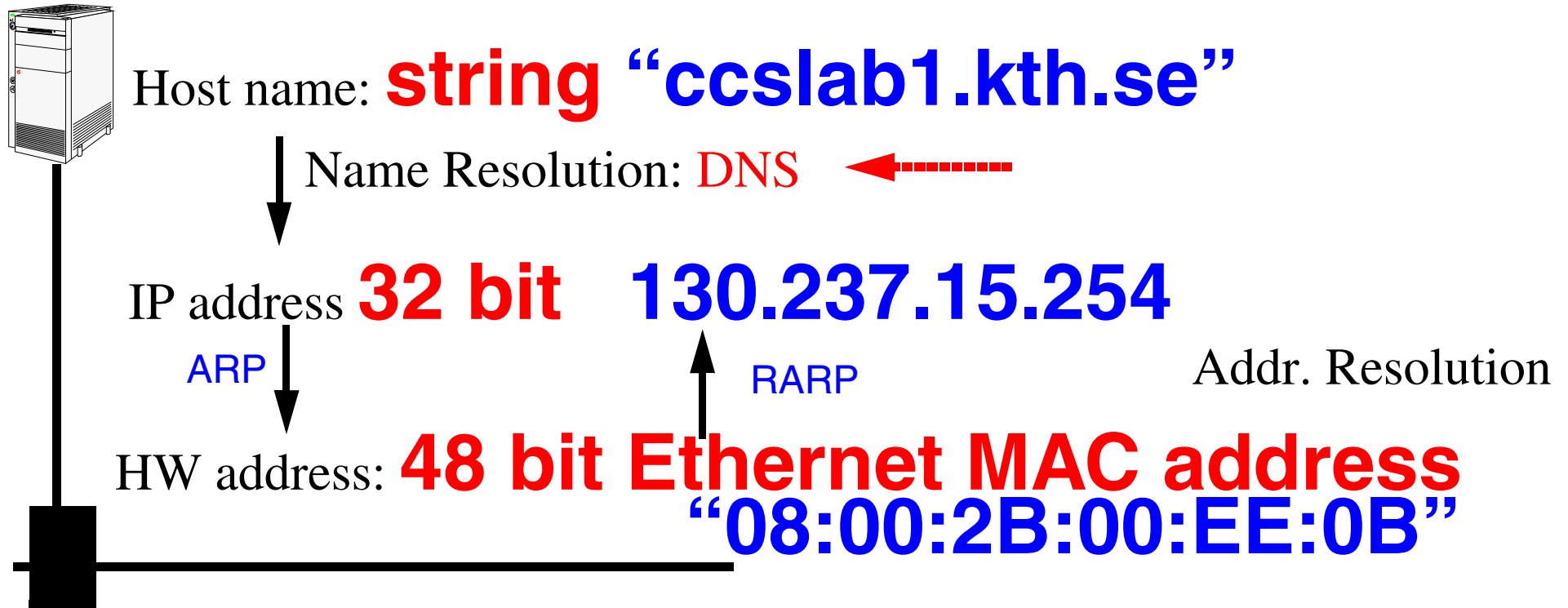

Figure 3: mapping between host names and IP address(es)

# DNS: Domain Name Service (RFC 1034, RFC 1035)

- To make the network more user friendly
- Distributed database (with **caching**) providing:
  - hostname  $\Rightarrow$  IP address, IP address  $\Rightarrow$  hostname
  - mailbox  $\Rightarrow$  mail server
  - ...
- applications call a “resolver”
  - gethostbyname: hostname  $\Rightarrow$  IP address
  - gethostbyaddr: IP address  $\Rightarrow$  hostname
- Resolver’s contact name servers (see “/etc/resolv.conf”)
- DNS names:
  - domain name: list of labels from a root, i.e., www.imit.kth.se
  - Fully Qualified Name (FQDN): a domain name ending in “.” - there are no further labels
  - leaves are managed **locally** through delegation of authority (to a zone) **not** centrally; this allows scaling
  - if a name server does not know the answer it asks other name servers
    - every name server **must** know how to contact a **root server**
- Uses UDP (for query) and TCP (zone transfer and large record query)

# Zones

A zone is a subtree of the DNS tree which is managed separately.

Each zone must have multiple name servers:

- a **primary name server** for the zone
  - gets its data from disk files (or other stable store)
  - must know the IP address of one or more **root servers**
- one or more **secondary name servers** for the zone
  - get their data by doing a **zone transfer** from a primary
  - generally query their primary server every ~3 hours

To find a server you may have to walk the tree up to the root or possibly from the root down (but the later is **not friendly**).

# DNS Message format

0

16

31

|                                       |                      |
|---------------------------------------|----------------------|
| Identification                        | Parameters           |
| Number of Questions                   | Number of Answers    |
| Number of authority                   | Number of Additional |
| Question section<br>...               |                      |
| Answer section<br>...                 |                      |
| Additional Information section<br>... |                      |

| Bit or Parameter field | Meaning   |
|------------------------|---|
| 0                      | Operation: 0=Query, 1=Response  |
| 1-4                    | Query type: 0=standard, 1=Inverse   |
| 5                      | Set if answer is authoritative  |
| 6                      | Set if answer is truncate   |
| 7                      | Set if answer is desired  |
| 8                      | Set if answer is available  |
| 9-11                   | reserved  |
| 12-15                  | Response Type: 0=No error, 1=Format error in query, 2=Server failure, 3=Name does not exist |

# Internet's top level domains

(see Stevens, Vol. 1, figure 14.2, pg. 189)

| Domain | Description   |
|--------|---|
| com    | commercial organizations  |
| edu    | educational organizations   |
| gov    | other U.S. government organizations (see RFC 1811 for policies)               |
| int    | international organizations   |
| mil    | U.S. Military   |
| net    | networks  |
| org    | other organizations   |
| arpa   | special domain for address to name mappings, e.g., 5.215.237.130.in-addr.arpa |
| ae     | United Arab Emirates  |
| ...    |   |
| se     | Sweden  |
| zw     | Zimbabwe  |

## Lots of interest in having subdomains of “com”

- ◆ companies registering product names, etc. - in some cases asking for 10s of addresses
- ◆ who gets to use a given name? problems with registered trade marks, who registered the name first, ... [How much is a name worth?]

# New top level domains

There is a proposed new set of top level domains and an increase in the number of entities which can assign domain names.

Generic Top Level Domains (gTLDs), November 16, 2000:

|         |                                   |
|---------|-----------------------------------|
| .aero   | for the entire aviation community |
| .biz    | for business purpose              |
| .coop   | for cooperatives                  |
| .info   | unrestricted                      |
| .museum | for museums                       |
| .name   | for personal names                |
| .pro    | for professionals                 |

CORE (Council of Registrars) - operational organization composed of authorized Registrars for managing allocations under gTLDs.

WIPO provides arbitration concerning names:

<http://arbiter.wipo.int/domains/gtld/newgtld.html>



# Domain registrars

Internet Corporation for Assigned Names and Numbers (ICANN) Accredited Registrars, the full list is at <http://www.icann.org/registrars/accredited-list.html>

Even more registrars are on their way to being accredited and operating!

# Country Code Top-Level Domains (CCTLDs)

<http://www.iana.org/cctld/cctld-whois.htm>

For Sweden (SE) SE-DOM, the NIC is: <http://www.nic-se.se/>

|         | <b>Administrative contact</b>                                      | <b>Technical contact</b>   |
|---------|--|--|
| Address | II-Stiftelsen<br>Sehlstedtgatan 7<br>SE-115 28 Stockholm<br>Sweden | Network Information Centre Sweden<br>NIC-SE<br>Box 5774<br>SE-114 87 Stockholm<br>Sweden |
| e-mail  | ii-stiftelsen@iis.se   | hostmaster@nic-se.se   |
| phone   | +46 8 56849050   | +46 8 54585700   |
| fax     | +46 8 50618470   | +46 8 54585729   |

The above is from <http://www.iana.org/root-whois/se.htm>

URL for registration services: <http://www.iis.se/>

# Resource Records (RR)

See Stevens, Vol. 1, figure 14.2, pg. 201 (augmented with additional entires)

| Record type | Description  |
|-------------|--|
| A           | an IP address. Defined in RFC 1035   |
| AAAA        | an IPv6 address. Defined in RFC 1886   |
| PTR         | pointer record in the in-addr.arpa format. Defined in RFC 1035.                                  |
| CNAME       | canonical name≡ alias (in the format of a domain name). Defined in RFC 1035.                     |
| HINFO       | Host information. Defined in RFC 1035.   |
| MX          | Mail eXchange record. Defined in RFC 1035.   |
| NS          | authoritative Name Server (gives authoritative name server for this domain).Defined in RFC 1035. |
| TXT         | other attributes. Defined in RFC 1035.   |
| AFSDB       | AFS Data Base location. Defined in RFC 1183.   |
| ISDN        | ISDN. Defined in RFC 1183.   |
| KEY         | Public key. Defined in RFC 2065.   |
| KX          | Key Exchanger. Defined in RFC 2230.  |
| LOC         | Location. Defined in RFC 1876.   |
| MG          | mail group member. Defined in RFC 1035.  |
| MINFO       | mailbox or mail list information. Defined in RFC 1035.   |
| MR          | mail rename domain name. Defined in RFC 1035.  |
| NULL        | null RR. Defined in RFC 1035.  |
| NS          | Name Server. Defined in RFC 1035.  |

See Stevens, Vol. 1, figure 14.2, pg. 201 (augmented with additional entries)

| Record type | Description  |
|-------------|--|
| NSAP        | Network service access point address. Defined in RFC 1348. Redefined in RFC 1637. Redefined in RFC 1706. |
| NXT         | Next. Defined in RFC 2065.   |
| PX          | Pointer to X.400/RFC822 information. Defined in RFC 1664.  |
| RP          | Responsible Person. Defined in RFC 1183.   |
| RT          | Route Through. Defined in RFC 1183.  |
| SIG         | Cryptographic signature. Defined in RFC 2065.  |
| SOA         | Start Of Authority. Defined in RFC 1035.   |
| SRV         | Server. DNS Server resource record -- RFC 2052, for use with DDNS.                                       |
| TXT         | Text. Defined in RFC 1035.   |
| WKS         | Well-Known Service. Defined in RFC 1035.   |
| X25         | X25. Defined in RFC 1183.  |

Note that a number of the RR types above are for experimental use.

Name of an organization:

ISI.EDU. PTR 0.0.9.128.IN-ADDR.ARPA.

# Network names

Conventions:

- it.kth.se includes all the computers in the KTH/SU IT-University
- kth.se includes all the computers at KTH
- ...

As resource records:

```
> set querytype=any
```

```
> kth.se
```

```
...
```

```
Non-authoritative answer:
```

```
kth.se
```

```
kth.se
```

```
internet address = 130.237.72.201
```

```
origin = kth.se
```

```
mail addr = hostmaster.kth.se
```

```
serial = 2002011500
```

```
refresh = 3600 (1H)
```

```
retry = 600 (10M)
```

```
expire = 604800 (1W)
```

```
minimum ttl = 86400 (1D)
```

|        |                         |
|--------|-------------------------|
| kth.se | nameserver = kth.se     |
| kth.se | nameserver = nic.lth.se |
| kth.se | nameserver = ns.kth.se  |

Authoritative answers can be found from:

|            |                                |
|------------|--------------------------------|
| kth.se     | nameserver = kth.se            |
| kth.se     | nameserver = nic.lth.se        |
| kth.se     | nameserver = ns.kth.se         |
| kth.se     | internet address = 130.237.x.y |
| nic.lth.se | internet address = 130.235.z.w |
| ns.kth.se  | internet address = 130.237.m.n |

|                  |     |                         |
|------------------|-----|-------------------------|
| ARPANET.ARPA.    | PTR | 0.0.0.10.IN-ADDR.ARPA.  |
| isi-net.isi.edu. | PTR | 0.0.9.128.IN-ADDR.ARPA. |

# Example:

\$ORIGIN it.kth.se.

@

1D IN SOA

bbbb hostmaster (

2002012001

; serial

8H

; refresh

2H

; retry

2W

; expiry

8H )

; minimum

1D IN NS ns.ele.kth.se.  
1D IN NS ns.kth.se.  
1D IN MX 0 mail  
1D IN A 130.237.x.y  
1D IN AFSDB 1 xxxx  
1D IN AFSDB 1 yyyy  
1D IN AFSDB 1 zzzz

# MX information

```
> set querytype=MX
```

```
> kth.se
```

```
...
```

```
kth.se
```

```
preference = 0, mail exchanger = mail1.kth.se
```

```
kth.se
```

```
nameserver = kth.se
```

```
kth.se
```

```
nameserver = nic.lth.se
```

```
kth.se
```

```
nameserver = ns.kth.se
```

```
mail1.kth.se
```

```
internet address = 130.237.32.62
```

```
kth.se
```

```
internet address = 130.237.72.201
```

```
nic.lth.se
```

```
internet address = 130.235.20.3
```

```
ns.kth.se
```

```
internet address = 130.237.72.200
```

Another examine in MX RR format:

```
1D    IN MX    10 xxx.e.kth.se.
```

```
1D    IN MX    20 yyy.e.kth.se.
```



# Host names and info

How to give your host a name?

see RFC 1178: Choosing a Name for Your Computer

Internet Addresses: A second address for your host?

- to have multiple addresses for you computer, see section on “ifconfig”

## Hostinfo (HINFO)

```
> set querytype=HINFO
```

```
> kth.se
```

```
...
```

```
kth.se
```

```
CPU = sun-4/60
```

```
OS = unix
```

| Entry | owner | clas | TTL | RR type  | value         | comment      |
|-------|-------|------|-----|----------|---------------|--------------|
| xxxx  |       |      | 1D  | IN HINFO | "PC" "FLINUX" | ; "CPU" "OS" |
|       |       |      | 1D  | IN A     | 130.237.x.y   |              |

# Storing other attributes - TXT records

The general syntax is:

<owner> <class> <ttl> TXT “<attribute name>=<attribute value>”

Examples:

host.widgets.com IN TXT “printer=lpr5”

sam.widgets.com IN TXT “favorite drink=orange juice”

For more information see:

RFC 1464: *Using the Domain Name System To Store Arbitrary String Attributes*

# Configuring DNS

- Configuring the BIND resolver
  - `/etc/resolv.conf`
- Configuring the BIND nameserver (named)
  - `/etc/named.boot` or `/etc/named.conf`
- Configuring the nameserver database files (zone files)
  - `named.hosts` the zone file that maps hostnames to IP addresses
  - `named.rev` the zone file that maps IP addresses to hostnames

# Root servers

| ROOT-SERVERS.NET |                                   | IP address(es)                      | Home ASN | Location(s)  |
|------------------|-----------------------------------|-------------------------------------|----------|--|
| A                | Verisign Global Registry Services | 198.41.0.4                          | 19836    | Herndon, VA, US  |
| B                | EP.Net                            | 192.228.79.201<br>2001:478:65::53   |          | Marina del Rey, CA, US   |
| C                | Cogent Communications             | 192.33.4.12                         | 2149     | Herndon VA; Los Angeles;<br>New York City; Chicago   |
| D                | University of Maryland            | 128.8.10.90                         | 27       | College Park, MD, US   |
| E                | NASA Ames Research Centre         | 192.203.230.10                      | 297      | Mountain View, CA, US  |
| F                | Internet Systems Consortium (ISC) | 192.5.5.241<br>2001:500::1035       | 3557     | Ottawa; Palo Alto; San Jose CA; New York City; San Francisco; Madrid; Hong Kong; Los Angeles; Rome; Auckland; Sao Paulo; Beijing; Seoul; Moscow; Taipei; Dubai; Paris; Singapore; Brisbane; Toronto; Monterrey; Lisbon; Johannesburg; Tel Aviv; Jakarta; Munich; Osaka; Prague |
| G                | US Department of Defence          | 192.112.36.4                        | 568      | Vienna, VA, US   |
| H                | US Army Research Lab              | 128.63.2.53<br>2001:500:1::803f:235 | 13       | Aberdeen, MD, US   |
| I                | Autonomica/NORDUnet               | 192.36.148.17                       | 29216    | Stockholm; Helsinki; Milan; London; Geneva; Amsterdam; Oslo; Bangkok; Hong Kong; Brussels; Frankfurt; Ankara; Bucharest; Chicago; Washington DC; Tokyo; Kuala Lumpur; Palo Alto; Wellington  |
| J                | Verisign Global Registry Services | 192.58.128.30                       | 26415    | Herndon, VA, US  |
| K                | Reseaux IP Europeens (RIPE)       | 193.0.14.129<br>2001:7fd::1         | 25152    | London (UK); Amsterdam (NL); Frankfurt (DE); Athens (GR); Doha (QA); Milan (IT); Reykjavik (IS); Helsinki (FI); Geneva (CH); Poznan (PL); Budapest (HU)  |
| L                | IANA                              | 198.32.64.12                        | 20144    | Los Angeles, CA, US  |
| M                | WIDE Project                      | 202.12.27.33<br>2001:dc3::35        | 7500     | Tokyo; Seoul (KR); Paris (FR)  |

see <http://www.root-servers.org/>

# Load leveling [1]

For example, f.root-servers.net has a **single** IP address (192.5.5.241), but requests sent to 192.5.5.241 are routed to *different* nameservers

This routing can depend on:

- where the request is made from
- what the load on each of these names servers is

Note: this is transparent to the host which sent the request to F

ISC uses Hierarchical Anycast routing to do this, with some of the servers being:

- large, redundant, ... installations serving the *global* internet
- small installations serving a *local* region
- 28 nodes as of Feb. 2005

# F root nameserver nodes

|               | Site Code | Location      | IPv4/IPv6     | Node Type   |
|---------------|-----------|---------------|---------------|-------------|
| Asia Pacific  | AKL1      | Auckland      | IPv4          | Local Node  |
|               | BNE1      | Brisbane      | IPv4          | Local Node  |
|               | CGK1      | Jakarta       | IPv4          | Local Node  |
|               | HKG1      | Hong Kong     | IPv4          | Local Node  |
|               | KIX1      | Osaka         | IPv4 and IPv6 | Local Node  |
|               | PEK1      | Beijing       | IPv4          | Local Node  |
|               | SEL1      | Seoul         | IPv4 and IPv6 | Local Node  |
|               | TPE1      | Taipei        | IPv4          | Local Node  |
| Americas      | AKL1      | São Paulo     | IPv4          | Local Node  |
|               | LAX1      | Los Angeles   | IPv4 and IPv6 | Local Node  |
|               | LGA1      | New York      | IPv4 and IPv6 | Local Node  |
|               | MTY1      | Monterrey     | IPv4          | Local Node  |
|               | PAO1      | Palo Alto     | IPv4 and IPv6 | Global Node |
|               | SFO2      | San Francisco | IPv4 and IPv6 | Global Node |
|               | SQL1      | Redwood City  | IPv4 and IPv6 | Local Node  |
|               | SJC1      | San Jose      | IPv4          | Local Node  |
|               | YOW1      | Ottawa        | IPv4 and IPv6 | Local Node  |
|               | YYZ1      | Toronto       | IPv4          | Local Node  |
| Rest of World | CDG1      | Paris         | IPv4 and IPv6 | Local Node  |
|               | DXB1      | Dubai         | IPv4          | Local Node  |
|               | JNB1      | Johannesburg  | IPv4          | Local Node  |
|               | LIS1      | Lisbon        | IPv4 and IPv6 | Local Node  |
|               | MAD1      | Madrid        | IPv4          | Local Node  |
|               | MUC1      | Munich        | IPv4 and IPv6 | Local Node  |
|               | PRG1      | Prague        | IPv4          | Local Node  |
|               | ROM1      | Rome          | IPv4          | Local Node  |
|               | SVO1      | Moscow        | IPv4          | Local Node  |
|               | TLV1      | Tel Aviv      | IPv4          | Local Node  |

# Where is f.root-servers.net ?

traceroute to f.root-servers.net (192.5.5.241), 30 hops max, 40 byte packets

|    |   |        |        |        |
|----|---|--------|--------|--------|
| 1  | net212a.imit.kth.se (130.237.212.2)                 | 1 ms   | 1 ms   | 0 ms   |
| 2  | cn4-kf4-p2p.gw.kth.se (130.237.211.205)             | 1 ms   | 1 ms   | 1 ms   |
| 3  | ea4-cn4-p2p.gw.kth.se (130.237.211.102)             | 1 ms   | 1 ms   | 1 ms   |
| 4  | kth2-ea4-b.gw.kth.se (130.237.211.241)              | 1 ms   | 1 ms   | 1 ms   |
| 5  | stockholm4-SRP2.sunet.se (130.242.85.66)            | 1 ms   | 1 ms   | 1 ms   |
| 6  | 130.242.82.49 (130.242.82.49)                       | 1 ms   | 1 ms   | 1 ms   |
| 7  | se-kth.nordu.net (193.10.252.177)                   | 1 ms   | 2 ms   | 4 ms   |
| 8  | so-1-0.hsa2.Stockholm1.Level3.net (213.242.69.21)   | 4 ms   | 5 ms   | 4 ms   |
| 9  | so-4-1-0.mp2.Stockholm1.Level3.net (213.242.68.205) | 14 ms  | 8 ms   | 8 ms   |
| 10 | as-1-0.bbr2.London1.Level3.net (212.187.128.25)     | 36 ms  | 36 ms  | 36 ms  |
| 11 | as-0-0.bbr1.NewYork1.Level3.net (4.68.128.106)      | 106 ms | 104 ms | 104 ms |
| 12 | ae-0-0.bbr2.SanJose1.Level3.net (64.159.1.130)      | 180 ms | 247 ms | 180 ms |
| 13 | so-14-0.hsa4.SanJose1.Level3.net (4.68.114.158)     | *      | 178 ms | 178 ms |
| 14 | ISC-Level3-fe.SanJose1.Level3.net (209.245.146.219) | 178 ms | 180 ms | 178 ms |
| 15 | f.root-servers.net (192.5.5.241)                    | 180 ms | 178 ms | 180 ms |

# Where is i.root-servers.net ?

traceroute to i.root-servers.net (192.36.148.17), 30 hops max, 40 byte packets

|    |  |      |      |      |
|----|--|------|------|------|
| 1  | net212a.imit.kth.se (130.237.212.2)            | 1 ms | 0 ms | 0 ms |
| 2  | cn4-kf4-p2p.gw.kth.se (130.237.211.205)        | 1 ms | 1 ms | 4 ms |
| 3  | cn5-cn4-p2p.gw.kth.se (130.237.211.201)        | 4 ms | 4 ms | 4 ms |
| 4  | kth1-cn5-p2p.gw.kth.se (130.237.211.41)        | 4 ms | 4 ms | 4 ms |
| 5  | stockholm3-SRP2.sunet.se (130.242.85.65)       | 4 ms | 4 ms | 4 ms |
| 6  | ge-2-2.cyb-gw.sth.netnod.se (194.68.123.73)    | 2 ms | 1 ms | 1 ms |
| 7  | ge-2-1.icyb-gw.sth.netnod.se (192.36.144.190)  | 1 ms | 1 ms | 2 ms |
| 8  | srp-1-1.ibyb-gw.sth.netnod.se (192.36.144.235) | 1 ms | 1 ms | 1 ms |
| 9  | ge-0-0.r1.sth.dnsnode.net (194.146.105.187)    | 1 ms | 2 ms | 2 ms |
| 10 | i.root-servers.net (192.36.148.17)             | 3 ms | 3 ms | 2 ms |



# Dynamic Domain Name System (DDNS)

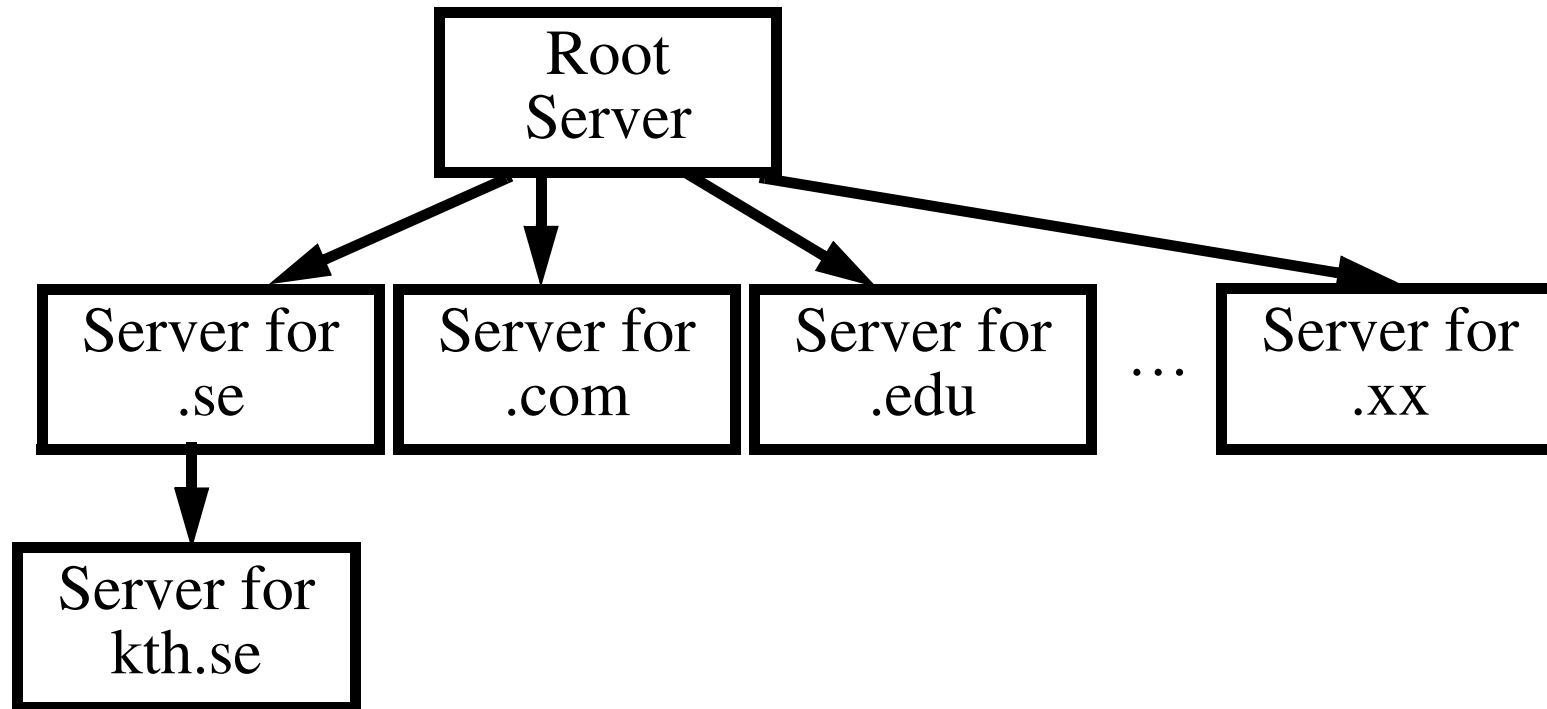

| Host Name | IP-address   |
|-----------|--|
| host_a    | 130.237.x.1  |
| host_b    | 130.237.x.2  |
| host_c    | 130.237.x.3  |
| host_d    | 130.237.x.4  |
| mobile1   | <i>c/o address &lt;&lt;&lt; we can update this dynamically</i> |

# DDNS

## RFC 2136: Dynamic Updates in the Domain Name System (DNS UPDATE)

- add or delete resource records

## RFC 2052: A DNS RR for specifying the location of services (DNS SRV)

- When a SRV-cognizant web-browser wants to retrieve

`http://www.asdf.com/`

it does a lookup of

`http.tcp.www.asdf.com`

## RFC 2535: Domain Name System Security Extensions (DNSSEC)

# Attacks upon DNS

- Denial of service (DoS) and Dystributed DoS (DDoS) attacks agains a DNS server

See for example:

Root server attack on 6 February 2007, Factsheet, ICANN, 1 March 2007

[http://www.icann.org/announcements/factsheet-dns-attack-08mar07\\_v1.1.pdf](http://www.icann.org/announcements/factsheet-dns-attack-08mar07_v1.1.pdf)

- DNS cache poisoning
- DNS spoofing
- ...

# DNS performance

From [www.dnsserverlist.org](http://www.dnsserverlist.org) - 900 servers query times (2010.03.21)

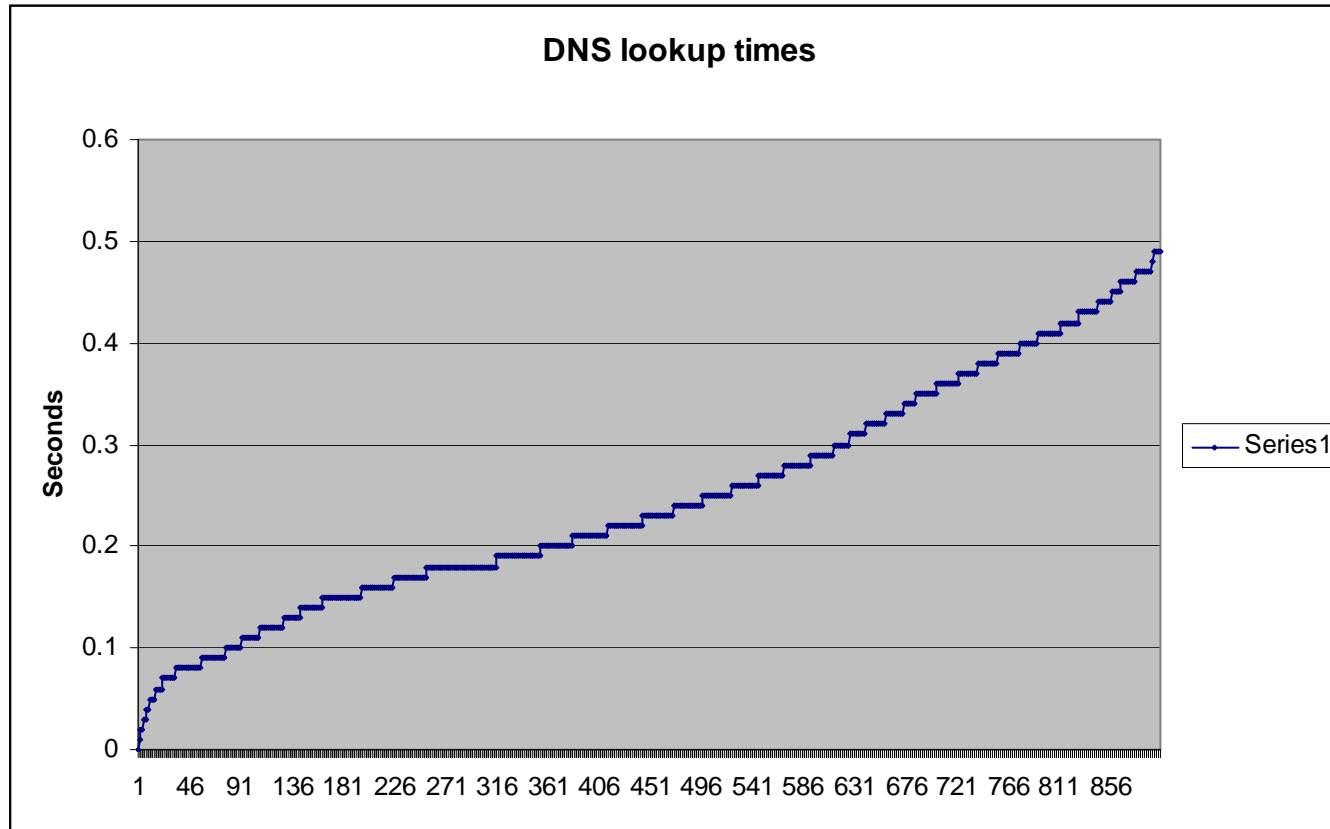

# DNS performance - top 100

From [www.dnsserverlist.org](http://www.dnsserverlist.org) - top 100 servers query times (2010.03.21)

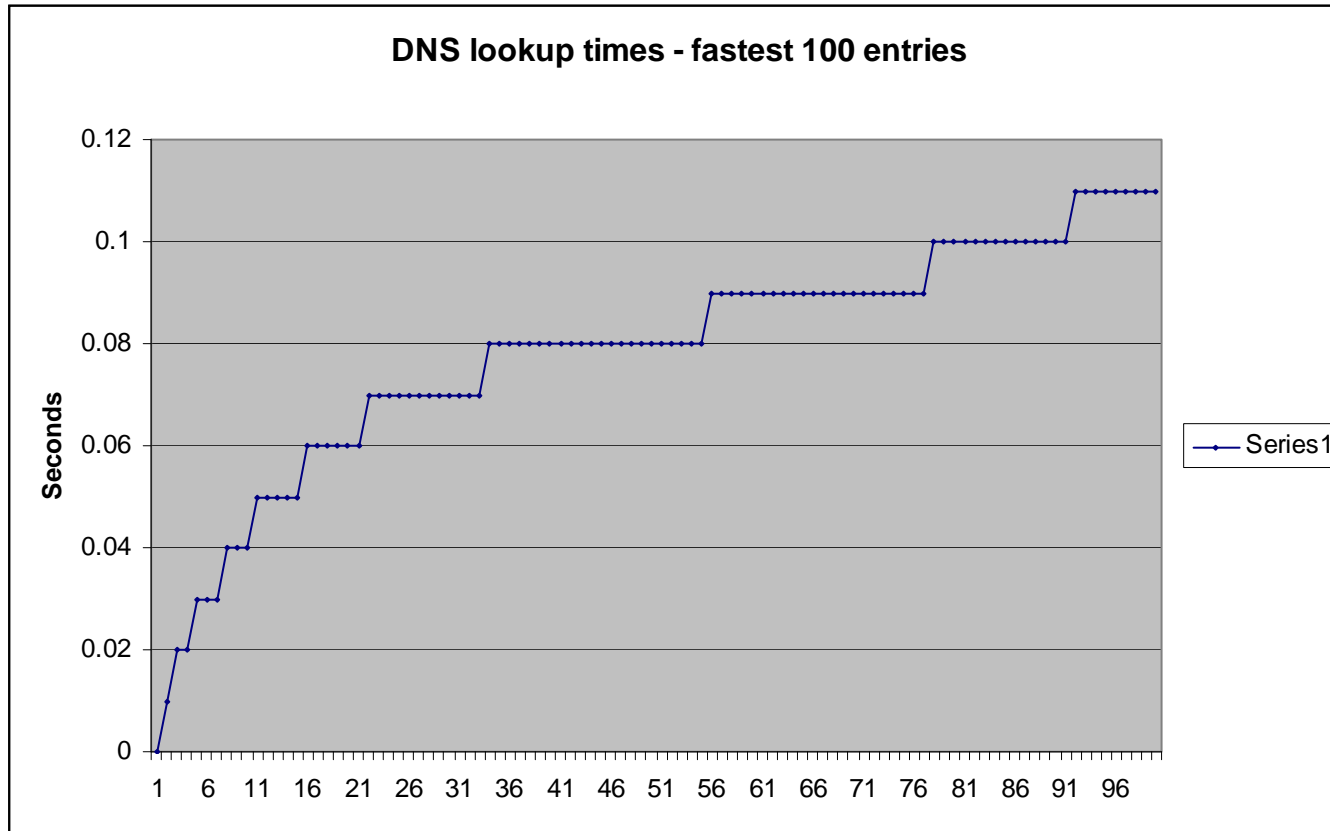

# Web performance

<http://code.google.com/speed/page-speed/docs/using.htm>

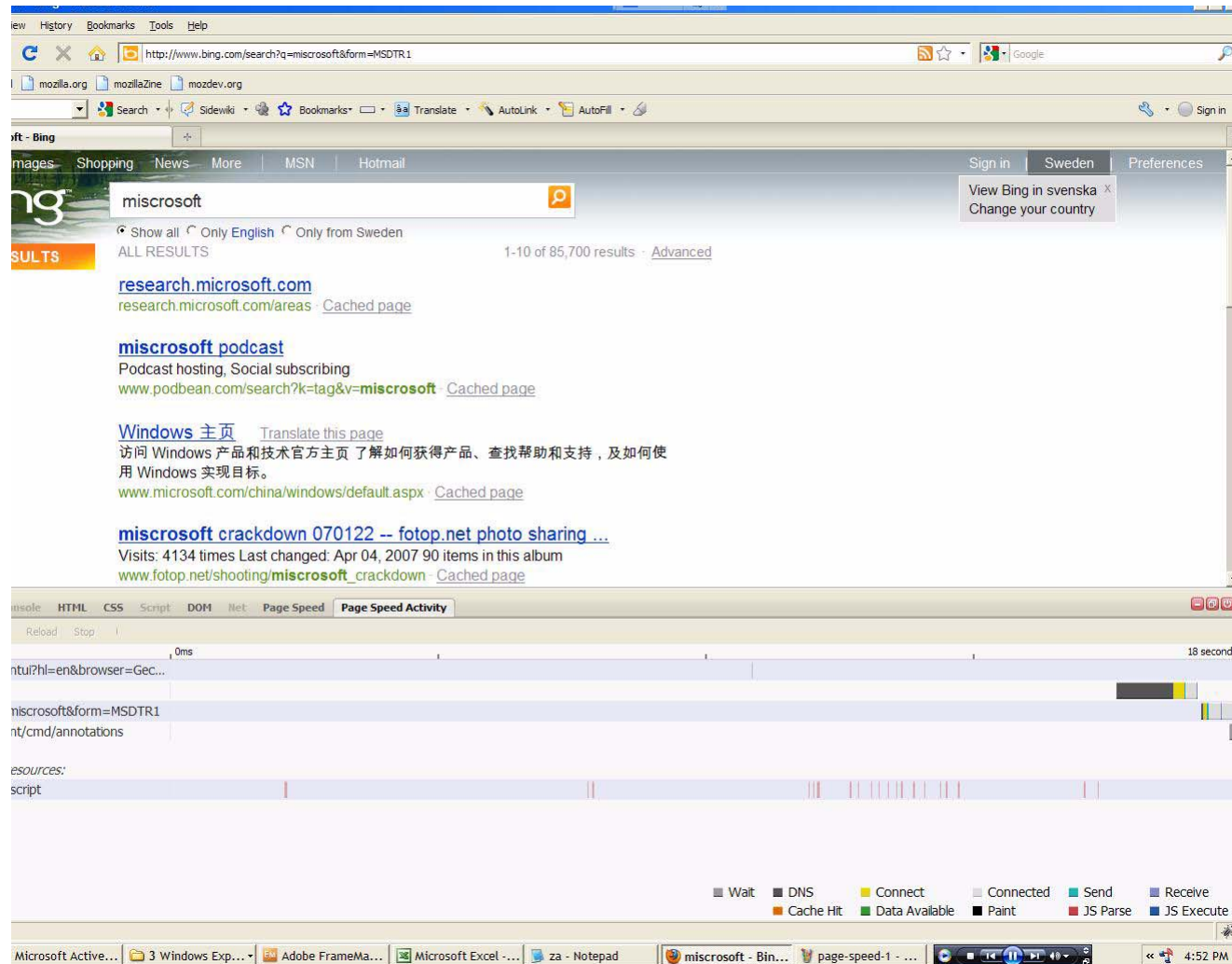

# Web performance - continued

<http://code.google.com/speed/page-speed/docs/using.htm>

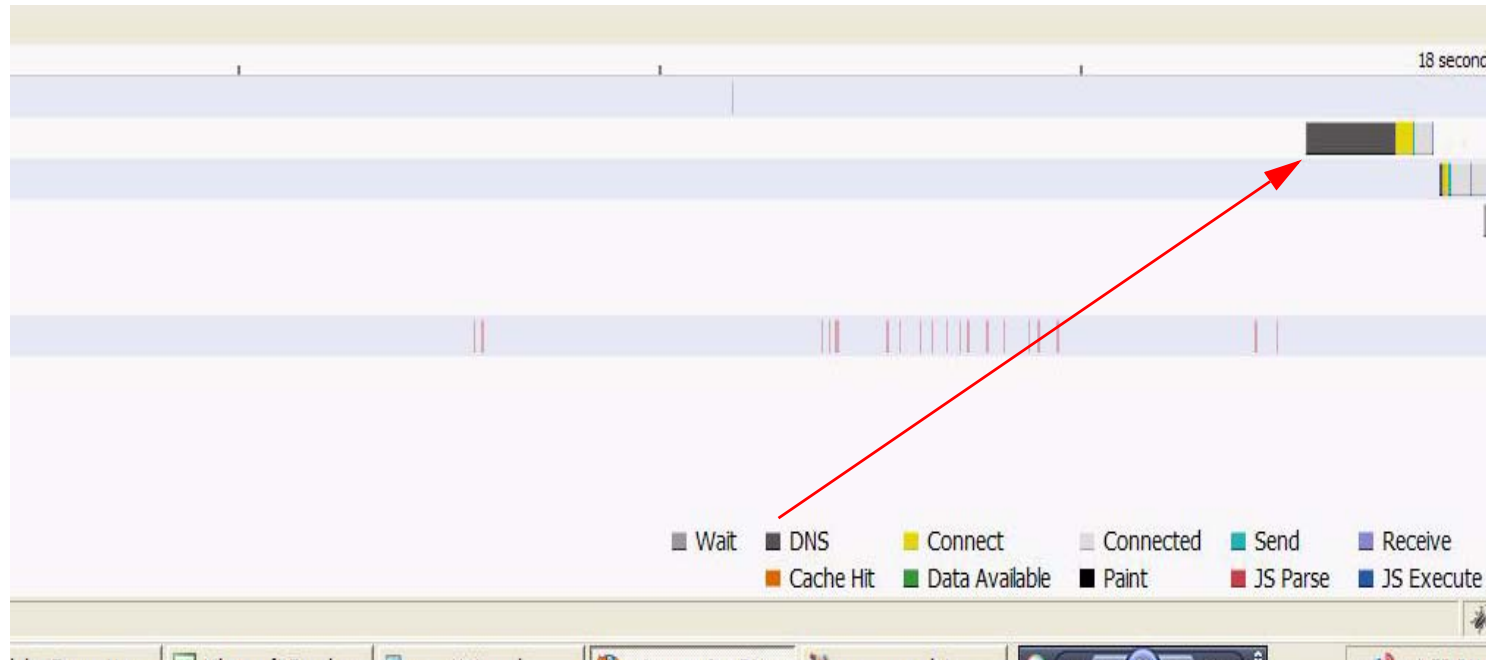

# Public/Commercial DNS services

A number of companies are providing DNS servers to speed up DNS lookups:

- Google Public DNS

<http://code.google.com/speed/public-dns/>

- OpenDNS

<http://www.opendns.com/>

- Scrubit - offering "clean, reliable, and speedy DNS service"

<http://www.scrubit.com/>

- dnsadvantage

<http://www.dnsadvantage.com/>

- ...



# Summary

This lecture we have discussed:

- UDP
- BOOTP
- DHCP
- DNS, DDNS

# References

- [1] Joe Abley, f.root-servers.net, NZNOG 2005, February 2005, Hamilton, NZ  
<http://www.isc.org/pubs/pres/NZNOG/2005/F%20Root%20Server.pdf>

# IK1550 Internetworking/Internetteknik

## Spring 2010, Period 4

### Module 5: TCP, HTTP, RPC, NFS, X

Lecture notes of G. Q. Maguire Jr.



KTH Information and  
Communication Technology

© 2010 G.Q.Maguire Jr. .

All rights reserved. No part of this course may be reproduced, stored in a retrieval system, or transmitted, in any form or by any means, electronic, mechanical, photocopying, recording, or otherwise, without written permission of the author.

Last modified: 2010.03.21:17:34

# Lecture 4: Outline

- TCP
- HTTP
- Web enabled devices
- RPC, XDR, and NFS
- X Window System, and
- some tools for looking at these protocols

# Transport layer protocols

- User Datagram Protocol (UDP)
  - Connectionless **unreliable** service
- Transmission Control Protocol (TCP) <<< **today's topic**
  - Connection-oriented **reliable stream** service
- Stream Control Transmission Protocol (SCTP)
  - a modern transmission protocol with many facilities which the user can chose from

# Transmission Control Protocol (TCP)

TCP provides a **connection oriented**, **reliable**, **byte stream** service[1].

- TCP utilizes full-duplex **connections**
  - Note: There are just **two endpoints**
- TCP applications write 8-bit bytes to a **stream** and read bytes from a stream
  - TCP decides how much data to send (not the application) - each unit is a **segment**
  - There are no records (or record makers) - just a stream of bytes  $\Rightarrow$  the receiver can't tell how much the sender wrote into the stream at any given time
- TCP provides **reliability**
  - Acknowledgements, timeouts, retransmission, ...
- TCP provides **flow control**
- TCP trys to **avoid** causing **congestion**

## Applications which use TCP

Lots of applications have been implemented on top of the TCP, such as:

- TELNET °— provides a virtual terminal {emulation}
- FTP — used for file transfers
- SMTP — forwarding e-mail
- HTTP — transport data in the World Wide Web

Here we will focus on some features not covered in the courses: Telesys, gk and Data and computer communication.

# TCP Header

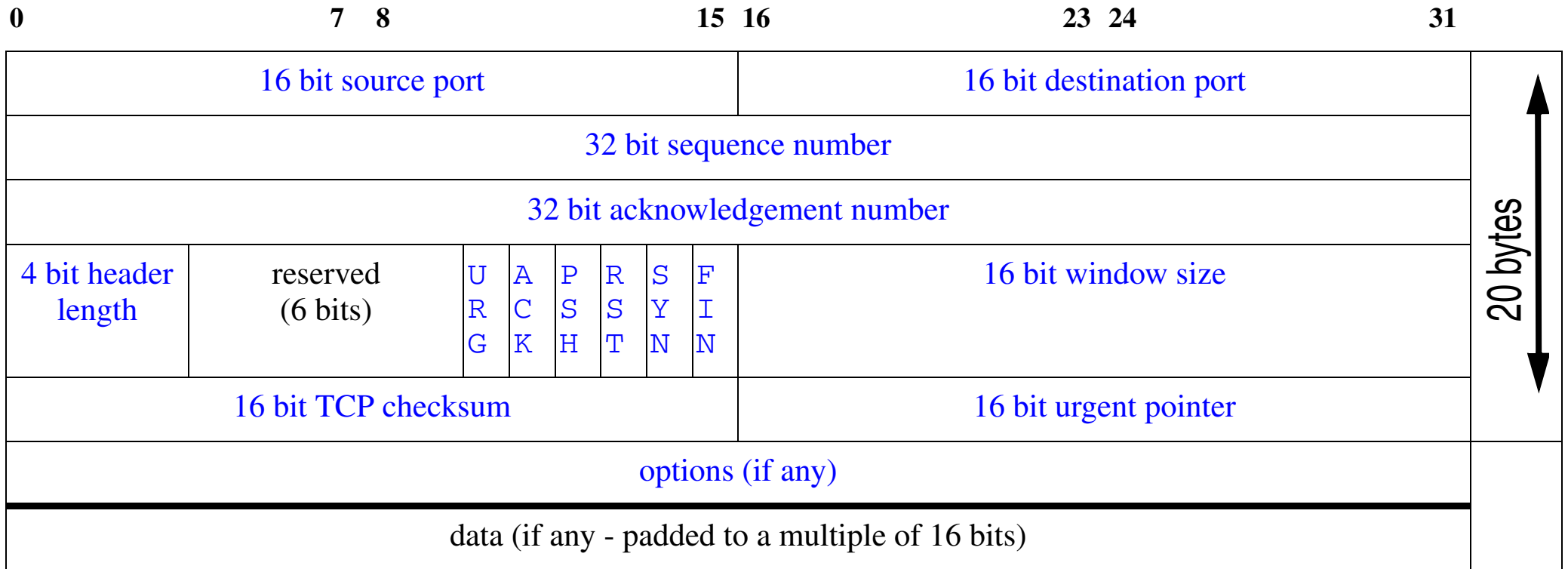

Figure 1: IP header (see Stevens, Vol. 1. inside cover or Forouzan figure 12.5 pg. 282)

Just as with UDP, TCP provides **de/multiplexing** via the 16 bit source and destination ports.

The 4 bit **header length** indicates the number of **4-byte words** in the TCP header



# TCP header continued

**Reliability** is provided by the 32 bit **sequence number** which indicates the byte offset in a stream of the first byte in this segment and a 32 bit **acknowledgement number** which indicates the next byte which is **expected**.

- The initial sequence number (ISN) is a random 32 bit number.
- Note that the **acknowledgement** is **piggybacked** in each TCP segment
  - TCP maintains a timer for *each* segment. If an acknowledgement is not received before the timeout, then TCP retransmits the segment
  - When TCP receives data it sends an acknowledgement back to sender
- TCP applies an end-to-end **checksum** on its header and data
  - The **checksum** is mandatory - but otherwise similar to the UDP checksum
- TCP **resequences** data at the receiving side  $\Rightarrow$  all the bytes are delivered in order to the receiving application
- TCP **discards duplicate** data at the receiving side

**Urgent pointer** - specifies that the stream data is offset and that the data field begins with "urgent data" which is to bypass the normal stream - for example ^C

**Control field** - indicates the purpose & contents of this segment:

| Flag | Description  |
|------|--|
| URG  | The urgent pointer is valid  |
| ACK  | The acknowledgement number is valid  |
| PSH  | Push the data, i.e., the receiver should immediately pass all the data to the application ⇒ emptying the receiver's buffer |
| RST  | Connection must be reset   |
| SYN  | Synchronize the sequence numbers   |
| FIN  | Terminate the connection (from the <b>sender's</b> point of view)  |

We will see how these bits are used as we examine each of them later.

The **window size** (or more exactly the receive window size (rwnd)) - indicates how many bytes the receiver is prepared to receive (this number is **relative** to the acknowledgement number).

**Options** - as with UDP there can be up to 40 bytes of options (we will cover these later)

# Connection establishment

## 3-way handshake:

- Guarantees **both** sides are ready to transfer data
- Allows both sides to agree on initial sequence numbers

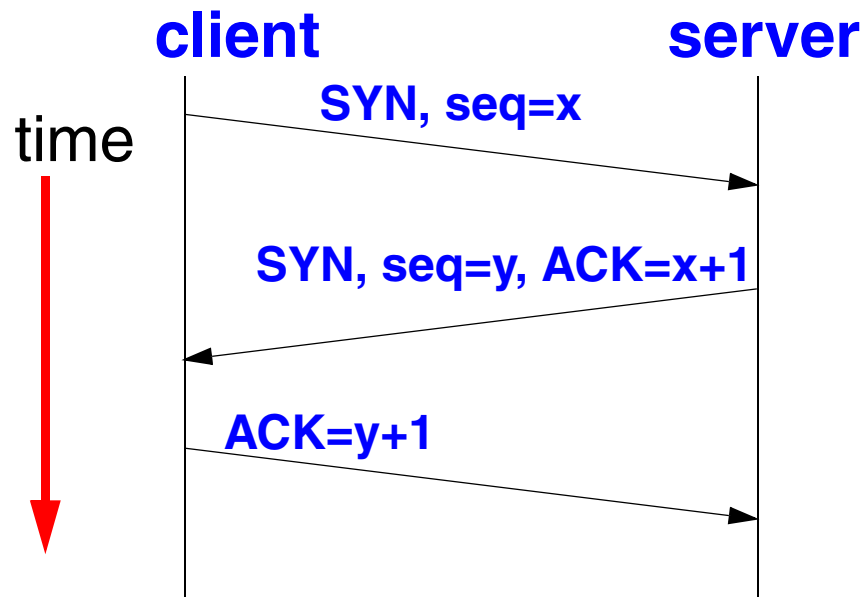

See Forouzan figure 12.9 page 286

Initial sequence number (ISN) **must** be chosen so that each instance of a specific TCP connection between two end-points has a different ISN.

The entity initiating the connection is (normally) called the "client".

# SYN Flooding Attack

It is clear that if a malicious user simply sends a lot of SYN segments to a target machine (with faked source IP addresses)  $\Rightarrow$  this machine will spend a lot of resources to set up TCP connections which subsequently never occur.

As the number of TCP control blocks and other resources are finite

- legitimate connection requests can't be answered
- the target machine might even crash

The result is to deny service, this is one of many **Denial of Services (DoS) Attacks**

# Connection teardown

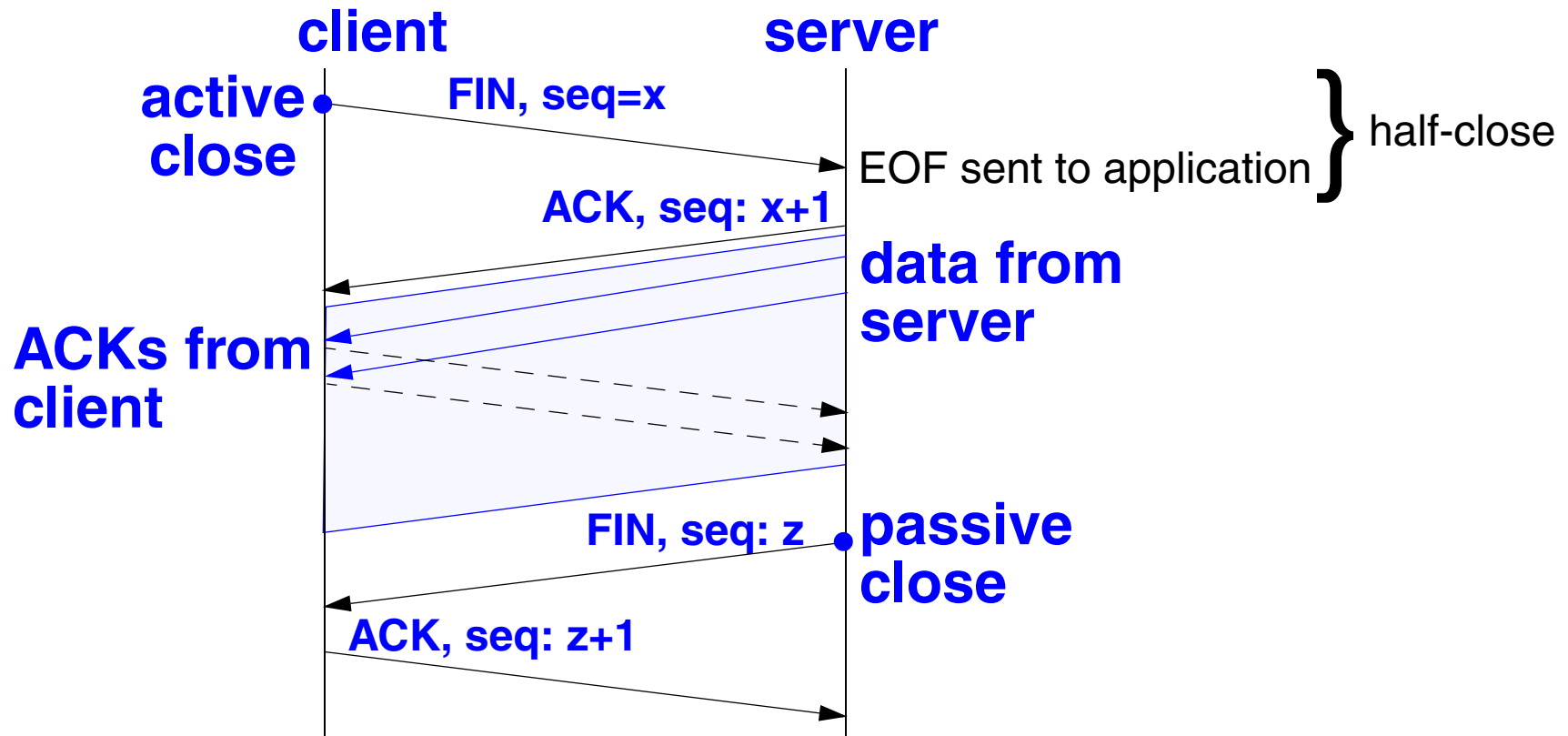

See Forouzan figure 12.12 page 291

- **Note:** it takes 4 segments to complete the close.
- Normally, the client performs an **active close** and the server performs **passive close**.

# TCP options

These options are used to convey additional information to the destination or to align another options

- **Single-byte Options**
  - No operation
  - End of option
- **Multiple-byte Options**
  - Maximum segment size
  - Window scale factor
  - Timestamp

A TCP header can have up to 40 bytes of optional information.

## Maximum Segment Size

- The Maximum Segment Size (MSS) is the largest amount of data TCP will send to the other side
- MSS can be announced in the **options** field of the TCP header during connection establishment
- If a MSS is not announced  $\Rightarrow$  a default value of 536 is assumed
- In general, the larger MSS is the better -- until fragmentation occurs
  - As when fragmentation occurs the overhead increases!

# Sliding window Flow control

- receiver: **offered window** - acknowledges data sent and what it is prepared to receive
  - thus the sender can send an ACK, but with a offered window of 0
  - later the sender sends a **window update** with a non-zero offered window size
  - the receiver can increase or decrease this window size as it wants
- sender: **usable window** - how much data it is prepared to send immediately

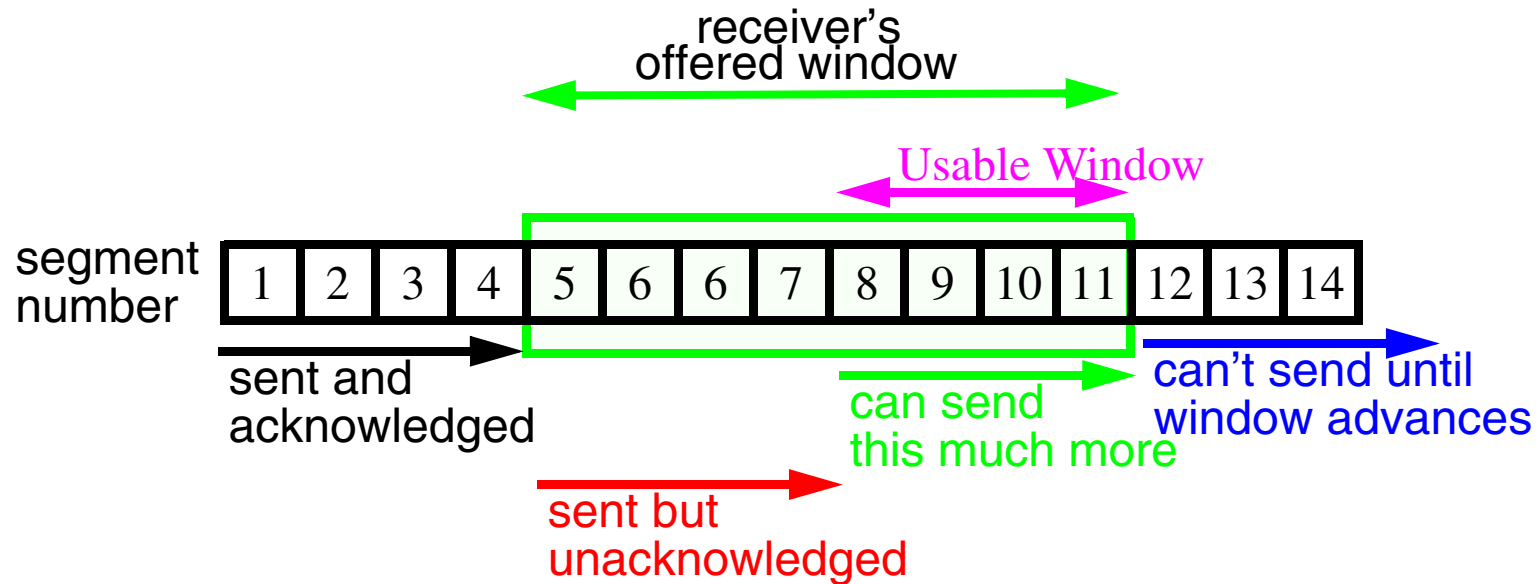



## Window size

Increasing window size can improve performance - more recent systems have increased buffer size ranging from 4096 ... 16,384 bytes. The later produces ~40% increase in file transfer performance on an ethernet.

Socket API allows user to change the size of the send and receive buffers.

# Flow for an rlogin session

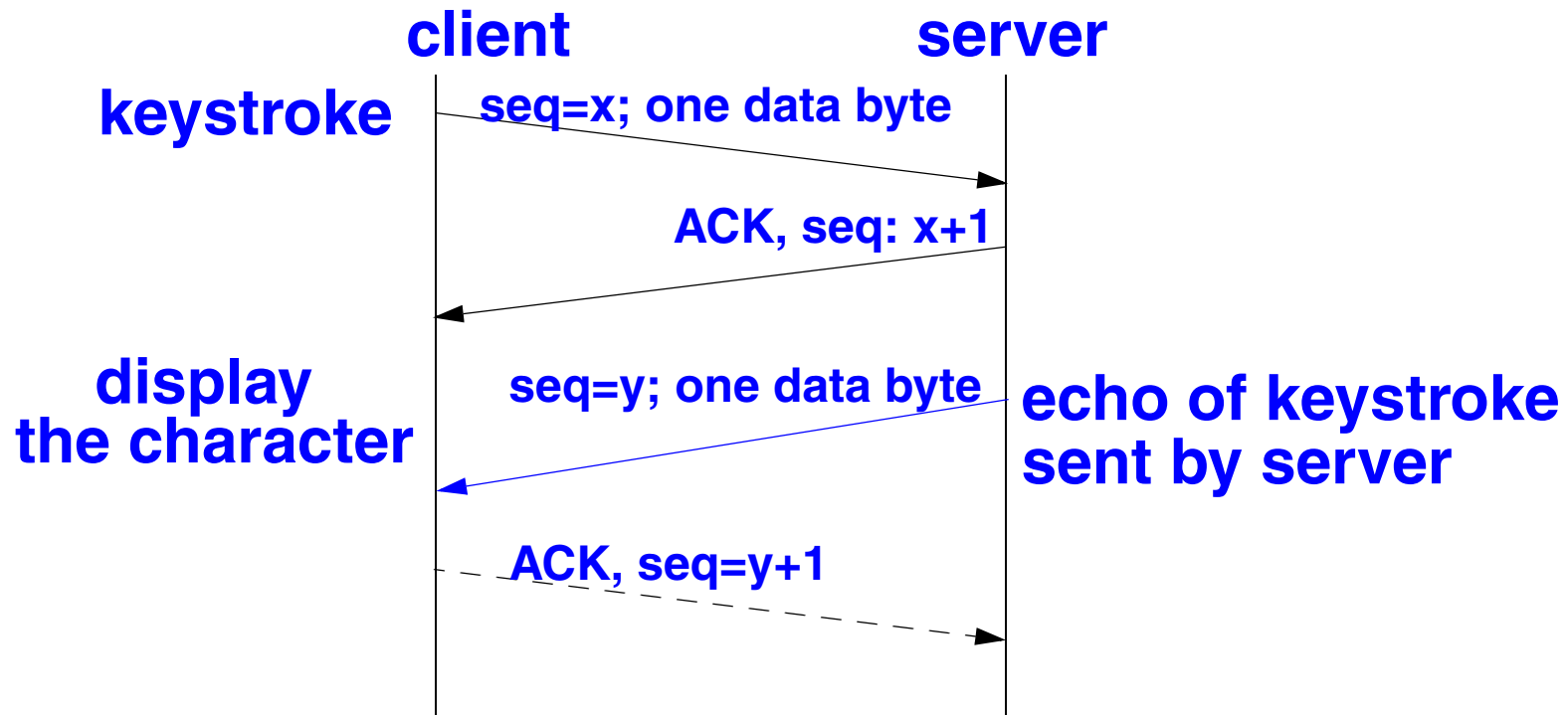

See Forouzan figure 12.12 page 291

Thus **each** keystroke not only generates a byte of data for the remote application which has to be sent in a segments, but this will trigger an ACK along with an echo & its ACK  $\Rightarrow$  generates 3 more segments! All to send a single byte of user data!!!

# Silly Window Syndrome

If receiver advertises a small window, then sender will send a small amount of data, which fills receivers window, ... .

To prevent this behavior:

- sender does not transmit unless:
  - full-size segment can be sent OR
  - it can send at least 1/2 maximum sized window that the other has ever advertised
  - we can send everything we have and are not expecting an ACK or **Nagle algorithm** is disabled
- receiver must not advertise small segments
  - advertise **min**(a full-size segment, 1/2 the receive buffers space)
  - **delayed ACKs**

# Nagle Algorithm

telnet/rlogin/... generate a packet (41 bytes) for each 1 byte of user data

- these small packets are called “tinygrams”
- not a problem on LANs
- adds to the congestion on WANs

## Nagle Algorithm

- each TCP connection can have only one outstanding (i.e., unacknowledged) small segment (i.e., a tinygram)
- while waiting - additional data is accumulated and sent as one segment when the ACK arrives
- self-clock: the faster ACKs come, the more often data is sent
  - thus automatically on slow WANs fewer segments are sent

Round trip time on a typical ethernet is ~16ms (for a single byte to be sent, acknowledged, and echoed) - thus to generate data faster than this would require typing faster than 60 characters per second! Thus rarely will Nagle be invoked on a LAN.

## Disabling the Nagle Algorithm

But sometimes we need to send a small message - without waiting (for example, handling a mouse event in the X Window System) - therefore we set:

- `TCP_NODELAY` on the socket
- Host Requirements RFC says that hosts **must** implement the Nagle algorithm, but there **must** be a way to disable it on individual connections.

## Delayed acknowledgements

Rather than sending an ACK immediately, TCP waits ~200ms hoping that there will be data in the reverse direction - thus enabling a piggybacked ACK.

- Host Requirements RFC states the delays must be less than 500ms
- Implementations often use a periodic 200ms timer - rather than setting a timer specifically for computing this delay
  - similar to the periodic 500ms timer used for detecting timeouts

A complex protocol with several timers leads to complex behavior!

## Resulting bulk data flow

Every segment carries a full MSS worth of data.

Typically an ACK every other segment.

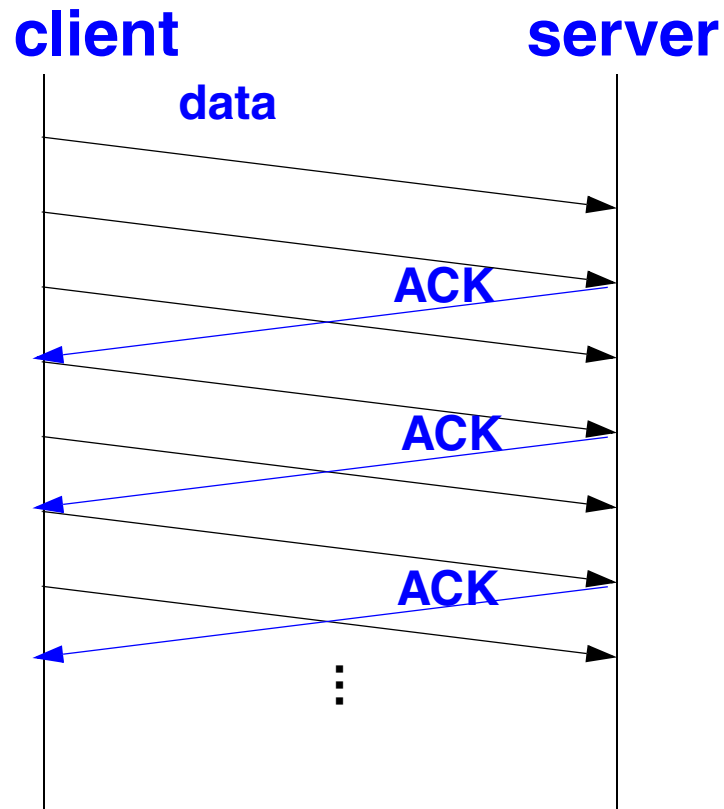

## Bandwidth-Delay Product

How large should the window be for optimal throughput?

Calculate the capacity of the pipe as:

- $\text{capacity}(\text{bits}) = \text{bandwidth}(\text{bits}/\text{sec}) * \text{RTT}(\text{sec})$
- This is the size the receiver advertised window should have for optimal throughput.

Example:

T1 connection across the US:

$$\text{capacity} = 1.544\text{Mbit}/\text{s} * 60\text{ms} = 11,580 \text{ bytes}$$

Gigabit connection across the US:

$$\text{capacity} = 1\text{Gbit}/\text{s} * 60\text{ms} = 7,500,000 \text{ bytes!}$$

However, the window size field is only 16 bits  $\Rightarrow$  maximum value of 65535 bytes

For **Long Fat Pipes** we can use the window scale option to allow much larger window sizes.



# Congestion Avoidance

So far we have assumed that the sender is only limited by the receiver's available buffer space. But if we inject lots of segments into a network - upto window size advertised by receiver

- works well if the hosts are on the same LAN
- if there are routers (i.e., queues) between them and if the traffic arrives faster than it can be forwarded, then either the packets have to be
  - buffered or
  - thrown away - we refer to this condition as **congestion**

Lost packets lead to retransmission by the sender

This adds even more packets to the network  $\Rightarrow$  **network collapse**

Therefore we need to be able to reduce the window size to **avoid** congestion.

# Congestion Control

We introduce a Congestion Window

- Thus the sender's window size will be determined both by the receiver and in reaction to congestion in the network

Sender maintains 2 window sizes:

- Receiver-advertised window (rwnd)
  - **advertised window** is flow control imposed by **receiver**
- Congestion window (CWND)
  - **congestion window** is flow control imposed by **sender**

Actual window size =  $\min(\text{rwnd}, \text{CWND})$

To deal with congestion, sender uses several strategies:

- Slow start
- Additive increase of CWND
- Multiplicative decrease of CWND

## Slow start

In 1989, Van Jacobson introduced **slow start** based on his analysis of actual traffic and the application of control theory. All TCP implementations are now required to support slow start.

- the rate at which new packets should be injected into the network is the rate at which acknowledgements are returned

- cwnd starts at number of bytes in one segment (as announced by other end) and increases exponentially with successfully received cwnd worth of data

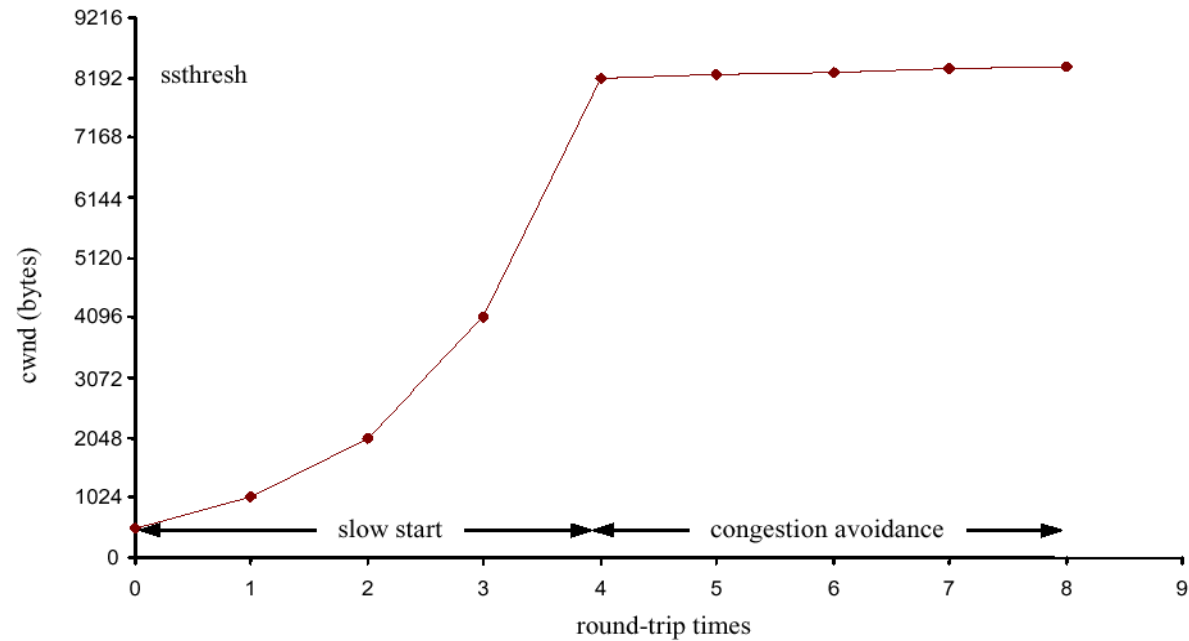

Figure 2: Graphical plot of congestion window (cwnd) as the connection goes from slow start to congestion avoidance behavior (figure from Mattias Ronquist, “TCP Reaction to Rapid Changes of the Link Characteristics due to Handover in a Mobile Environment”, MS Thesis, Royal Institute of Technology, Teleinformatics, August 4, 1999.)

## Round-Trip Time Measurement

Fundamental to TCP's timeout and retransmission is the measurement (M) of the round-trip time (RTT). As the RTT changes TCP should modify its timeouts.

Originally TCP specified:

$$R \leftarrow \alpha R + (1 - \alpha)M$$

$\alpha$  a smoothing factor, with a recommended value of 0.9

$$RTO = R\beta$$

$\beta$  a delay variance factor, with a recommended value of 2

RTO == retransmission timeout time

Van Jacobson found that this could not keep up with wide fluctuations in RTT, which leads to more retransmissions, when the network is already loaded! So he proposed tracking the variance in RTT and gave formulas which compute the RTO based on the **mean** and **variance** in RTT and can be easily calculated using integer arithmetic (see Stevens, Vol. 1, pg. 300 for details).

## Karn's algorithm

When a retransmission occurs, RTO is backed off, the packet retransmitted with the new longer RTO, and an ACK is received.

But is it the original ACK or the new ACK?

- we don't know, thus we don't recalculate a new RTO until an ACK is received for a segment which is not retransmitted

# Congestion Avoidance Algorithm

Slow start keeps increasing cwnd, but at some point we hit a limit due to intervening routers and packets start to be dropped.

The algorithm assumes that packet loss means congestion<sup>1</sup>. Signs of packet loss:

- timeout occurring
- receipt of duplicate ACKs

Introduce another variable for each connection: ssthresh == slow start threshold

when data is acknowledged we increase cwnd:

- if  $cwnd < ssthresh$  we are doing slow start; increases continue until we are half way to where we hit congestion before
- else we are doing congestion avoidance; then increase by  $1/cwnd + 1/8$  of segment size each time an ACK is received

(See Stevens, Vol. 1, figure 21.8, pg. 311 for a plot of this behavior)

---

1. Note: if your losses come from other causes (such as bit errors on the link) it will still think it is due to congestion!

## Van Jacobson's Fast retransmit and Fast Recovery Algorithm

TCP is required to generate an immediate ACK (a duplicate ACK) when an out-of-order segment is received. This duplicate ACK should not be delayed. The purpose is to tell the sender that the segment arrived out of order and what segment number the receiver expects.

Cause:

- segments arriving out of order OR
- lost segment

If more than a small number (3) of duplicate ACKs are detected, assume that a segment has been lost; then retransmit the missing segment immediately (without waiting for a retransmission timeout) and perform congestion avoidance - but not slow start.

Why not slow start? Because the only way you could have gotten duplicate ACKs is if subsequent segments did arrive - which means that data is getting through.



## Per-Route Metrics

Newer TCPs keeps smoothed RTT, smoothed mean deviation, and slow start threshold in the routing table.

When a connection is closed, if there was enough data exchanged (defined as 16 windows full) - then record the parameters

- i.e., 16 RTT samples  $\Rightarrow$  smoothed RTT is accurate to  $\sim 5\%$

## TCP Persist Timer

If the window size is 0 and an ACK is lost, then receiver is waiting for data and sender is waiting for a non-zero window!

To prevent deadlock, introduce a **persist timer** that causes sender to query the receiver periodically with **window probes** to find out if window size has increased.

Window probes sent every 60 seconds - TCP never gives up sending them.

# TCP Keepalive Timer

No data flows across an idle TCP connection - connections can persist for days, months, etc. Even if intermediate routers and links go down the connection persists!

However, some implementations have a **keepalive timer**.

Host Requirements RFC gives 3 reasons **not** to use keepalive messages:

- can cause perfectly good connections to be dropped during transient failures
- they consume unnecessary bandwidth
- they produce additional packet charges (if you are on a net that charges per packet)

Host Requirements RFC says you can have a keepalive time but:

- it must not be enabled unless an application specifically asks
- the interval must be configurable, with a default of no less than 2 hrs.

# TCP Performance

TCP's path MTU discovery:

- use **min**(MTU of outgoing interface, MSS announced by other end)
- use per-route saved MTU
- once an initial segment size is chosen - all packets have don't fragment bit set
- if you get an ICMP "Can't fragment" message - recompute Path MTU.
- periodically check for possibility of using a larger MTU (RFC 1191 recommends 10 minute intervals)

# Long Fat Pipes

Networks with large bandwidth-delay products are called **Long Fat Networks (LFNs)** - pronounced “elephants”.

TCP running over a LFN is a **Long Fat Pipe**.

- Window Scale option - to avoid 16 bit window size limit
- Timestamp option - putting a time stamp in each segment allows better computation of RTT
- **Protection Against Wrapped Sequence Numbers (PAWS)** - with large windows you could have sequence number wrap around and not know which instance of a given sequence number is the correct one; solved by using timestamps (which must simply be monotonic)
- T/TCP - TCP extension for Transactions; to avoid the three way handshake on connection setup and shorten the TIME\_WAIT state. (for details of T/TCP see Stevens, Vol.3)

# Measuring TCP Performance

Measured performance:

- Performance on Ethernets at ~90% of theoretical value (using workstations)
- TCP over FDDI at 80-98% of theoretical value
- TCP (between two Crays) at 781 Mbits/sec over a 800Mbit/sec HIPPI channel
- TCP at 907Mbits/sec on a loopback interface of a Cray Y-MP.

Practical limits:

- can't run faster than the slowest link
- can't go faster than the memory bandwidth of the slowest machine (since you have to touch the data at least once)
- you can't go faster than the window size offered by the receiver divided by the round trip time (comes from the calculation of the bandwidth delay product)
  - thus with the maximum window scale factor (14)  $\Rightarrow$  window size of 1.073 Gbits; just divide by RTT to find the maximum bandwidth

# Example of TCP behavior <sup>1</sup>

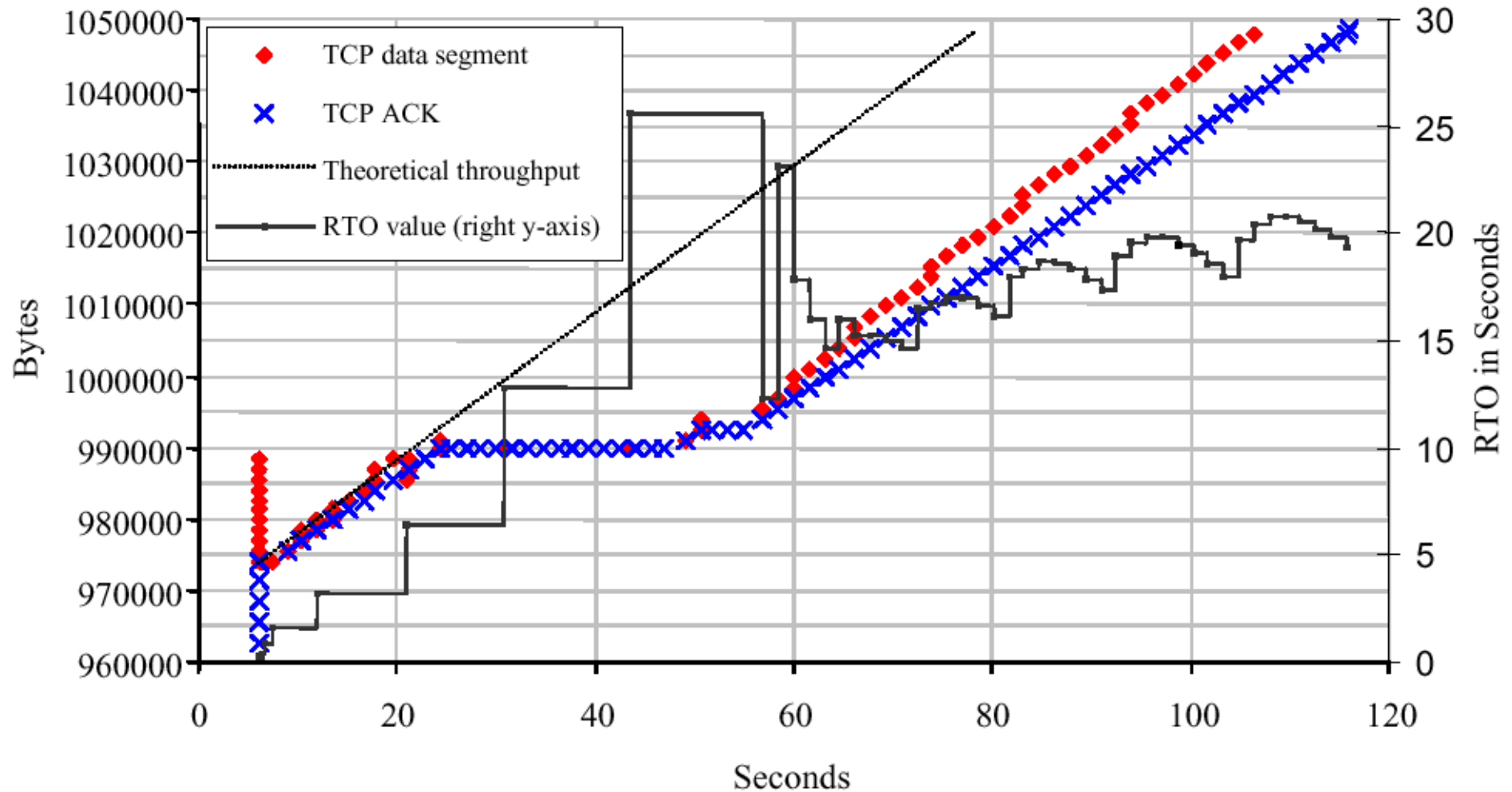

**Figure 7-3:** TCP segments and ACKs collected at the correspondent host after the handover. The RTO values and the theoretical throughput of the PPP link are also included.

1. Figure 7-3, from Mattias Ronquist, "TCP Reaction to Rapid Changes of the Link Characteristics due to Handover in a Mobile Environment", MS Thesis, Royal Institute of Technology, Teleinformatics, August 4, 1999, p.38.

# TCP servers

Stevens, Vol. 1, pp. 254-260 discusses how to design a TCP server, which is similar to list of features discussed for UDP server, but now it is incoming connection requests which are queued rather than UDP datagrams

- note that incoming requests for connections which exceed the queue - are silently ignored - it is up to the sender to time out it active open
- this limited queuing has been one of the targets of denial of service attacks
  - TCP SYN Attack - see <http://cio.cisco.com/warp/public/707/4.html>
  - Increase size of the SYN\_RCVD queue (kernel variable somaxconn limits the maximum backlog on a listen socket - backlog is the sum of both the SYN\_RCVD and accept queues) and decrease the time you will wait for an ACK in response to your SYN\_ACK
  - for a nice HTTP server example, see <http://www.cs.rice.edu/CS/Systems/Web-measurement/paper/node3.html>



# Hypertext Transfer Protocol (HTTP)

This protocol is the basis for the World Wide Web (WWW).

Uses TCP connections. HTTP traffic growing at a very high rate - partly due to popularity and partly due to the fact that it can easily include text, pictures, movies, . . . .

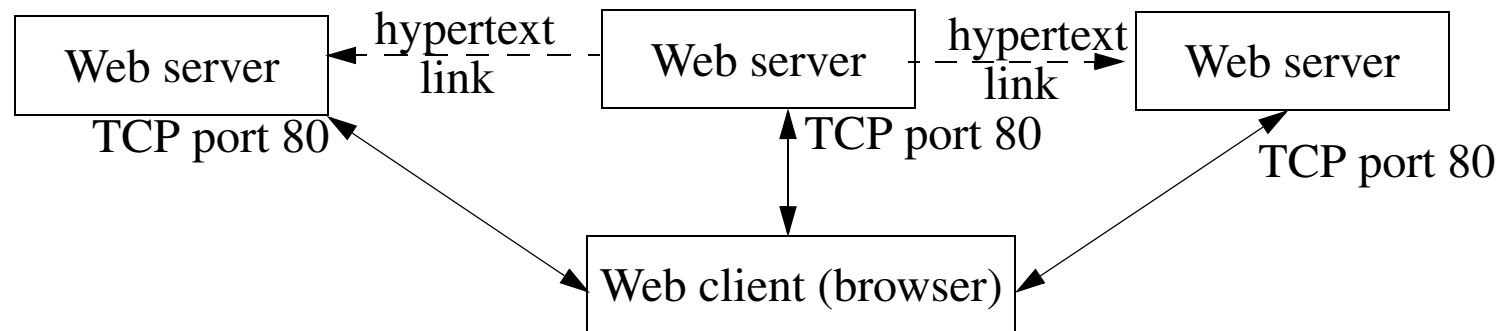

Figure 3: Organization of a Web client-server  
(see Stevens, Vol. 3, figure 15.1, pg. 210)

HTTP described by an Internet Draft in 1993; replaced with RFC 1945, “*Hypertext Transfer Protocol -- HTTP/1.0*”, May 1996; RFC 2068, “*Hypertext Transfer Protocol -- HTTP/1.1*”, January 1997; replaced by RFC 2616, June 1999, RFC 2817 “*Upgrading to TLS Within HTTP/1.1*”, May 2000.

# HTTP Protocol

2 message types:

- request

## HTTP 1.0 request

request line

headers (0 or more)

<blank\_line>

body (only for a POST request)

- response

## HTTP/1.0 response

status line

headers (0 or more)

<blank\_line>

body

# HTTP Requests

request-line == request request-URI HTTP-version

Three requests:

- GET - returns information identified by request URI
- HEAD - similar to GET but only returns header information
- POST - sends a body with a request; used for posting e-mail, news, sending a fillin form, etc.

Universal Resource Identifiers (URIs) - described in RFC 1630, URLs in RFC 1738 and RFC 1808.

status-line == HTTP-version response-code response-phrase

# HTTP Header fields

HTTP Header names (See Stevens, figure 13.3, Vol. 3, pg. 166)

| Header name       | Request? | Response? | Body? |
|-------------------|----------|-----------|-------|
| Allow             |          |           | 2     |
| Authorization     | 2        |           |       |
| Content-Encoding  |          |           | 2     |
| Content-Length    |          |           | 2     |
| Content-Type      |          |           | 2     |
| Date              | 2        | 2         |       |
| Expires           |          |           | 2     |
| From              | 2        |           |       |
| If-Modified-Since | 2        |           |       |
| Last-Modified     |          |           | 2     |
| Location          |          | 2         |       |
| MIME-Version      | 2        | 2         |       |
| Pragma            | 2        | 2         |       |
| Referer           | 2        |           |       |
| Server            |          | 2         |       |
| User-Agent        | 2        |           |       |
| WWW-Authenticate  |          | 2         |       |

# HTTP Response Codes

HTTP 3-digit response code (See Stevens, figure 13.4, Vol. 3, pg. 167)

| Response | Description   |
|----------|---|
| 1yz      | Informational. Not currently used                             |
|          | Success   |
| 200      | OK, request succeeded.  |
| 201      | OK, new resource created (POST command)                       |
| 202      | Request accepted but processing not completed                 |
| 204      | OK, but no content to return                                  |
|          | Redirection; further action needs to be taken by user agent   |
| 301      | Requested resource has been assigned a new permanent URL      |
| 302      | Requested resource resides temporarily under a different URL  |
| 304      | Document has not been modified (conditional GET)              |
|          | Client error  |
| 400      | Bad request   |
| 401      | Unauthorized; request requires user authentication            |
| 403      | Forbidden for unspecified reason                              |
| 404      | Not found   |
|          | Server error  |
| 500      | Internal server error   |
| 501      | Not implemented   |
| 502      | Bad gateway; invalid response from gateway or upstream server |
| 503      | Service temporarily unavailable                               |

# Client Caching

Client can cache HTTP documents along with the date and time the document was fetched.

If the document is cached, then the If-Modified-Since header can be sent to check if the document has changed since the copy was cached - thus saving a transfer - but costing a round trip time and some processing time. This is called a conditional GET.

# Server Redirect

Response code 302, along with a new location of the request-URI.

## Multiple simultaneous connections to server

GET of a page with multiple objects on it (such as GIF images) - one new connection for each object, all but the first can occur in parallel!

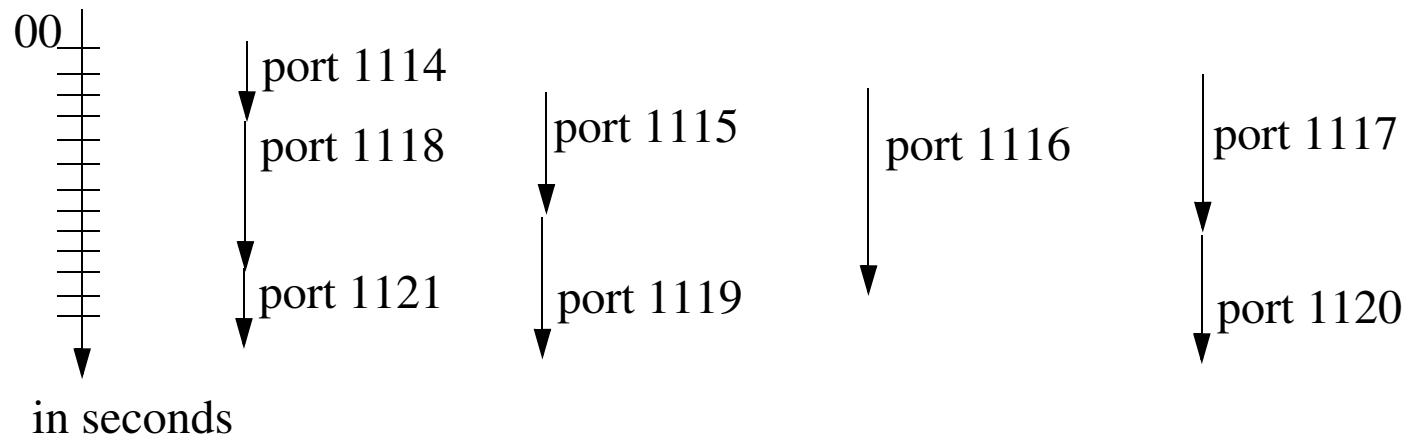

Figure 4: Timeline of eight TCP connection for a home page and seven GIF images  
(see Stevens, Vol. 3, figure 113.5, pg. 171)

Note that the port 1115, 1116, and 1117 requests start before 1114 terminates, Netscape can initiate 3 non-blocking connects after reading the end-of-file but before closing the first connection.



## Decrease in total time to produce a response:

(from Stevens, figure 13.6, Vol. 3, pg. 171)

| Simultaneous connections | Total time (seconds) |
|--------------------------|----------------------|
| 1                        | 14.5                 |
| 2                        | 11.4                 |
| 3                        | 10.5                 |
| 4                        | 10.2                 |
| 5                        | 10.2                 |
| 6                        | 10.2                 |
| 7                        | 10.2                 |

Why no improvement beyond 4?

- program has an implementation limit of 4, even if you specify more!
- gains beyond 4 are probably small (given the small difference between 3 and 4) - but Steven's has not checked!

# Problems with multiple connections

Such multiple connection have problems:

- Unfair to other protocols (such as FTP) which are using one connection at a time to fetch multiple files
- Congestion information is not passed to the other connections
- can more easily overflow the server's incomplete connection queue which can lead to large delays as the host retransmits SYNs.
  - ◆ In fact it looks like a denial of service attack -- which is trying to flood the host!

# HTTP Statistics

Statistics for individual HTTP connections (see Stevens, figure 13.7, Vol. 3, pg. 172)

|                               | Median | Mean  |
|-------------------------------|--------|-------|
| client bytes/connection       | 224    | 266   |
| server bytes/connection       | 3,093  | 7,900 |
| connection duration (seconds) | 3.4    | 22.3  |

Mean is often skewed by very large transfers.

# What happens when you make an HTTP request

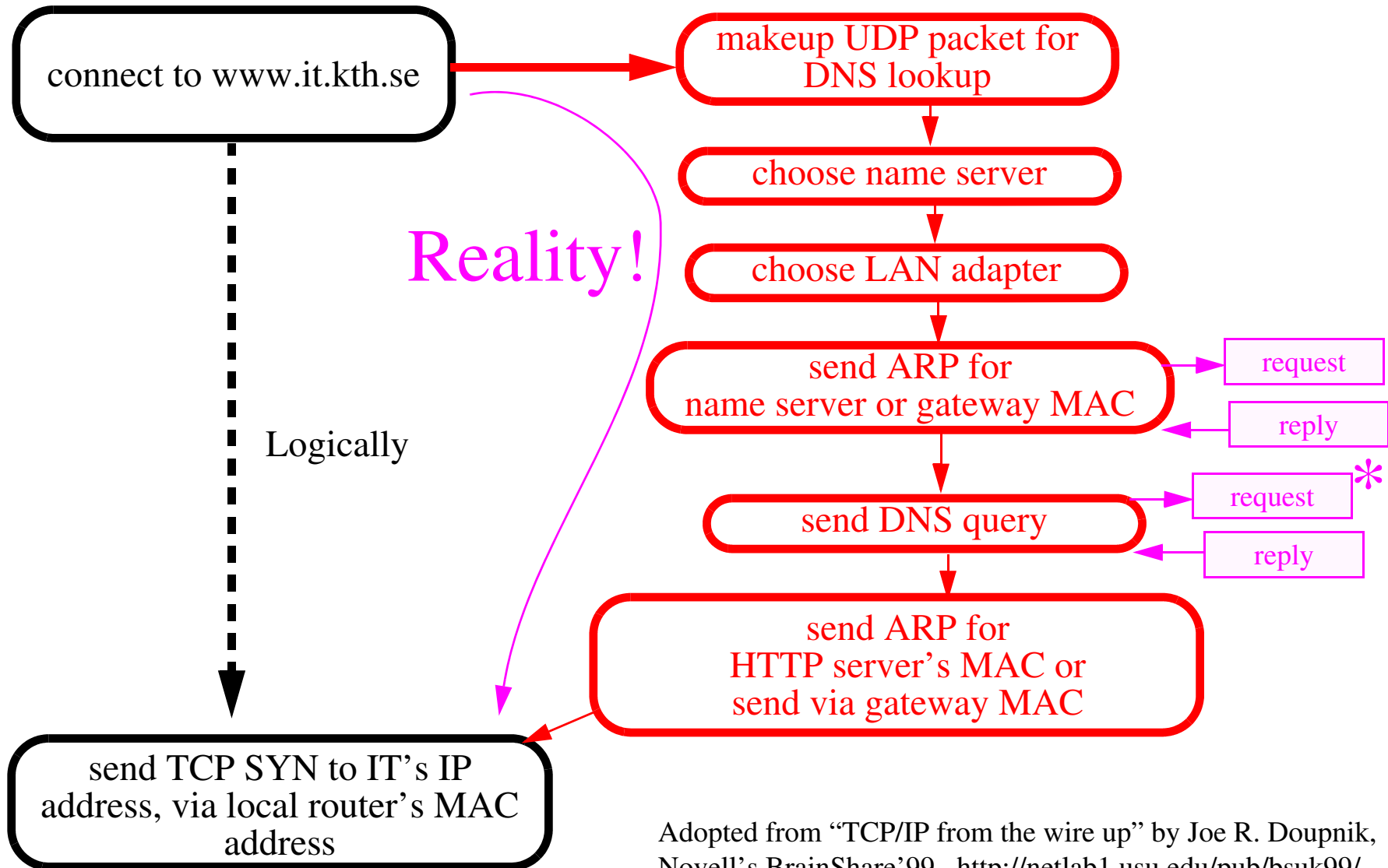

Adopted from "TCP/IP from the wire up" by Joe R. Douppnik, Novell's BrainShare'99. <http://netlab1.usu.edu/pub/bsuk99/>

# HTTP Performance Problems

HTTP opens one connection for **each** document.

- Each such connection involves slow start - which adds to the delay
- Each connection is normally closed by the HTTP server - which has to wait TIME\_WAIT, thus lots of control blocks are waiting in the server.

Proposed changes:

- have client and server keep a TCP connection open {this requires that the size of the response (Content-Length) be generated}
  - requires a change in client and server
  - new header Pragma: hold-connection
- GETALL - causes server to return document and all in-lined images in a single response
- GETLIST - similar to a client issuing a series of GETs
- HTTP-NG (aka HTTP/1.1) - a single TCP connection with multiple sessions {it is perhaps the first TCP/IP session protocol}
  - HTTP/1.1 also has another feature - the server knows what hostname was in the request, thus a single server at a single IP address can be the HTTP server under many “names” - hence providing “Web hotel” services for many firms but only using a single IP address.

# HTTP performance

Joe Touch, John Heidemann, and Katia Obraczka, “Analysis of HTTP Performance”, USC/Information Sciences Institute, August 16, 1996, Initial Release, V1.2 -- <http://www.isi.edu/lisam/publications/http-perf/>

John Heidemann, Katia Obraczka, and Joe Touch, “Modeling the Performance of HTTP Over Several Transport Protocols”, IEEE/ACM Transactions on Networking 5(5), October 1997. November, 1996.

<http://www.isi.edu/~johnh/PAPERS/Heidemann96a.html>

Simon E Spero, “Analysis of HTTP Performance problems”

<http://sunsite.unc.edu/mdma-release/http-prob.html> This is a nice introduction to HTTP performance.

John Heidemann, “Performance Interactions Between P-HTTP and TCP Implementations”. ACM Computer Communication Review, 27 2, 65-73, April, 1997. <http://www.isi.edu/~johnh/PAPERS/Heidemann97a.html>

# Web Enabled Devices

emWare - thin client (30 bytes of RAM, 750 bytes of ROM) - for a very thin client

URL: <http://www.emware.com/>

Splits the web server into a very tiny server on the device and more processing (via applets) in the desktop system (where the WEB browser is running).

Axis Communications AB - <http://www.axis.com> - produces many web enabled devices  
- from thin clients to “cameras” running an embedded Linux

# Network File System (NFS)

NFS is based on Sun's Remote Procedure Call (RPC) - RFC 1831

- from the caller's point of view it looks much like a local procedure call
- from the callee's point of view it seems much like a local procedure call
- Request-reply protocol
- UDP or TCP transport
- Standardized data representation - RPC encodes its data using the eXternal Data Representation (XDR) protocol, RFC 1832
- Authentication {for example, for NFS operations, authentication usually based on relaying UNIX user and group IDs to the file server for permission checking}



# Remote Procedure Call (RPC)

Two versions:

- using Sockets API and works with TCP and UDP
- using TLI API TI-RPC (Transport Independent) and works with any transport layer provided by the kernel

Format of an RPC call message as a UDP datagram

|                      |                |
|----------------------|----------------|
| IP Header            | 20 bytes       |
| UDP Header           | 8              |
| transaction ID (XID) | 4              |
| call (0)             | 4              |
| RPC version (2)      | 4              |
| program number       | 4              |
| version number       | 4              |
| procedure number     | 4              |
| credentials          | upto 400 bytes |
| verifier             | upto 400 bytes |
| procedure parameters | N              |

- XID set by client and returned by server (client uses it to match requests and replies)

- program number, program version, procedure number identifies the procedure to be called
- credentials identify the client - sometimes the user ID and group ID
- verifier - used with secure RPC (to identify the server); uses DES encryption

1

**Format of an RPC reply message as a UDP datagram**

|                      |                |
|----------------------|----------------|
| IP Header            | 20 bytes       |
| UDP Header           | 8              |
| transaction ID (XID) | 4              |
| call (1)             | 4              |
| status (0=accepted)  | 4              |
| verifier             | upto 400 bytes |
| procedure results    | N              |

# External Data Representation (XDR)

used to encode value in RPC messages - see RFC 1014

# Port Mapper

RPC server programs use ephemeral ports - thus we need a well known port to be able to find them

Servers register themselves with a registrar - the **port mapper** (called rpcbnd in SVR4 and other systems using TI-RPC)

Port mapper is at well know port: 111/UDP and 111/TCP

The port mapper is an RPC server with program number 100000, version 2, a TCP port of 111, a UDP port of 111.

Servers register themselves with RPC calls and clients query with RPC calls:

- PMAPPROC\_SET - register an entry
- PMAPPROC\_UNSET - unregister an entry
- PMAPPROC\_GETPORT - get the port number of a given instance
- PMAPPROC\_DUMP - returns all entries (used by “rpcinfo -p”)

# NFSspy

Insert a new pointer in place of the RPC we want to snoop

Embed this earlier code in our code:

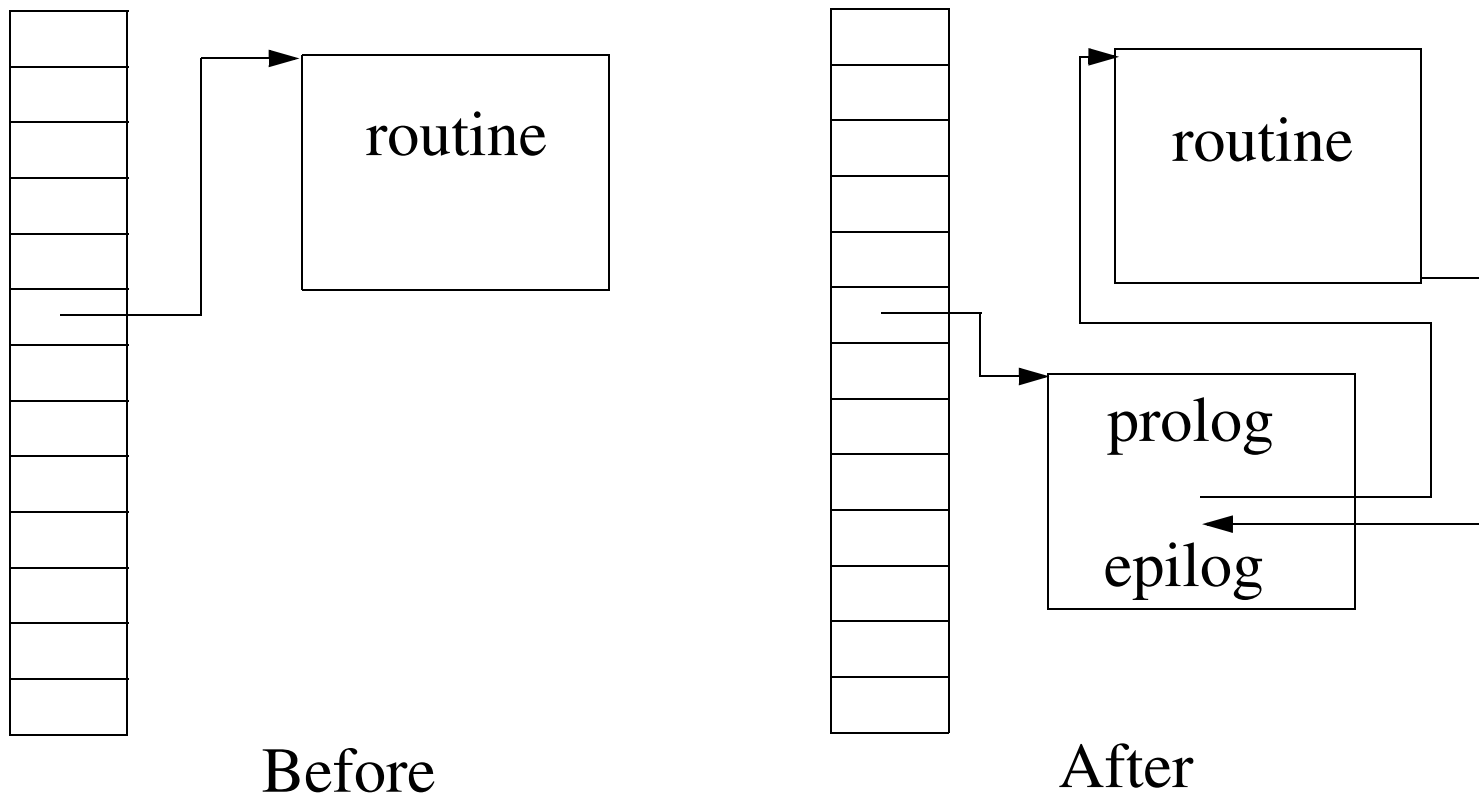

## NFSspy problem

Imagine several students each insert a new pointer in place of the RPC they want to snoop:

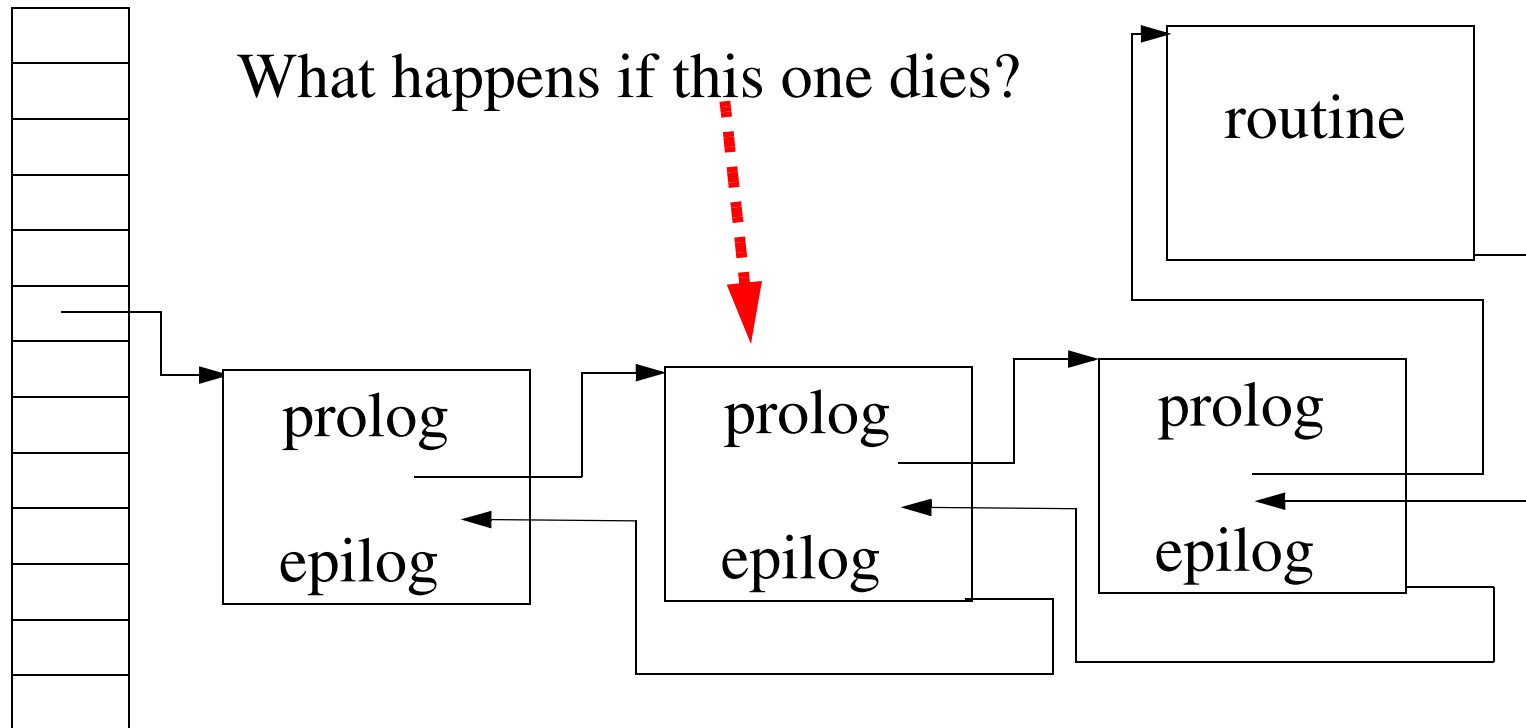

The routine is no longer callable by **anyone!**

## nfsspy

Initial implementations were written by Seth Robertson, Jon Helfman, Larry Ruedisueli, Don Shugard, and other students for a project assignment in my course on Computer Networks at Columbia Univ. in 1989. There is a report about one implementation by Jon Helfman, Larry Ruedisueli, and Don Shugard, "Nfs spy: A System for Exploring the Network File System", AT&T Bell Laboratories, 11229-890517-07TM.

See also “NFS Tracing By Passive Network Monitoring” by Matt Blaze, ~1992,

<http://www.funet.fi/pub/unix/security/docs/papers/nfsspy.ps.gz>

Matt’s program builds upon an rpcspy program and this feeds packets to his nfstrace program and other scripts.

Seth Robertson’s version even inverted the file handles to show the actual file names.

## NFS protocol, version 2 (RFC 1094)

- provides transparent file access
- client server application built on RPC

Generally, NFS server at 2049/UDP - but it can be at different ports

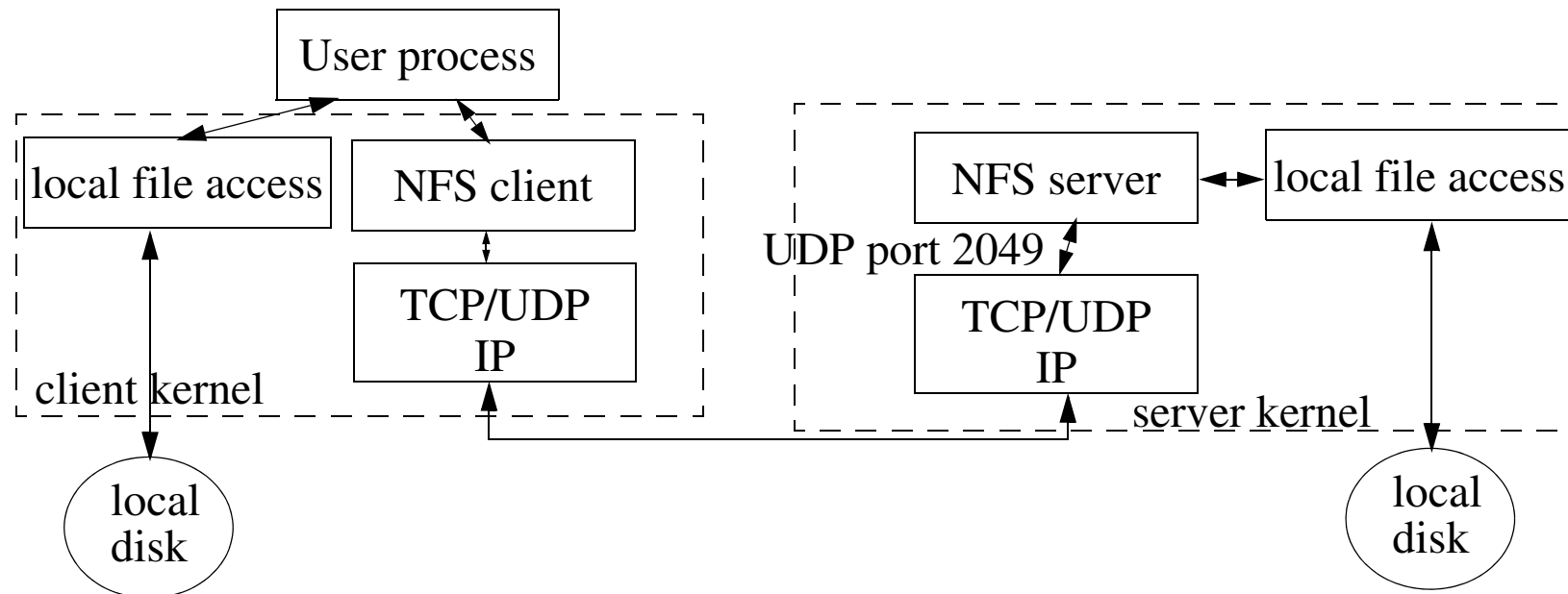

Figure 5: NFS client and NFS server (see Stevens, Vol. 1, figure 29.3, pg. 468)

Most NFS servers are multithreaded - so that multiple requests can be in process at one time. If the server kernel does not support multithreading then multiple server processes (“nfsd”) are used.



Often there are multiple NFS clients (“biod”) running on the client machine - each processes one call and waits inside the kernel for the reply.

## NFS consists of more than just the NFS protocol

Various RPC programs used with NFS (see Stevens, Vol. 1, pg. 469)

| Application    | program number | version numbers | Number of procedures |
|----------------|----------------|-----------------|----------------------|
| port mapper    | 100000         | 2               | 4                    |
| NFS            | 100003         | 2               | 15                   |
| mount          | 100005         | 1               | 5                    |
| lock manager   | 100021         | 1,2,3           | 19                   |
| status monitor | 100024         | 1               | 6                    |

lock manager and status monitor allow locking of portions of files

# NFS File Handles

To reference a file via NFS we need a **file handle**, an opaque object used to reference a file or directory on the server.

File handle is created by the server - upon an lookup; subsequent client requests just simply pass this file handle to the appropriate procedure (they never look at the contents of this object - hence it is opaque).

- in version 2, a file handle is 32 bytes
- in version 2, a file handle is 64 bytes

UNIX systems generally encode the filesystem ID (major and minor dev numbers), the i-node number, and an i-node generation number into the file handle.

# NFS Mount protocol

Server can check IP address of client, when it gets a mount command from a client to see if this client is allowed to mount the given filesystem; Mount daemon returns the file handle of the given filesystem.

# NFS Procedures

| Procedure        | Description   |
|------------------|---|
| NFSPROC_GETATTR  | return the attributes of a file   |
| NFSPROC_SETATTR  | set the attributes of a file  |
| NFSPROC_STATFS   | return the status of a filesystem   |
| NFSPROC_LOOKUP   | lookup a file - returns a file handle   |
| NFSPROC_READ     | read from a file, starting at specified offset for n bytes (upto 8192 bytes)  |
| NFSPROC_WRITE    | Write to a file, starting at specified offset for n bytes (upto 8192 bytes)<br>Writes are synchronous - i.e., server responds OK when file is actually written to disk<br>(this can often be changed as an option at mount time - but you can get into trouble) |
| NFSPROC_CREATE   | Create a file   |
| NFSPROC_REMOVE   | Delete a file   |
| NFSPROC_RENAME   | Rename a file   |
| NFSPROC_LINK     | make a hard link to a file  |
| NFSPROC_SYMLINK  | make a symbolic link to a file  |
| NFSPROC_READLINK | return the name of the file to which the symbolic link points   |
| NFSPROC_MKDIR    | create a directory  |
| NFSPROC_RMDIR    | delete a directory  |
| NFSPROC_READDIR  | read a directory  |

# NFS over TCP

Provided by some vendors for use over WANs.

- All applications on a given client share the same TCP connection.
- Both client and server set TCP keepalive timers
- If client detects that server has crashed or been rebooted, it tries to reconnect to the server
- if the client crashes, the client gets a new connection, the keepalive timer will terminate the half-open former connection

# NFS Statelessness

NFS is designed to be stateless

- the server does not keep track of what clients are accessing which files
- there are no open or close procedures; just LOOKUP
- being stateless simplifies server crash recovery
- clients don't know if the server crashes
- only the client maintains state

Most procedures (GETATTR, STATFS, LOOKUP, READ, WRITE, READDIR) are idempotent (i.e., can be executed more than once by the server with the same result).

Some (CREATE, REMOVE, RENAME, SYMLINK, MKDIR, RMDIR) are not. SETATTR is idempotent unless it is truncating a file.

To handle non-idempotent requests - most servers use recent-reply cache, checking their cache to see if they have already performed the operation and simply return the same value (as before).

# X Window System

- Client-server application that lets multiple clients share a bit-mapped display.
- One server manages the display, keyboard, mouse, ...
- X requires a reliable bidirectional bitstream protocol (such as TCP).
- The server does a passive open on port 6000+n, where n is the display number (usually 0)
- X can also use UNIX domain sockets (with the name /tmp/.X11-unix/Xn, where n is the display number)
- > 150 different messages in the X protocol (for details see Nye, 1992)

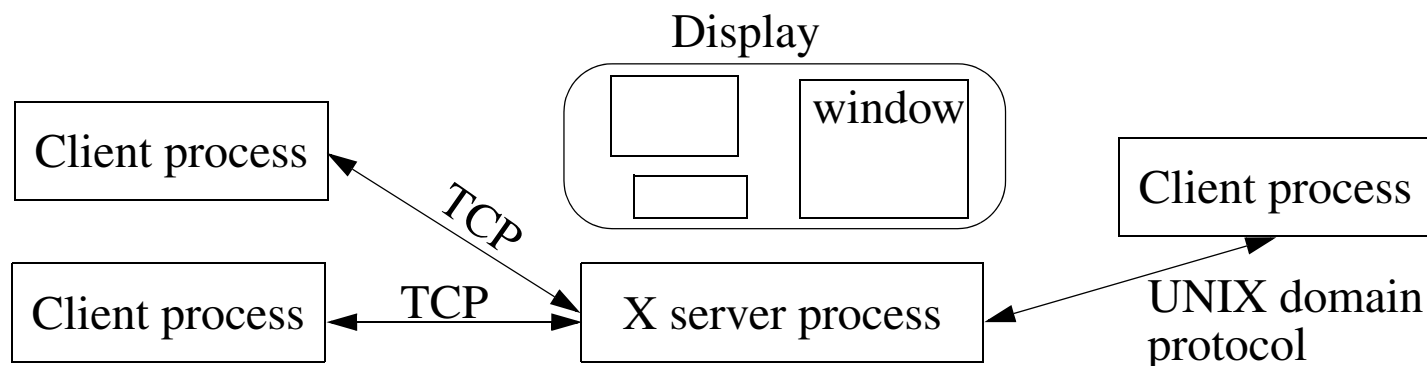

Figure 6: Clients using a X server to access one display

- All clients (even those on different hosts) communicate with the same server.
- Lots of data can be exchanged between client and server
  - xclock - send date and time once per second
  - Xterm - send each key stroke (a 32 byte X message  $\Rightarrow$  72 bytes with IP and TCP headers)
  - some applications read and write entire 32 bit per pixel images in cine mode from/to a window!



# Low Bandwidth X

X was optimized for use across LANs.

For use across low speed links - various techniques are used:

- caching
- sending differences from previous packets
- compression, ...

# Xscope

Interpose a process between the X server and X client to watch traffic.

For example, xscope could be run as if it were display “1”, while passing traffic to and from display “0”. See Stevens, Vol.1, pp. 488-489 for more details (or try running it!)

J.L. Peterson. XSCOPE: A Debugging and Performance Tool for X11. Proceedings of the IFIP 11th World Computer Congress, September, 1989, pp. 49-54.

See also XMON - An interactive X protocol monitor

Both are available from: <ftp://ftp.x.org/pub/R5/>

# Additional tools for watching TCP

| Program   | Description   |
|-----------|---|
| IPerf     | Measure bandwidth availability using a client and server. Determines total bandwidth, delay jitter, loss, determine MTU, support TCP window size, ...   |
| Pathchar  | Determine per hop network path characteristics (bandwidth, propagation delay, queue time and drop rate. It utilizes a series of packets with random payload sizes over a defined period of time to each hop in a path.                  |
| Pchar     | Updated version of Pathchar -- by Bruce Mah   |
| Netlogger | NetLogger includes tools for generating precision event logs that can be used for detailed end-to-end application & system level monitoring, and tools for visualizing log data to view the state of a distributed system in real time. |
| Treno     | Measure single stream bulk transfer capacity. TReno doesn't actually use TCP slow start, but instead emulates it. It actually sends UDP packets to unused ports and uses the returned error messages to determine the packet timing.    |
| Mping     | Measure queuing properties during heavy congestion  |
| tdg       | produce graphs of TCP connections from tcpdump files, suitable for use with xgraph. A perl script which produces time-sequence plots from tcpdump files.  |

| <b>Program</b> | <b>Description</b>  |
|----------------|---|
| tcptrace       | parses raw tcpdump files to extract information and xplot files.  |
| xplot          | generate graphs from plot data in X Windows.  |
| testrig        | automated connection diagnosis tool; generates a test flow & display a time sequence plot based on that flow. |
| aspath         | determine traffic usage by AS path.   |

# Transaction TCP (T/TCP)

Piggyback a query in the TCP open - so that you don't have to wait a long time for sending a query / response

# Summary

This lecture we have discussed:

- TCP
- HTTP
- Web enabled devices
- RPC, XDR, and NFS
- X Window System, and
- some tools for looking at these protocols

# References

- [1] Information Sciences Institute, University of Southern California, Transmission Control Protocol, IETF, RFC 793, September 1981

# IK1550 Internetworking/Internetteknik

## Spring 2010, Period 4

### Module 6: SCTP

Lecture notes of G. Q. Maguire Jr.



**KTH Information and  
Communication Technology**

© 2010 G.Q.Maguire Jr. .

All rights reserved. No part of this course may be reproduced, stored in a retrieval system, or transmitted, in any form or by any means, electronic, mechanical, photocopying, recording, or otherwise, without written permission of the author.

Last modified: 2010.03.21:17:34



# Transport layer protocols

- User Datagram Protocol (UDP)
  - Connectionless **unreliable** service
- Transmission Control Protocol (TCP)
  - Connection-oriented **reliable stream** service
- Stream Control Transmission Protocol (SCTP) <<< **today's topic**
  - **Reliable message oriented** service - a modern transmission protocol

# Stream Control Transmission Protocol (SCTP) [3]

Provides a **reliable message-oriented** service; combining best of TCP & UDP.

- SCTP utilizes full-duplex **associations**
- SCTP applications write messages to one of several **streams** and read messages from these streams
  - each unit is a **chunk**
  - here are record makers  $\Rightarrow$  the receiver **can** tell how much the sender wrote into the stream at any given time
  - **multiple streams** prevents a loss on one stream from affecting other streams
- SCTP supports **multihoming**
  - the sender and receiver can utilize multiple interfaces with multiple IP addresses  $\Rightarrow$  increased fault tolerance
  - current implementations do **not** support *load balancing* (i.e., only supports failover)
- SCTP provides **reliability**
  - via acknowledgements, timeouts, retransmission, ...
- SCTP provides **flow control**
- SCTP tries to **avoid** causing **congestion**

# SCTP Applications

- Initial goal of IETF Sigtran WG was to support SS7 applications over IP
  - For example, SMS transfer!
  - For an example see [1], [5]
- new applications being developed to use SCTP
  - SIP over SCTP
  - HTTP over SCTP
  - recommended transport protocol for DIAMETER
- Strong security can be provided via TLS [12]

# SCTP Header

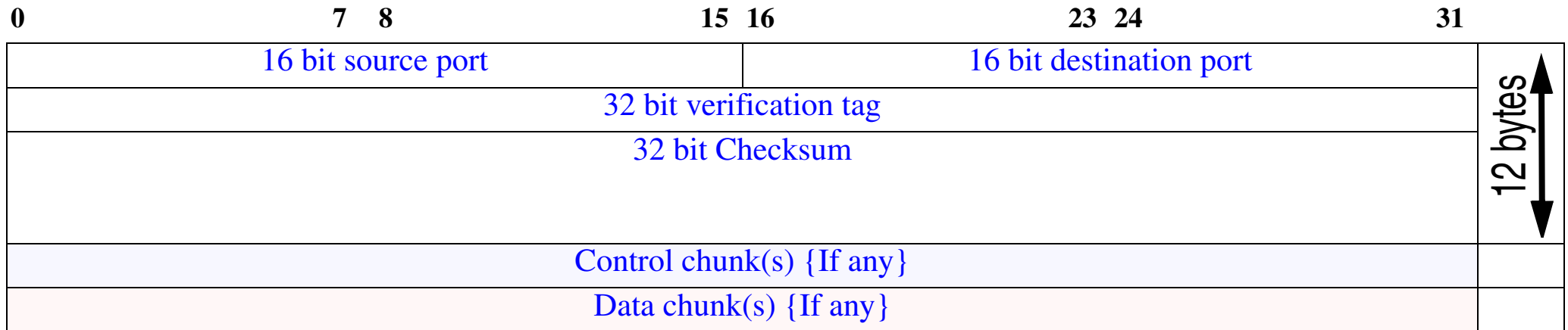

Figure 1: SCTP packet (see Forouzan figure 13.4 pg. 350)

IP protocol x84 = SCTP

- **General Header**

- As with UDP & TCP, SCTP provides [de/multiplexing](#) via the 16 bit source and destination ports.
- [Associations](#) between end points are defined by a unique **verification tag**
  - A separate verification tag is used in each direction
- SCTP applies a CRC-32 end-to-end [checksum](#) to its general header and all the chunks
  - Previously it used Adler-32 checksum [11]

- **Chunks**

- Control information is contained in [Control Chunks](#) (these always **precede** any data chunks)
- Multiple [data chunks](#) can be present - each containing data for different streams

# SCTP Chunk

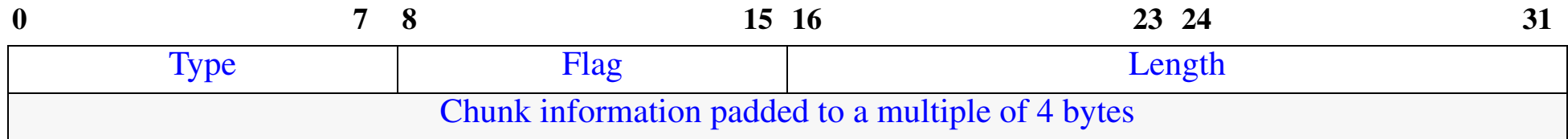

Figure 2: SCTP packet (see Forouzan figure 13.8 pg. 354)

- Type

| Type | Chunk         | Description                          | Type | Chunk             | Description                                     |
|------|---------------|--------------------------------------|------|-------------------|---|
| 0    | DATA          | User data                            | 7    | SHUTDOWN          | Terminate an association                        |
| 1    | INIT          | Setup an association                 | 8    | SHUTDOWN-ACK      | Acknowledge SHUTDOWN chunk                      |
| 2    | INIT-ACK      | Acknowledge an INIT chunk            | 9    | ERROR             | Reports errors without shutting down            |
| 3    | SACK          | Selective Acknowledgement            | 10   | COOKIE ECHO       | Third packet in establishment of an association |
| 4    | HEARTBEAT     | Probe to see if peer is alive        | 11   | COOKIE ACK        | Acknowledges COOKIE ECHO chunk                  |
| 5    | HEARTBEAT-ACK | Acknowledgement of a HEARTBEAT chunk | 14   | SHUTDOWN COMPLETE | Third packet in an association terminations     |
| 6    | ABORT         | Abort an association                 | 192  | FORWARD TSN       | To adjust the cumulative TSN                    |

- Flag - 8 bit field defined per chunk type
- Length - 16 bit length of chunk including chunk header (i.e., smallest value is 4) - does **not** include any padding bytes (hence you know just how much padding there is)

# Association establishment - 4-way handshake

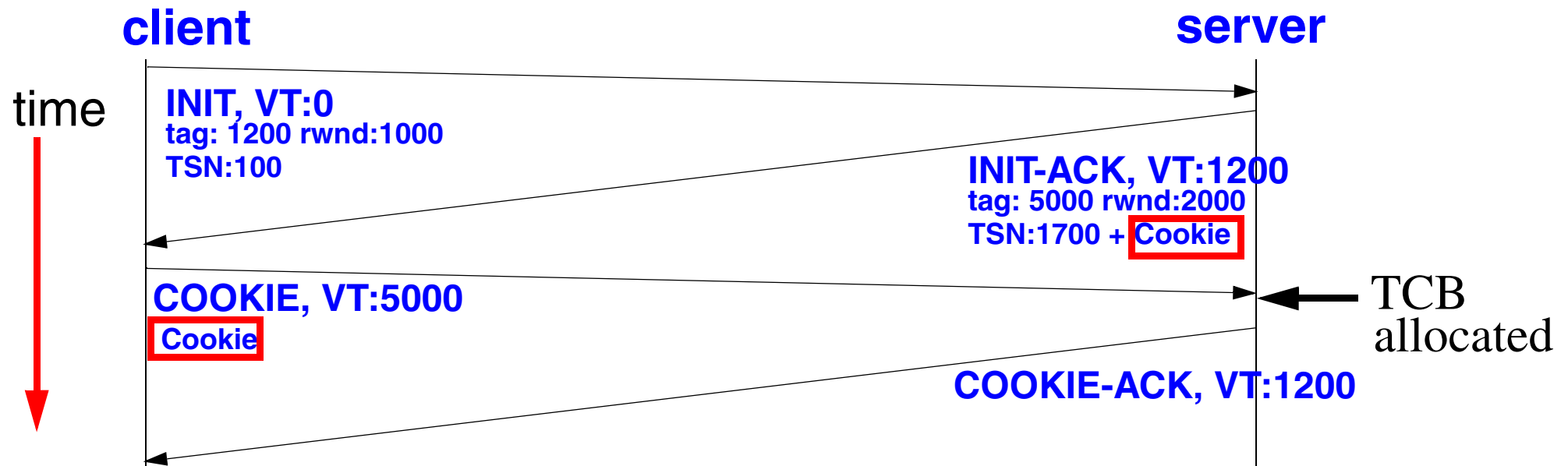

See Forouzan figure 13.19 page 363

The entity initiating the connection is (normally) called the "client" and does an active open, whereas the server needed to previously do a passive open.

# INIT Chunk

|  |   |          |    |                         |        |    |    |
|--|---|----------|----|-------------------------|--------|----|----|
| 0  | 7 | 8        | 15 | 16                      | 23     | 24 | 31 |
| Type = 1                                   |   | Flag = 0 |    |                         | Length |    |    |
| Initiation tag                             |   |          |    |                         |        |    |    |
| Advertised receiver window credit (rwnd)   |   |          |    |                         |        |    |    |
| Outbound streams                           |   |          |    | Maximum inbound streams |        |    |    |
| Initial Transmission sequence number (TSN) |   |          |    |                         |        |    |    |
| variable-length parameters (optional)      |   |          |    |                         |        |    |    |

Figure 3: SCTP INIT chunk (see Forouzan figure 13.10 pg. 357)

- **Initiation tag**
  - defines the tags for this association to be used by the other party
  - reduce the risk due to a blind attacker (since there is only a 1 in  $2^{32}$  chance of guessing the right tag)
  - can reject delayed packets - thus avoiding the need for TCP's TIME-WAIT timer
- **Advertised receiver window credit**
  - defines rwnd (i.e., how much the receiver can send to this party)
- **Outbound streams**
  - suggested upper number of streams **from** this sender (can be reduced by receiver)
- **Maximum inbound streams**
  - upper limit of streams **to** this sender

- **Transmission sequence number (TSN)**
  - Initializes the TSN in the outbound direction, initialized to a random value
- **Variable-length parameters**
  - IP address(es) of endpoint
    - Multiple addresses are used to support multihoming
    - The **receiver** selects the primary address for the other endpoint
  - Type of addresses
  - Support for Explicit Congestion Notification (ECN)
  - ...



# INIT ACK Chunk

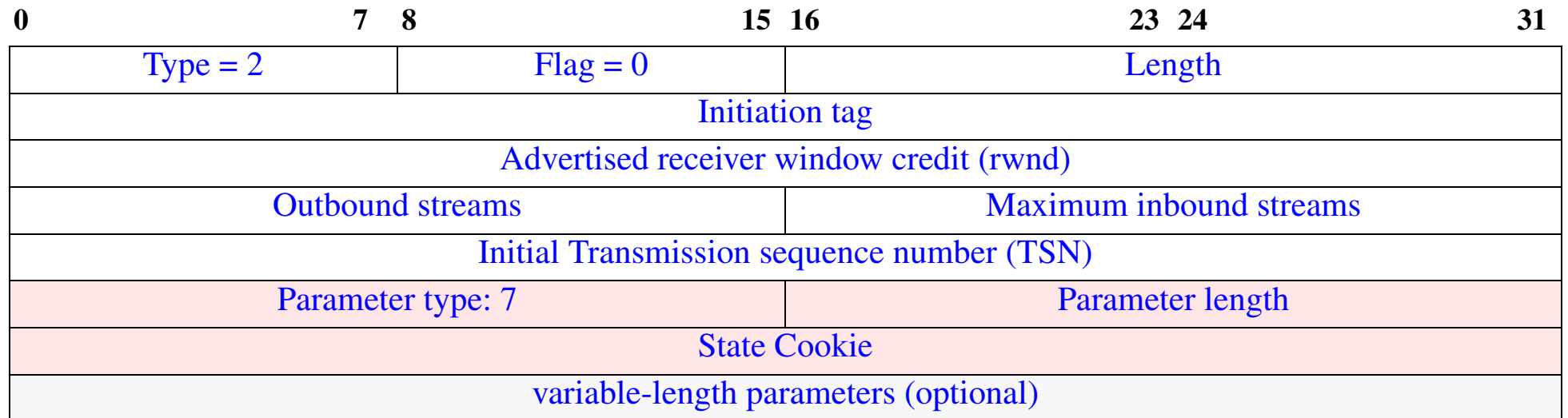

Figure 4: SCTP INIT ACK chunk (see Forouzan figure 13.11 pg. 358)

The same fields as in the INIT chunk (with **Initiation tag** value set to that of the INIT) - but with the addition of a **required parameter** with a state cookie.

- **Parameter type: 7 = State Cookie**
- **Parameter length = size of State Cookie + 4 (the parameter type and length fields)**

A packet carrying this INIT ACK chunk can not contain any other control or data chunks.

# State Cookie

Use of the COOKIE prevents a SYN flood like attack - since resources are not allocated until the COOKIE ECHO chunk is received.

However, state has to be saved from the initial INIT chunk - therefore it is placed in the cookie in a way that only the server can access it (hence the cookie is sealed with an HMAC {aka digest} after being created {aka “baked”}). This requires that the server has a secret key which it uses to compute this digest.

If the sender of the INIT is an attacker located on another machine, they won't be able to receive the cookie if they faked the source address in the INIT - since the INIT ACK is sent to the address and contains the cookie!

- Without a cookie  $\Rightarrow$  no association is created and no resources (such as TCB) are tied up!

# COOKIE ECHO Chunk

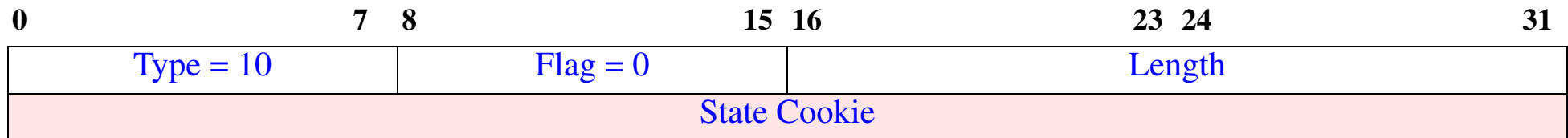

Figure 5: SCTP COOKIE ECHO chunk (see Forouzan figure 13.12 pg. 359)

- (chunk) Type: 10 = COOKIE ECHO
- (chunk) length = size of State Cookie + 4 (the parameter type and length fields)
- State Cookie
  - simply a copy of the COOKIE data from the INIT ACK chunk
  - The COOKIE data is opaque (i.e., only the sender can read the cookie)

A packet carrying this COOKIE ECHO chunk can contain other control or data chunks -- in particular it can carry the first user (client) data!

# COOKIE ACK Chunk

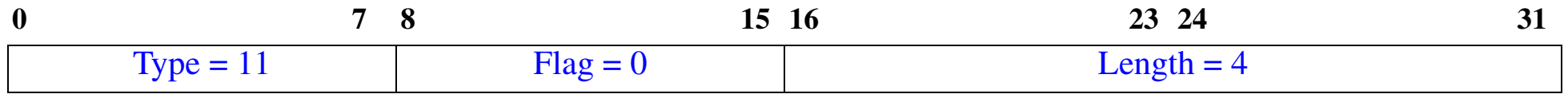

Figure 6: Sctp COOKIE ACK chunk (see Forouzan figure 13.13 pg. 359)

Completes the 4 way handshake.

A packet with this chunk can also carry control and data chunks (in particular the first of the user (server) data).

# Data Chunk

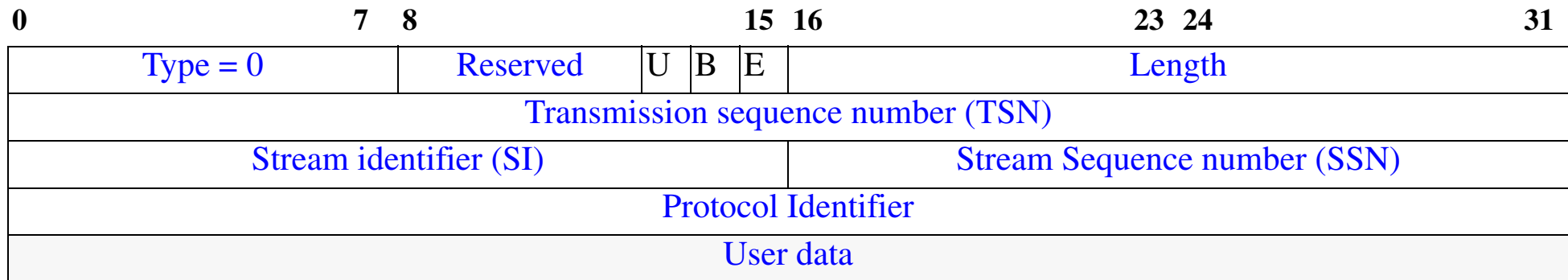

Figure 7: SCTP Data Chunk (see Forouzan figure 13.9 pg. 356)

- **Flags:**
  - U - Unordered - for delivery to the application right away
  - B - Beginning (chunk position - for use with fragmentation)
  - E - End chunk
- **Transmission sequence number (TSN)**- only data chunks consume TSNs
- **Stream identifier (SI)**
- **Stream Sequence number (SSN)**
- **Protocol Identifier**
- **User data**
  - at least 1 byte of user data; padded to 32 bit boundaries
  - although a message can be spread over multiple chunks, each chunk contains data from **only** a single message (like UDP, each message results in one or more data SCTP chunks)

# Multiple-Streams

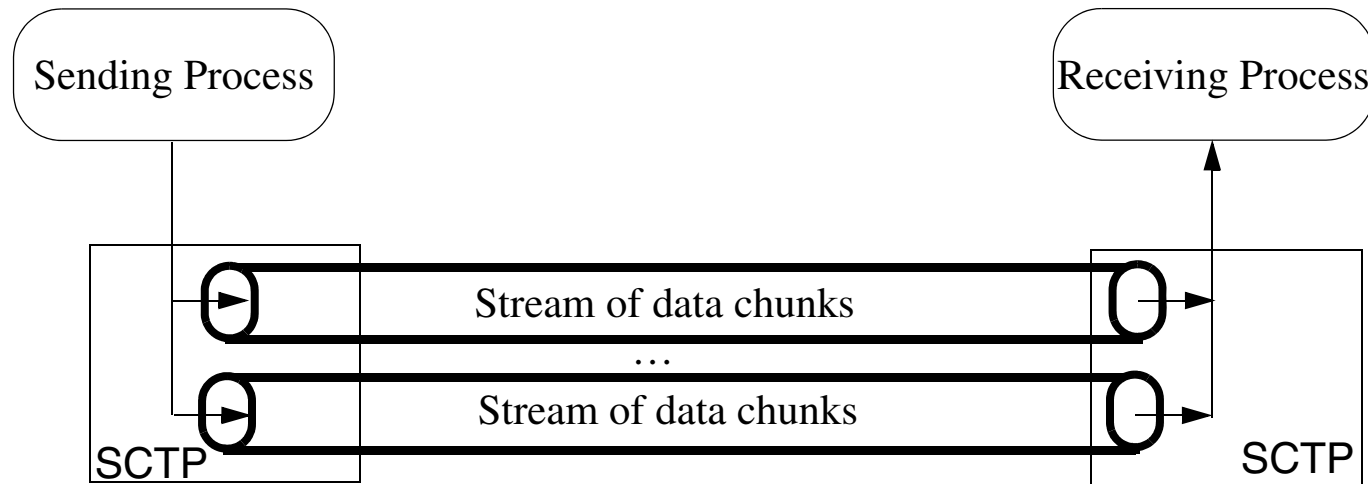

Figure 8: Multiple-streams (see Forouzan figure 13.2 pg. 347)

The figure above shows a **single** association.

Each stream has a unique **stream identifier** (SI) and maintains its own **stream sequence number** (SSN).

**Unordered** data chunks (i.e., with  $U = 0$ ) - do **not** consume a SSN and are delivered when they arrive at the destination.

Multiple streams and unordered data avoid TCP's **head of line blocking**.

# Selective Acknowledgement (SACK) Chunk

|                                   |     |          |                                 |        |
|-----------------------------------|-----|----------|---------------------------------|--------|
| 0                                 | 7 8 | 15 16    | 23 24                           | 31     |
| Type = 3                          |     | Flag = 0 |                                 | Length |
| cumulative TSN acknowledgement    |     |          |                                 |        |
| Advertised receiver window credit |     |          |                                 |        |
| Number of gap ACK blocks: N       |     |          | Number of duplicates: M         |        |
| Gap ACK block #1 start TSN offset |     |          | Gap ACK block #1 end TSN offset |        |
| ...                               |     |          | ...                             |        |
| Gap ACK block #N start TSN offset |     |          | Gap ACK block #N end TSN offset |        |
| Duplicate TSN 1                   |     |          |                                 |        |
| ...                               |     |          |                                 |        |
| Duplicate TSN M                   |     |          |                                 |        |

Figure 9: SCTP Data Chunk (see Forouzan figure 13.9 pg. 356)

- Cumulative Transmission sequence number (TSN) acknowledgement - the last data chunk received **in sequence**
- Gap = received sequence of chunks (indicated with start .. end TSNs)
- Duplicate TSN - indicating duplicate chunks (if any)
- SACK always sent to the IP address where the corresponding packet originated

# ERROR chunk

Sent when an endpoint finds some error in a packet

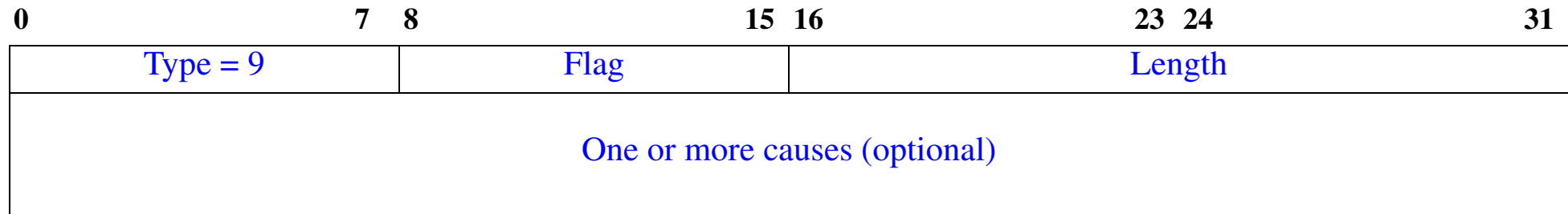

Figure 10: SCTP ERROR chunk (see Forouzan figure 13.17 pg. 361)

| Error code | Description                         |
|------------|-------------------------------------|
| 1          | Invalid Stream identifier           |
| 2          | Missing mandatory parameter         |
| 3          | State cookie error                  |
| 4          | Out of resource                     |
| 5          | Unresolvable address                |
| 6          | Unrecognized chunk type             |
| 7          | Invalid mandatory parameters        |
| 8          | Unrecognized parameter              |
| 9          | No user data                        |
| 10         | Cookie received while shutting down |



# Association Termination

Two forms of termination

- **Association Abort**
  - Used in the event of a fatal error
  - uses same error codes as the ERROR Chunk
  - Chunk format

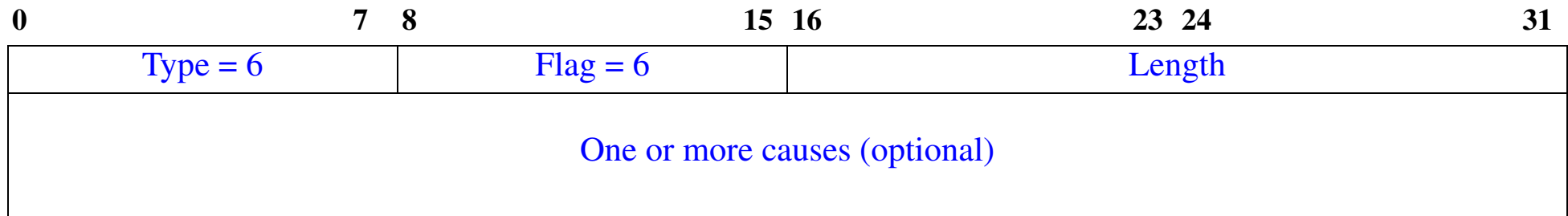

Figure 11: SCTP ABORT chunk (see Forouzan figure 13.18 pg. 362)

- **Association Shutdown - graceful termination**

# Association Shutdown

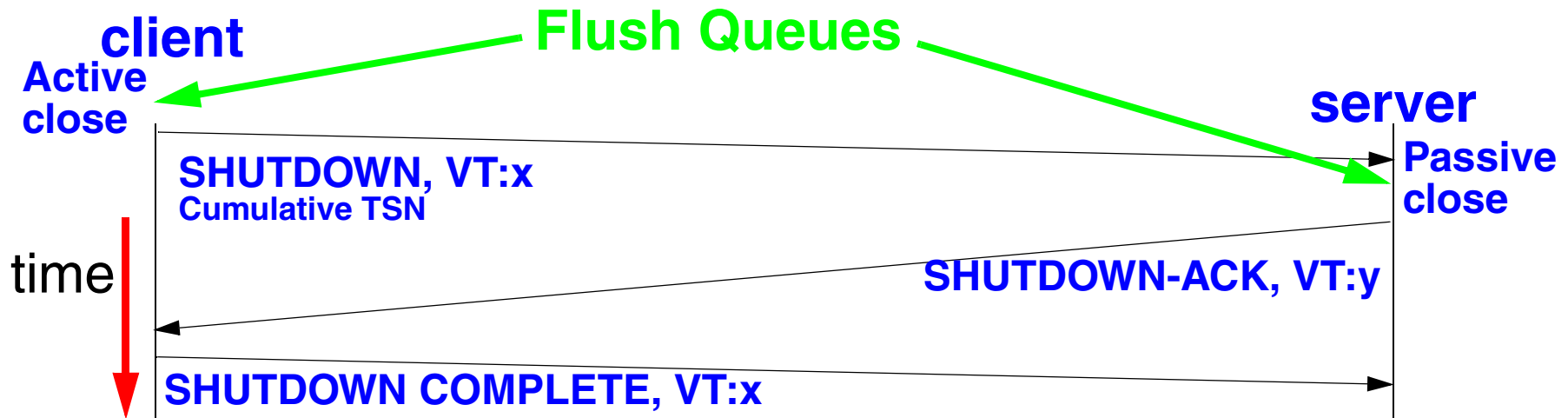

Figure 12: Adapted from Forouzan figure 13.21 page 368 and slide 15 of [2]

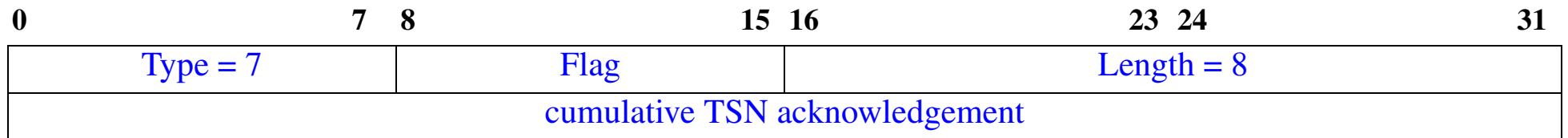

Figure 13: SCTP SHUTDOWN chunk (see Forouzan figure 13.16 pg. 361)

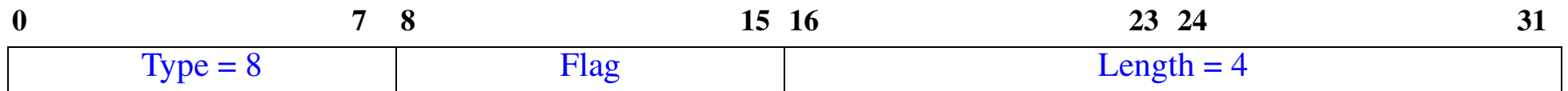

Figure 14: SCTP SHUTDOWN ACK chunk (see Forouzan figure 13.16 pg. 361)

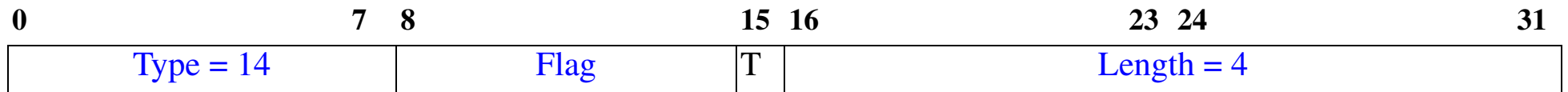

Figure 15: SCTP SHUTDOWN COMPLETE chunk (see Forouzan figure 13.16 pg. 361)

- T bit indicates the sender did **not** have a Transmission Control Block (TCB)

# SCTP Example - Daytime [6]

```
server# ./daytime_server -s 192.168.1.2 -vv
1      : Communication up (1 paths)
1      : Network status change: path 0 is now REACHABLE
1      : Shutdown complete

client# ./terminal -vv -r 13 -d 192.168.1.2 -s 192.168.1.1
1      : Communication up (1 paths, 1 In-Streams, 1 Out-Streams)
1      : Network status change: path 0 (towards 192.168.1.2) is now REACHABLE
Wed Apr 27 11:52:04 2005
1      : Shutdown received
```

|    |           |             |             |      |                   |
|----|-----------|-------------|-------------|------|-------------------|
| 11 | 74,864232 | 192.168.1.1 | 192.168.1.2 | SCTP | INIT              |
| 12 | 74,864552 | 192.168.1.2 | 192.168.1.1 | SCTP | INIT_ACK          |
| 13 | 74,864808 | 192.168.1.1 | 192.168.1.2 | SCTP | COOKIE_ECHO       |
| 14 | 74,865073 | 192.168.1.2 | 192.168.1.1 | SCTP | COOKIE_ACK        |
| 15 | 74,865273 | 192.168.1.2 | 192.168.1.1 | SCTP | DATA              |
| 16 | 74,865733 | 192.168.1.1 | 192.168.1.2 | SCTP | SACK              |
| 17 | 74,865933 | 192.168.1.2 | 192.168.1.1 | SCTP | SHUTDOWN          |
| 18 | 74,866132 | 192.168.1.1 | 192.168.1.2 | SCTP | SHUTDOWN_ACK      |
| 19 | 74,866195 | 192.168.1.2 | 192.168.1.1 | SCTP | SHUTDOWN_COMPLETE |

Figure 16: SCTP Daytime example - output from Ethereal

# ethereal capture - daytime - INIT

Frame 11 ...

Stream Control Transmission Protocol

Source port: 10777

Destination port: 13

Verification tag: 0x00000000

Checksum: 0x2b84fdb0<sup>1</sup>

INIT chunk (Outbound streams: 10, inbound streams: 10)

Chunk type: INIT (1)

Chunk flags: 0x00

Chunk length: 32

Initiate tag: 0x43d82c5d

Advertised receiver window credit (a\_rwnd): 131071

Number of outbound streams: 10

Number of inbound streams: 10

Initial TSN: 771212194

Forward TSN supported parameter

Parameter type: Forward TSN supported (0xc000)

Parameter length: 4

...

Supported address types parameter (Supported types: IPv4)

Parameter type: Supported address types (0x000c)

Parameter length: 6

Supported address type: IPv4 address (5)

---

1. Ethereal complains about this checksum saying “(incorrect Adler32, should be 0x973b078d)”, but this is in error see [11].

# ethereal capture - daytime - INIT-ACK

Frame 12 ... Stream Control Transmission Protocol

```
Source port: 13
Destination port: 10777
Verification tag: 0x43d82c5d
Checksum: 0x7f61f237
INIT_ACK chunk (Outbound streams: 1, inbound streams: 1)
  Chunk type: INIT_ACK (2)
  Chunk flags: 0x00
  Chunk length: 128
  Initiate tag: 0x5d581d9a
  Advertised receiver window credit (a_rwnd): 131071
  Number of outbound streams: 1
  Number of inbound streams: 1
  Initial TSN: 1514529259
  State cookie parameter (Cookie length: 100 bytes)
    Parameter type: State cookie (0x0007)
    Parameter length: 104
    State cookie: 5D581D9A0001FFFF000100015A45E1EB...
  Forward TSN supported parameter
    Parameter type: Forward TSN supported (0xc000)
    1... .. = Bit: Skip parameter and con-
tinue processing of the chunk
    .1.. .. = Bit: Do report
    Parameter length: 4
```

# ethereal capture - daytime - COOKIE-ECHO

Frame 13 ...

```
Source port: 10777
Destination port: 13
Verification tag: 0x5d581d9a
Checksum: 0x3af3f579
COOKIE_ECHO chunk (Cookie length: 100 bytes)
  Chunk type: COOKIE_ECHO (10)
    0... .. = Bit: Stop processing of the packet
    .0.. .. = Bit: Do not report
  Chunk flags: 0x00
  Chunk length: 104
  Cookie: 5D581D9A0001FFFF000100015A45E1EB...
```

# ethereal capture - daytime - COOKIE-ACK

Frame 14 ...

```
Source port: 13
Destination port: 10777
Verification tag: 0x43d82c5d
Checksum: 0x762d80d7
COOKIE_ACK chunk
  Chunk type: COOKIE_ACK (11)
  Chunk flags: 0x00
  Chunk length: 4
```



# ethereal capture - daytime - DATA

Frame 15 ...

```
Source port: 13
Destination port: 10777
Verification tag: 0x43d82c5d
Checksum: 0xf8fb1754
DATA chunk(ordered, complete segment, TSN: 1514529259, SID: 0,
SSN: 0, PPID: 0, payload length: 25 bytes)
  Chunk type: DATA (0)
  Chunk flags: 0x03
    .... ...1 = E-Bit: Last segment
    .... ..1. = B-Bit: First segment
    .... .0.. = U-Bit: Ordered delivieriy
  Chunk length: 41
  TSN: 1514529259
  Stream Identifier: 0x0000
  Stream sequence number: 0
  Payload protocol identifier: not specified (0)
  Chunk padding: 000000
```

Data (25 bytes)

```
0000 57 65 64 20 41 70 72 20 32 37 20 31 31 3a 34 33   Wed Apr 27 11:43
0010 3a 32 32 20 32 30 30 35 0a                        :22 2005.
```

# ethereal capture - daytime - SACK

Frame 16 ...

Source port: 10777

Destination port: 13

Verification tag: 0x5d581d9a

Checksum: 0xfa994e35

SACK chunk (Cumulative TSN: 1514529259, a\_rwnd: 131071, gaps: 0,  
duplicate TSNs: 0)

Chunk type: SACK (3)

Chunk flags: 0x00

Chunk length: 16

Cumulative TSN ACK: 1514529259

Advertised receiver window credit (a\_rwnd): 131071

Number of gap acknowledgement blocks : 0

Number of duplicated TSNs: 0

# ethereal capture - daytime - SHUTDOWN

Frame 17 ...

```
Source port: 13
Destination port: 10777
Verification tag: 0x43d82c5d
Checksum: 0xf447d00f
SHUTDOWN chunk (Cumulative TSN ack: 771212193)
  Chunk type: SHUTDOWN (7)
  Chunk flags: 0x00
  Chunk length: 8
  Cumulative TSN Ack: 771212193
```

# ethereal capture - daytime - SHUTDOWN\_ACK

Frame 18

```
Source port: 10777
Destination port: 13
Verification tag: 0x5d581d9a
Checksum: 0x9f44d056
SHUTDOWN_ACK chunk
  Chunk type: SHUTDOWN_ACK (8)
  Chunk flags: 0x00
  Chunk length: 4
```

# ethereal capture - daytime - SHUTDOWN\_COMPLETE

Frame 19...

```
Source port: 13
Destination port: 10777
Verification tag: 0x43d82c5d
Checksum: 0x3db6e771
SHUTDOWN_COMPLETE chunk
  Chunk type: SHUTDOWN_COMPLETE (14)
  Chunk flags: 0x00
    .... .0 = T-Bit: TCB destroyed
  Chunk length: 4
```

# Fault Management

- Endpoint Failure Detection

- Endpoint keeps a counter of the total number of consecutive retransmissions to its peer (including retransmissions to all the destination transport addresses [= port + IP address] of the peer if it is multi-homed). When this counter exceeds 'Association.Max.Retrans', the endpoint will consider the peer endpoint unreachable and shall stop transmitting any more data to it (the association enters the CLOSED state).
- Counter is reset each time:
  - a DATA chunk sent to that peer is acknowledged (by the reception of a SACK) or
  - a HEARTBEAT-ACK is received from the peer

- Path Failure Detection

- Each time (1) T3-rtx timer expires on any address or (2) a HEARTBEAT sent to an idle address is not acknowledged within a RTO, then the error counter of that destination will be incremented. When this error counter exceeds 'Path.Max.Retrans' for that destination address, then the endpoint marks the destination transport address as inactive and notifies the upper layer.
- the endpoint clears the error counter of this destination transport address when:
  - an outstanding TSN is acknowledged or
  - a HEARTBEAT address is acknowledged
- When the primary path is marked **inactive**, then the sender **may** automatically transmit new packets to an alternate destination address if one exists and is active
  - If more than one alternate address is active  $\Rightarrow$  only **one** transport address is chosen as the new destination transport address.

# HEARTBEAT and HEARTBEAT ACK Chunks

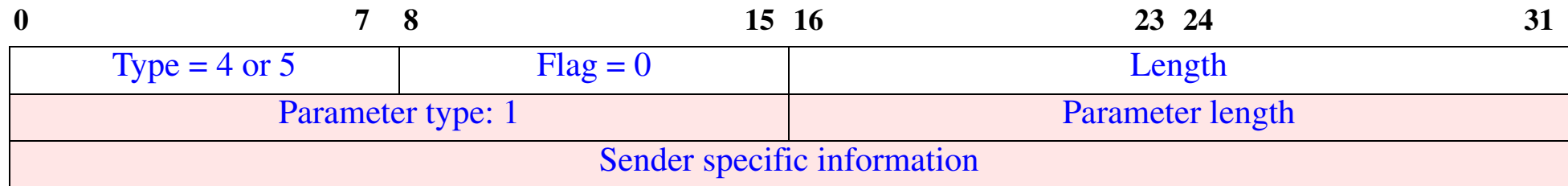

Figure 17: SCTP HEARTBEAT and HEARTBEAT ACK chunks (see Forouzan figure 13.15 pg. 360)

- (chunk) Type: 4 = HEARTBEAT
- (chunk) Type: 5 = HEARTBEAT ACK
- (chunk) length = size of sender specific information + 4 (the parameter type and length fields)
- Sender specific information
  - The sender puts its Local time and transport address in (note that the sctplib implementation 1.0.2 puts the time in as an unsigned 32 bit integer and puts the path index in (also as an unsigned 32 bit integer) and add a HMAC computed over these values [6])
  - The acknowledgement simply contains a copy of this information

Heartbeats every ~30 seconds.

# Heartbeat and ACK

Frame x ...

Source port: 9

Destination port: 38763

Verification tag: 0x36fab554

Checksum: 0x0e6c8d88 (incorrect Adler32, should be 0xf5340ec5)

HEARTBEAT chunk (Information: 28 bytes)

Chunk type: HEARTBEAT (4)

Chunk flags: 0x00

Chunk length: 32

Heartbeat info parameter (Information: 24 bytes)

Parameter type: Heartbeat info (0x0001)

Parameter length: 28

Heartbeat information: 0280351E00000000E1A06CFBC1C6933F...

Source port: 38763

Destination port: 9

Verification tag: 0x57c3a50c

Checksum: 0xaa2fba80 (incorrect Adler32, should be 0xe7450e58)

HEARTBEAT\_ACK chunk (Information: 28 bytes)

Chunk type: HEARTBEAT\_ACK (5)

Chunk flags: 0x00

Chunk length: 32

Heartbeat info parameter (Information: 24 bytes)

Parameter type: Heartbeat info (0x0001)

Parameter length: 28

Heartbeat information: 0280351E00000000E1A06CFBC1C6933F...



# Differences from TCP Congestion Control

- Any DATA chunk that has been acknowledged by SACK, including DATA that arrived out of order, are **only** considered fully delivered when the Cumulative TSN Ack Point passes the TSN of the DATA chunk
- ⇒ cwnd controls the amount of outstanding data, rather than (as in the case of non-SACK TCP) the upper bound between the highest acknowledged sequence number and the latest DATA chunk that can be sent within the congestion window
- ⇒ different fast-retransmit & fast-recovery than non-SACK TCP
- Retransmission based on both retransmission timer (with an RTO per path)
  - Three SACKS (i.e., 4 consecutive duplicate SACKs indicating missing chunks) • immediate retransmission of these missing chunks

## Sender

- uses the same destination address until instructed by the upper layer (however, SCTP may change to an alternate destination in the event an address is marked inactive) ⇒ retransmission can be to a different transport address than the original transmission.
- keeps separate congestion control parameters (cwnd, ssthresh, and partial\_bytes\_acked) for each of the destination addresses it can send to (i.e., not each source-destination pair)
  - these parameters should decay if the address is not used
  - does **slow-start** upon the **first** transmission to each of destination addresses

# Path MTU Discovery

- IPv4
  - Based on RFC 1191 [8] each endpoint maintains an estimate of the maximum transmission unit (MTU) along a **each** path and refrains from sending packets along that path which exceed the MTU, other than occasional attempts to probe for a change in the Path MTU (PMTU).
- IPv6
  - Based on RFC1981 [9] an SCTP sender using IPv6 **must** use Path MTU Discovery, unless all packets are less than the minimum IPv6 MTU (see RFC 2460 [10]).

SCTP differs in several ways from the description in RFC 1191 of applying MTU discovery to TCP:

- 1 SCTP associations can span multiple addresses  $\Rightarrow$  an endpoint does PMTU discovery on a [per-destination-address](#) basis
  - The term “MTU” always refers to the MTU associated with the destination address
- 2 Since SCTP does not have a notion of “Maximum Segment Size”, for each destination  $MTU_{initial} \leq MTU_{link}$  for the local interface to which packets for that remote destination address will be routed

- 3 When retransmitting to a remote address for which the IP datagram appears too large for the path MTU to that address, the IP datagram **should** be retransmitted without the DF bit set, enabling it to be fragmented. While *initial* transmissions of IP datagrams **must** have DF set.
- 4 Sender maintains an **association PMTU** (= smallest PMTU discovered for all of the peer's destination addresses); when fragmenting messages this association PMTU is used to calculate the size of each fragment  $\Rightarrow$  retransmissions can be sent to an alternate address without encountering IP fragmentation

# SCTP header continued

- **Reliability** is provided by a 32 bit SCTP sequence numbers (TSN)
  - The initial sequence number is a random 32 bit number
  - These sequence numbers are in the header of individual chunks
  - This cumulative number is used to provide both flow control and error control
- SCTP **resequences** data at the receiving side
- SCTP **discards duplicate** data at the receiving side

The **window size** (or more exactly the receive window size (rwnd)) - indicates how many bytes the receiver is prepared to receive (this number is **relative** to the acknowledgement number).

# Forward Cumulative TSN

Allows an endpoint to signal to its peer that it should move the cumulative acknowledgement forward [7]. This protocol extension adds a new parameter (Forward-TSN-Supported) to INIT and INIT ACK, and a new FORWARD TSN chunk type. It provides an example of a partially reliable service.

|                    |     |                    |       |        |
|--------------------|-----|--------------------|-------|--------|
| 0                  | 7 8 | 15 16              | 23 24 | 31     |
| Type = 192         |     | Flag = 0           |       | Length |
| New cumulative TSN |     |                    |       |        |
| Stream #1          |     | Stream Sequence #1 |       |        |
| ...                |     | ...                |       |        |
| Stream #N          |     | Stream Sequence #N |       |        |

Figure 18: SCTP FORWARD TSN Chunk (see [7])

- Stream<sub>i</sub> a stream number that was skipped by this FWD-TSN.
- Stream Sequence<sub>i</sub> = the largest stream sequence number in stream<sub>i</sub> being skipped

- Receiver can use the Stream<sub>i</sub> and Stream Sequence<sub>i</sub> fields to enable delivery of (stranded) TSN's that remain in the stream re-ordering queues.

# SCTP Performance

See the upcoming exjobb report by Mia Immonen.

# Transport Protocol Functional Overview

From table 1-1 of [4] on page 12; also appears in [13]

| Protocol Feature                             | SCTP | TCP | UDP |
|--|------|-----|-----|
| State required at each endpoint              | Yes  | Yes | No  |
| Reliable data transfer                       | Yes  | Yes | No  |
| Congest control and avoidance                | Yes  | Yes | No  |
| Message boundary conservation                | Yes  | No  | Yes |
| Path MTU discovery and message fragmentation | Yes  | Yes | No  |
| Message bundling                             | Yes  | Yes | No  |
| Multi-homed hosts support                    | Yes  | No  | No  |
| Multi-stream support                         | Yes  | No  | No  |
| Unordered data delivery                      | Yes  | No  | Yes |
| Security cookie against SYN flood attack     | Yes  | No  | No  |
| Built-in heartbeat (readability check)       | Yes  | No  | No  |



# Summary

This lecture we have discussed:

- **SCTP**
  - Message framing
  - Multi-homing
  - Multi-streaming
- How SCTP differs from TCP
- Measurements of an implementation (there are other implementations such as that included with [4]):
  - <http://www.sctp.de>
  - <http://www.sctp.org>
  - Linux Kernel SCTP <http://sourceforge.net/projects/lksctp>

# References

- [1] G. Sidebottom, K. Morneault, and J. Pastor-Balbas, “Signaling System 7 (SS7) Message Transfer Part 3 (MTP3) - User Adaptation Layer (M3UA)”, IETF RFC 3332, September 2002 <http://www.ietf.org/rfc/rfc3332.txt>
- [2] Andreas Jungmaier, “A Gentle Introduction to SCTP”, 19th Chaos Communications Congress, Berlin, 2002  
[http://tdrwww.exp-math.uni-essen.de/inhalt/forschung/19ccc2002/html/slide\\_1.html](http://tdrwww.exp-math.uni-essen.de/inhalt/forschung/19ccc2002/html/slide_1.html)
- [3] R. Stewart, Q. Xie, K. Morneault, C. Sharp, H. Schwarzbauer, T. Taylor, I. Rytina, M. Kalla, L. Zhang, and V. Paxson, “Stream Control Transmission Protocol”, IETF RFC 2960, October 2000 <http://www.ietf.org/rfc/rfc2960.txt>
- [4] Randall R. Stewart and Qiaobing Xie, “Stream Control Transmission Protocol: A Reference Guide”, Addison-Wesley, 2002, ISBN 0-201-72186-4.
- [5] K. Morneault, S. Rengasami, M. Kalla, and G. Sidebottom, “ISDN Q.921-User Adaptation Layer”, IETF RFC 3057, February 2001  
<http://www.ietf.org/rfc/rfc3057.txt>
- [6] Andreas Jungmaier, Herbert Hölzlwimmer, Michael Tüxen, and Thomas Dreiholz, "sctplib-1.0.2", Siemens AG and the Institute of Computer Networking Technology, University of Essen, Germany, August 2004 <http://www.sctp.de/sctp-download.html>  
{Note that a later version 1.0.3 was released March 4th, 2005}
- [7] R. Stewart, M. Ramalho, Q. Xie, M. Tuexen, and P. Conrad, “Stream Control Transmission Protocol (SCTP) Partial Reliability Extension”, IETF RFC 3758, May 2004 <http://www.ietf.org/rfc/rfc3758.txt>
- [8] J. Mogul and S. Deering, “Path MTU Discovery”, IETF RFC 1191, November 1990  
<http://www.ietf.org/rfc/rfc1191.txt>
- [9] J. McCann, S. Deering, and J. Mogul, “Path MTU Discovery for IP version 6”, IETF RFC 1981, August 1996  
<http://www.ietf.org/rfc/rfc1981.txt>
- [10] S. Deering and R. Hinden, “Internet Protocol, Version 6 (IPv6) Specification”, IETF RFC 2460, December 1998  
<http://www.ietf.org/rfc/rfc2460.txt>
- [11] J. Stone, R. Stewart, and D. Otis, “Stream Control Transmission Protocol (SCTP) Checksum Change”, IETF RFC 3309, September

2002 <http://www.ietf.org/rfc/rfc3309.txt>

- [12] A. Jungmaier, E. Rescorla, and M. Tuexen, “Transport Layer Security over Stream Control Transmission Protocol”, IETF RFC 3436, December 2002 <http://www.ietf.org/rfc/rfc3436.txt>
- [13] “SCTP Primer”, Mon, Mar 1, 2004 03:35:54 PM <http://datatag.web.cern.ch/datatag/WP3/sctp/primer.htm>
- [14] Mia Immonen, “SIGTRAN: Signaling over IP a step closer to an all-IP network”, Masters thesis, Royal Institute of Technology (KTH), Dept. of Communication Systems, June 2005  
<ftp://ftp.it.kth.se/Reports/DEGREE-PROJECT-REPORTS/050619-Mia-Immonen-with-cover.pdf>

# IK1550 Internetworking/Internetteknik

## Spring 2010, Period 4

### Module 7: Dynamic Routing

Lecture notes of G. Q. Maguire Jr.



**KTH Information and  
Communication Technology**

© 2010 G.Q.Maguire Jr. .

All rights reserved. No part of this course may be reproduced, stored in a retrieval system, or transmitted, in any form or by any means, electronic, mechanical, photocopying, recording, or otherwise, without written permission of the author.

Last modified: 2010.03.21:17:37

# Outline

- Dynamic Routing Protocols

# Routing

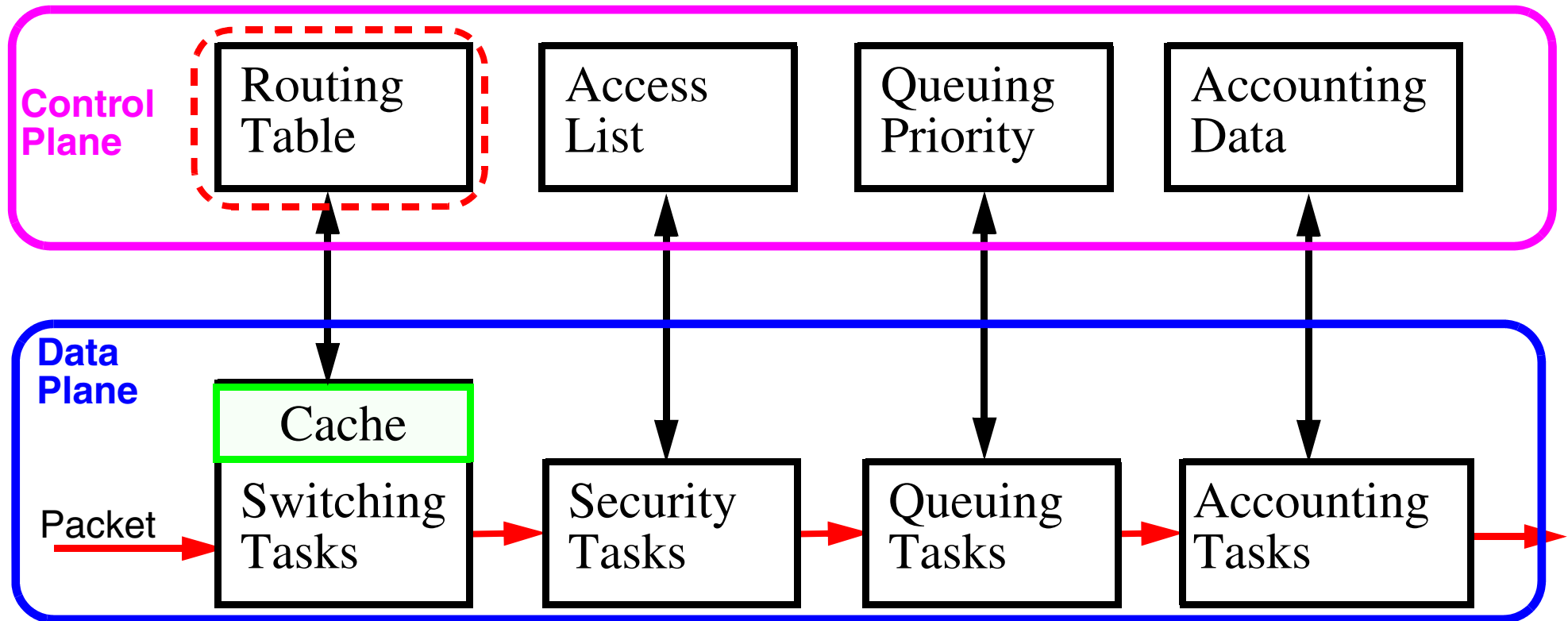

Figure 1: Basic steps in Routing

The routing table tells us which output port to use based on the destination (and possibly the source) IP address. The **data plane** has to run at packet rates (i.e., in real-time). However, a router also performs a lot of other processing

# Routing Principles

- Routing **Mechanism**: Use the *most specific* route
  - IP provides the mechanism to route **packets**
- Routing **Policy**: What routes should be put in the routing **table**? <<<  
**today's topic!**
  - Use a routing daemon to provide the *routing policy*

For further information see:

Bassam Halabi, *Internet Routing Architectures*, Cisco Press, 1997, ISBN 1-56205-652-2. -- especially useful for IGRP.

# Basic Router Software Architecture

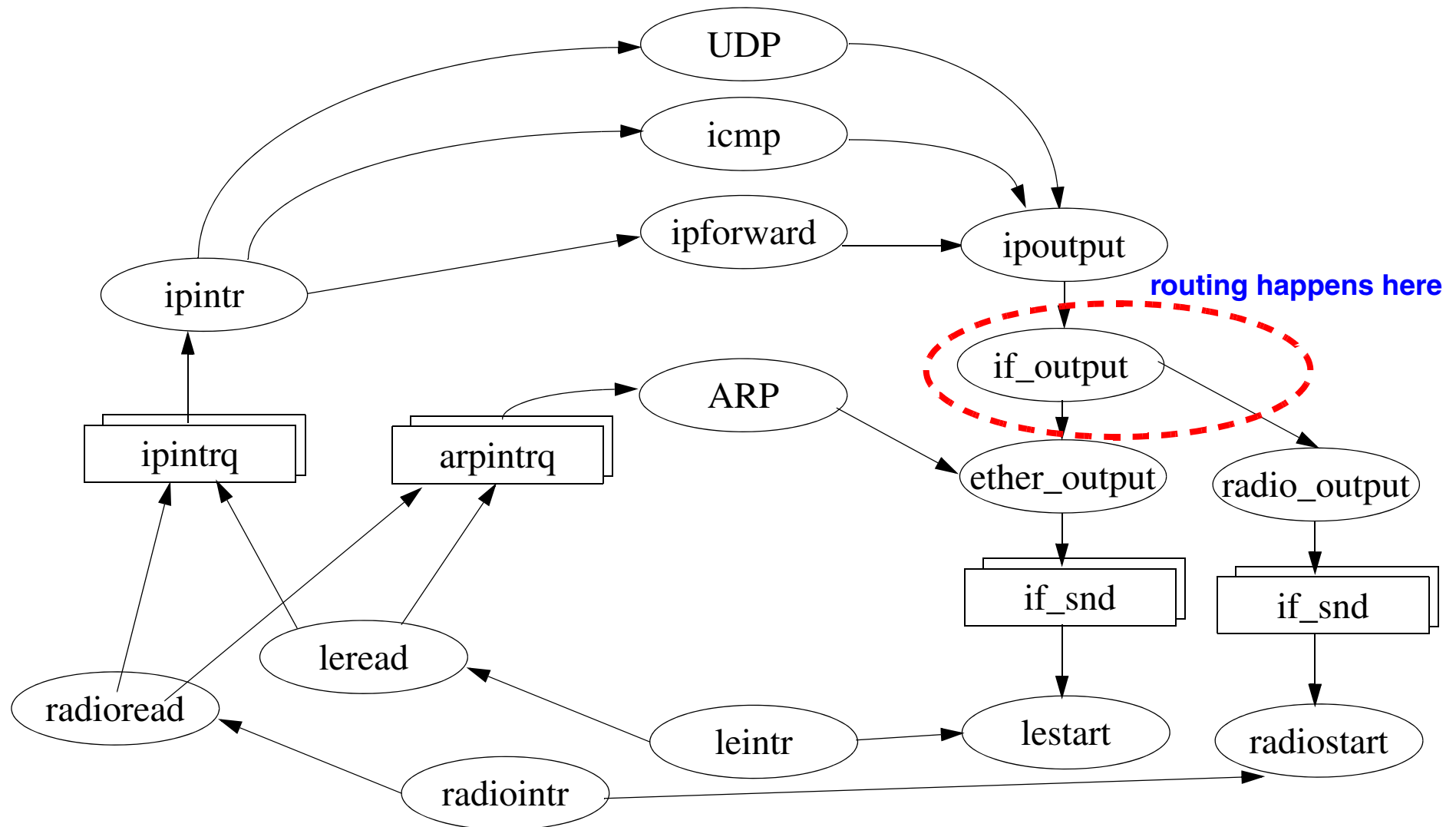
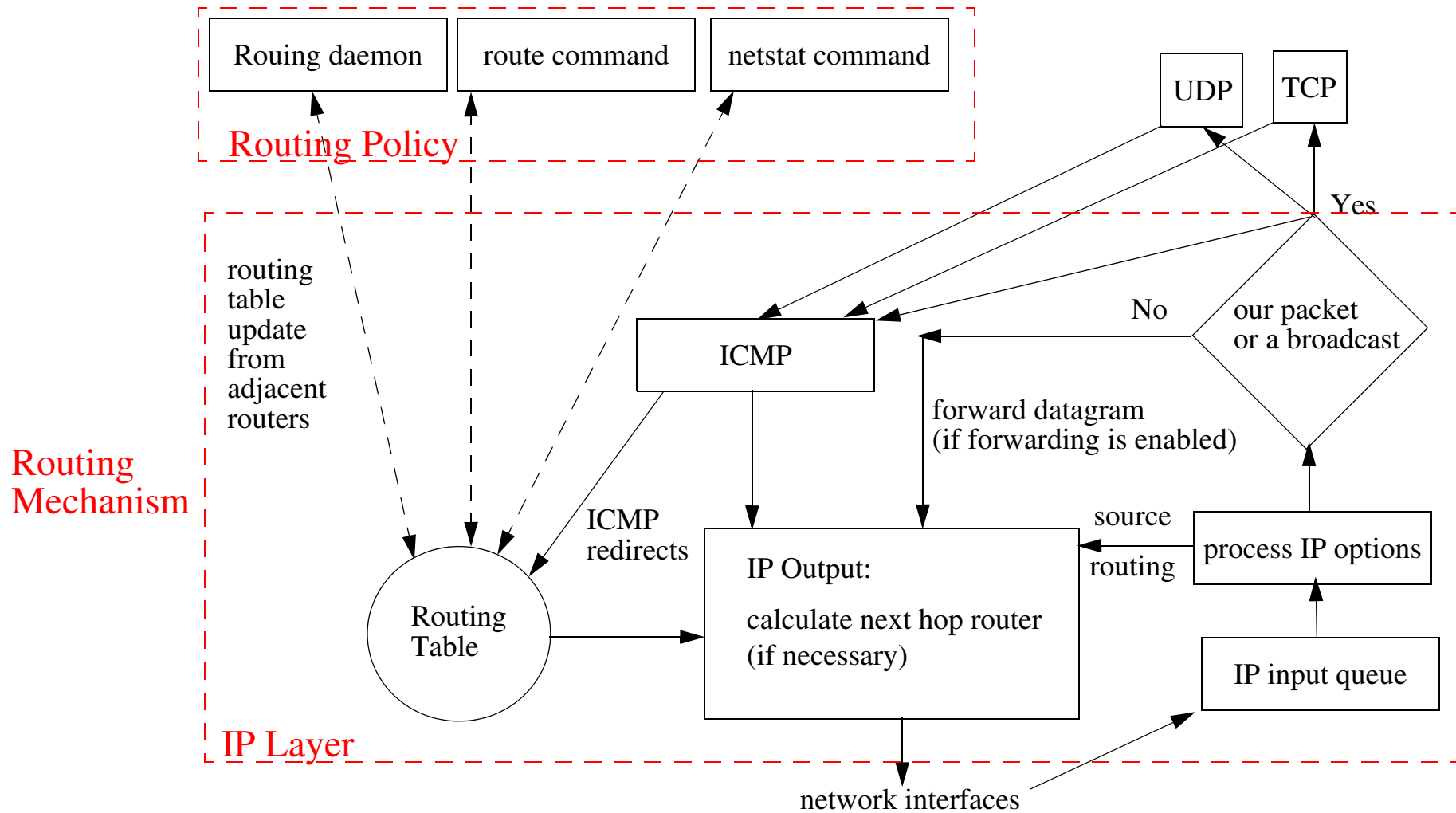

Figure 2: Basic Router Architecture (assuming a radio and an ethernet interface)



# Processing



# Routing packets in the Internet

Router needs to know where to route packets, to do this they need routing information. Such information can be provided by **manually entered routes** or ICMP Redirect or learning of routes via **a routing protocol**.

**Dynamic routing protocols** are based on routers talking to each other.

- **Intradomain** - within an AS (aka **Interior Gateway protocols**)
- **Interdomain** - between ASs (aka **Exterior Gateway protocols**)

The most popular dynamic routing protocols are:

- **RIP-1** - Routing Information Protocol (version 1)
- **RIP-2** - Routing Information Protocol (version 2)
- **OSPF** - Open Shortest Path First
- **BGP** - Border Gateway Protocol

# Autonomous systems (ASs) - RFC1930 [1]

Each of which is generally administered by a **single entity**.

Each autonomous system selects the routing protocol to be used **within** the AS.

| Network                            | AS number         |
|------------------------------------|-------------------|
| Swedish University Network (SUNET) | AS1653 and AS2859 |
| SUNET-KI                           | AS2837            |
| Stockholm University - SU          | AS2838            |
| SUNET-KTH                          | AS2839            |
| KTHNOC KTHNOC-SE                   | AS3224            |

For statistics about the number of AS, etc.: <http://www.cidr-report.org/>

For a list of AS number to name mappings: <http://www.cidr-report.org/autnums.html>

To find out who is responsible for a given autonomous system, use a query of the form: <http://www.ripe.net/perl/whois?AS2839>

# Routing Metrics

A measure of which route is better than another:

- Number of hops
- Bandwidth
- Delay
- Cost
- Load
- ...

It is possible that the metric uses some **weighted combination** of the above.

# Routing Algorithms

- Static vs. Dynamic
- Single path vs. Multi-path
- Flat vs. Hierarchical
- Host-intelligent vs. Router-intelligent
- Intradomain (interior) vs. Interdomain (exterior)
- Link state vs. Distance vector

## Issues:

- Initialization (how to get started)
- Sharing
- Updating
- When to share & Who to share with

# Intradomain routing protocols

also called “Interior Gateway protocols”

Examples:

- HELLO - an old IGP protocol
- RIP - widely used
- OSPF - increasingly used

Routers that speak **any** dynamic routing protocol **must** speak RIP and OSPF.

# Routing Information Protocol (RIP) version 1

RFC 1058 [2] {Note it was written years after the protocol was in wide use!}

RIP is a **distance-vector** protocol - RIP messages contain a vector of **hop counts**.  
RIP messages are carried via UDP datagrams which are **broadcast**.

|                 |   |             |        |    |          |    |    |
|-----------------|---|-------------|--------|----|----------|----|----|
| 0               | 7 | 8           | 15     | 16 | 23       | 24 | 31 |
| Command         |   | Version = 1 |        |    | Reserved |    |    |
| Family          |   |             | All 0s |    |          |    |    |
| Network Address |   |             |        |    |          |    |    |
| All 0s          |   |             |        |    |          |    |    |
| All 0s          |   |             |        |    |          |    |    |
| Distance        |   |             |        |    |          |    |    |

Figure 3: RIP message format (see Forouzan figure 14.9 pg. 394)

- a command: **request** or **reply**
- a version number (in this case 1)
- up to 25 instances (entries) containing:
  - address family (2 = IP addresses)
  - Network Address (allocated 14 bytes, for an IP address we only need 4 bytes - and they are aligned to a 4 byte boundary - hence the leading and trailing zeros)
  - metric [hop count]

# RIP v1 operation

As carried out by UNIX daemon “routed” using UDP port 520

## Initialization:

```
for all interface which are up
{
    send a request packet out each interface asking for the other
    router's complete routing table
        [command=1, address family=0 {== unspecified}1, metric=16
    }
}
```

## Request received:

```
if whole table requested, then send it all 25 at a time
else if a specific set of routes
    then fill in the metric
    else set metric to 16
        [16 == "infinity" == we don't know a route to this address]
```

## Response received:

```
if valid (i.e., not 16), then update/add/delete/modify routing table
```

---

1. Page 24 of RFC 1058 says “If there is exactly one entry in the request, with an address family identifier of 0 (meaning unspecified), and a metric of infinity (i.e., 16 for current implementations), this is a request to send the entire routing table.”[2] - this is different than implied in Forouzan figure 14.10 pg. 395



## When are routes sent?

**Solicited response:** Send a response when a request is received

**Unsolicited response:**

- If a metric for a route changes, then (trigger) send update, else send all or part of the table every 30 seconds.
- If a route has not been updated for 180 seconds (3 minutes = 6 update cycles), then set metric to 16 and then **after** 60 seconds (1 minute) delete route.

Metrics are in units of hops, thus this protocol leads to selection between routes based on the minimum number of hops.

Summary of RIPv1 Timers:

- **Periodic** timer - regular updates random value [25..35] mean 30 s.
- **Expiration** timer - routes not updated within (180 s) expire
- **Garbage collection** timer - 120 s after expiring entries are GC'd

# Problems with RIP v1

- RIPv1 does **not** know about subnets (or assumes all interfaces on the network have the same netmask)
- after a router or link failure RIP takes **minutes** to stabilize (since each neighbor only speaks ~every 30 seconds; so the time for the information to propagate several hops is minutes)  $\Rightarrow$  while it is unstable it is possible to have routing loops, etc.
- Hops count may **not** be the best indication for which is the best route
- Since the maximum useful metric value is 15, the network diameter must be less than or equal to 15.
- RIP will accept updates from **anyone** - so one misconfigured device can disrupt the entire network.
- RIP uses more bandwidth than other protocols, since it sends the whole routing table in updates.

# Count to Infinity

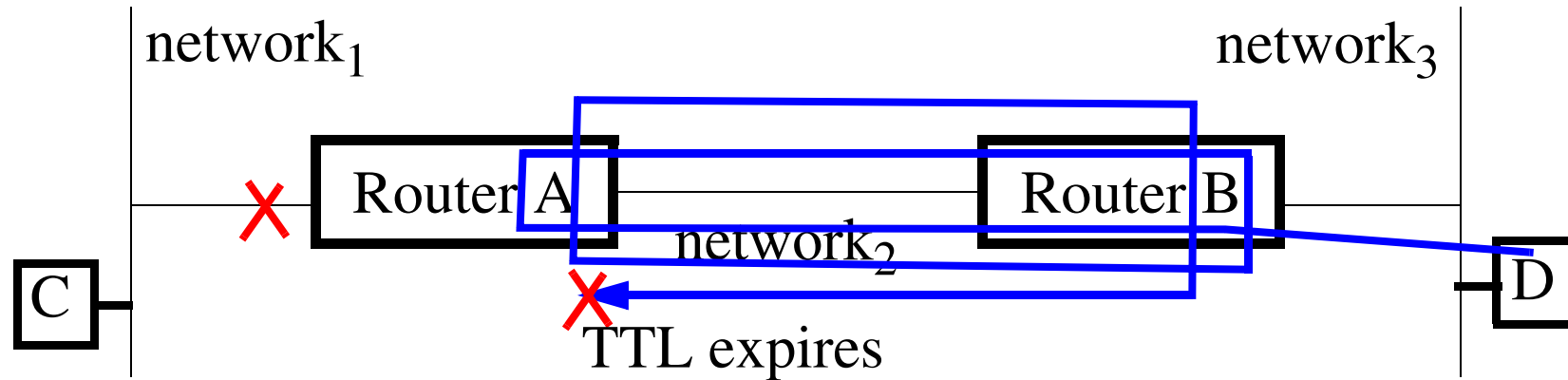

- Router A advertises it knows about routes to networks 1 and 2
- Router B advertises it knows about routes to networks 2 and 3
- After one update cycles A and B know about all 3 routes.

If A's interface to Network<sub>1</sub> goes down, then A learns from B - that B knows a route to Network<sub>1</sub>; so A now thinks it can reach Network<sub>1</sub> via B. So if D sends a packet for C, it will simply loop back and forth between routers A and B, until the TTL counts down to 0.

# Split Horizon

To counter the count to infinity, the split horizon algorithm - never sends information on an interface that it learned from this interface.

RIPv1 implements: Split Horizon with **Poison Reverse Update** - rather than not advertise routes to the source, we advertise them with a metric of 16 (i.e., unreachable) - hence the source simply ignores them.

Unfortunately split horizon only prevents loops between **adjacent** routers (so if there are three or more routers involved the previous problem re-appears)

# Triggered updates and Hold-Downs

To decrease convergence time - when the topology changes send out an update immediately.

However, if a node can learn about connectivity from more than one source, then if a delete happens before the add, then the existence of the route is asserted; therefore the hold-down rules says:

When a route is removed, no update of this route is accepted for some period of time - to give everyone a chance to remove the route.

This period of time is the Hold-down time.

The result is to **decrease** the rate of convergence; but the combined effect of **triggered updates + hold-downs leads to faster** convergence than not using triggered updates.

# RIP extensions (aka RIP-2)

Defined in RFC 1388 [3] and revised in RFC 2453[4]. Version number is 2.

- for each of up to 25 entries we add the fields:
  - **Route tag** - carries the AS number
  - **Subnetmask** - subnetmask to be used with this address (to support **classless addressing**)
  - **Next-hop IP address**, either the IP address of where packets to this destination should be sent or zero [which means send them to the system which sent the RIP message]
- One entry can be replaced by **Authentication** data

RIP-2 supports multicast to address 224.0.0.9, to reduce load on hosts **not** interested in RIP-2 messages

|   |     |                     |       |          |
|---|-----|---------------------|-------|----------|
| 0   | 7 8 | 15 16               | 23 24 | 31       |
| Command   |     | Version = 2         |       | Reserved |
| 0xFFFF  |     | Authentication type |       |          |
| Authentication data (16 bytes)<br>if Authentication type = 2, this is a clear text password to be used to authenticate this message |     |                     |       |          |
| Family  |     | Route tag           |       |          |
| Network Address   |     |                     |       |          |
| Subnet mask   |     |                     |       |          |
| Next-hop address  |     |                     |       |          |
| Distance  |     |                     |       |          |

Figure 4: RIPv2 message format (see Forouzan figures 14.13 pg. 397 and 14.14 pg. 398)

# Why would anyone use RIP?

After all these problems you might ask this question.

## Answer

- Because RIP is generally the only routing protocol which **all** UNIX machines understand!
- Relatively easy to configure
- It is widely available, since it **must** exist if the device is capable of routing!

# Interior Gateway Routing Protocol (IGRP)

Cisco's IGRP [5] - a proprietary protocol with the following goals:

- stable, optimal routing for large networks - with no routing loops
- fast response to changes in net topology
- low overhead in both bandwidth and processor utilization
- ability to **split traffic across several parallel routes** if they are (or nearly are) equal.

It is a distance-vector protocol based on many of the ideas from RIP.



# IGRP Metrics

- a vector of metrics each with a 24 bit value
- composite metric is  $\left[ \left( \frac{K_1}{B} \right) + \left( \frac{K_2}{D} \right) \right] \cdot R$ , where  $K_1$  and  $K_2$  are constants,  $B$  the unloaded path bandwidth,  $D$  a topological delay, and  $R$  is reliability
- also we pass the **hop count** and **Maximum Transmission Unit** values

$K_1$  is the weight assigned to bandwidth (by default 10,000,000)

$K_2$  is the weight assigned to delay (by default 100,000)

If up to 4 paths are within a defined **variance** of each other, Cisco's IOS (Internetwork Operating System) will split the traffic across them in inverse proportion to their metric.

# IGRP Route Poisoning

IGRP poisons routes which increase by a factor of 10% or more after an update [they are thought to be: “too good to be true”].

While this rule may temporarily delete valid routes (which will get reinstated after the next regular update) - it allows use of a zero hold-down time, which leads to faster convergence.

# IGRP Default Gateway

Rather than using the fake network 0.0.0.0 to indicate the default network, IGRP allows a real network to be flagged as the default network.

Periodically, IGRP scans the routes offering a path to this flagged network and selects the path with the lowest metric.

Note: Default gateways help to keep the size of local routing tables smaller.

# Enhanced IGRP (EGRP) [6]

Uses the distance-vector technology of IGRP, but changes the way routes are advertised and the calculation of entries for the routing table.

EGRP uses:

- a neighbor discover/recovery process of hello packets to learn its neighbors
- a Reliable Transport Protocol to ensure guaranteed, ordered delivery of routing updates
- a Diffusing Update Algorithm (DUAL) - which selects both the best route for insertion into the table **and** a **feasible successor** (for if the primary route fails)
- Variable length subnet masks (VLSM)

EGRP is a Cisco proprietary technology.

# Open Shortest Path First (OSPF)

OSPF defined in RFC2328 (see also <http://rtg.ietf.org/wg/ospf/> )

OSPF is a **link-state** protocol. OSPF messages (Link State Advertisements (LSAs)) tell the **status of links** of each of its neighbors and propagates this info to its neighbors. Each router uses this link-state information to build a **complete** routing table. Uses IP directly (protocol field = OSPF (89))  $\Rightarrow$  does **not** use UDP or TCP.

## Advantages

- link-state protocols converge faster than distance-vector protocols
- can calculate a route per IP service type (i.e., TOS)
- each interface can have a per TOS cost
- if there are several equally good routes  $\Rightarrow$  can do **load balancing**
- supports variable length subnet masks
- enable point to point links to be **unnumbered** (i.e., don't need an IP address)
- uses clear text passwords
- uses multicasting

OSPF uses the Shortest Path First algorithm (also known as [Dijkstra's algorithm](#)).

OSPF networks are generally divided into [areas](#) such that cross-area communication is minimal.

Some routers with multiple interfaces become [border area routers](#) (with one interface in one area and another interface in another area).

The only way to get from one area to another area is via the [backbone](#) - which is area 0. Note: The backbone need **not** be continuous.

- Note that Forouzan refers to “transient” links -- I think that this should be “transit” links. (Since transient implies that the link would be short lived!)

Link state advertisements are sent to all routers in a given area (via [flooding](#)), rather than just neighbors (as in the distance-vector approach) - thus periodic updates are infrequent (every 1 to 2 hours).

A key feature of OSPF is [route aggregation](#) - which minimizes the size of routing tables and the size of the topological database; in addition, it keeps protocol traffic to a minimum.

# OSPF building blocks

## 1. Hello protocol

- Check for & with neighbors and learn designated routers

## 2. Synchronization of Databases

- Exchange of Link State Database between neighbors
  - Get LSA **headers**
  - Request the transfer of necessary LSAs

## 3. Flooding protocol

- When links change or when your knowledge is old
  - Send Link State updates to neighbors and flood recursively
  - If not seen before, propagate updates to all adjacent routers, except the router you received it from

# OSPF Packets

## Common header

|                                       |   |      |    |                     |    |    |    |
|---------------------------------------|---|------|----|---------------------|----|----|----|
| 0                                     | 7 | 8    | 15 | 16                  | 23 | 24 | 31 |
| Version                               |   | Type |    | Message length      |    |    |    |
| Source Router IP Address              |   |      |    |                     |    |    |    |
| Area Identification                   |   |      |    |                     |    |    |    |
| Checksum                              |   |      |    | Authentication type |    |    |    |
| Authentication (64 bits) <sup>a</sup> |   |      |    |                     |    |    |    |

Figure 5: OSPF Common Header (see Forouzan figure 14.26 pg. 408)

a. Note that the Authentication field is 64 bits, Forouzan figure 14.26 pg. 408 incorrectly shows it as 32 bits.

## The 5 types of OSPF packets:

| Type | Description               |
|------|---------------------------|
| 1    | Hello                     |
| 2    | Database Description      |
| 3    | Link State Request        |
| 4    | Link State Update         |
| 5    | Link State Acknowledgment |



# Hello packet

|                                     |   |          |    |                     |                |    |    |          |
|-------------------------------------|---|----------|----|---------------------|----------------|----|----|----------|
| 0                                   | 7 | 8        | 15 | 16                  | 23             | 24 | 31 |          |
| Version                             |   | Type = 1 |    |                     | Message length |    |    |          |
| Source Router IP Address            |   |          |    |                     |                |    |    |          |
| Area Identification                 |   |          |    |                     |                |    |    |          |
| Checksum                            |   |          |    | Authentication type |                |    |    |          |
| Authentication (64 bits)            |   |          |    |                     |                |    |    |          |
| Network Mask                        |   |          |    |                     |                |    |    |          |
| Hello interval (seconds)            |   |          |    | All zeros           |                | E  | T  | Priority |
| Dead interval (seconds)             |   |          |    |                     |                |    |    |          |
| Designated router IP address        |   |          |    |                     |                |    |    |          |
| Backup designated router IP address |   |          |    |                     |                |    |    |          |
| Neighbor IP address                 |   |          |    |                     |                |    |    |          |
| ...                                 |   |          |    |                     |                |    |    |          |
| Neighbor IP address                 |   |          |    |                     |                |    |    |          |

Figure 6: OSPF Link state update packet (see Forouzan figure 14.44 pg. 419)

- E = 1 indicates a stub area
- T = 1 indicates router supports multiple metrics
- priority = 0 indicates that this router should not be considered as a designated or backup designated router
- Dead interval is the time before a silent neighbor is assumed to be dead
- list of neighboring routers (of the router which sent the hello packet)

# Database Description packet

|                                      |   |          |    |                     |                |    |           |
|--------------------------------------|---|----------|----|---------------------|----------------|----|-----------|
| 0                                    | 7 | 8        | 15 | 16                  | 23             | 24 | 31        |
| Version                              |   | Type = 2 |    |                     | Message length |    |           |
| Source Router IP Address             |   |          |    |                     |                |    |           |
| Area Identification                  |   |          |    |                     |                |    |           |
| Checksum                             |   |          |    | Authentication type |                |    |           |
| Authentication (64 bits)             |   |          |    |                     |                |    |           |
| Interface MTU                        |   |          |    | All zeros           | E              | B  | All zeros |
|                                      |   |          |    |                     |                | I  | M         |
|                                      |   |          |    |                     |                | M  | S         |
| Database Description sequence number |   |          |    |                     |                |    |           |
| LSA header (20 bytes)                |   |          |    |                     |                |    |           |
| ...                                  |   |          |    |                     |                |    |           |
| LSA header                           |   |          |    |                     |                |    |           |

Figure 7: OSPF Database Description packet (see Forouzan figure 14.45 pg. 420)

- Rather than send the entire database - send an outline of it
  - E = 1 indicates the advertising router is an autonomous boundary router (i.e., E ≡ external)
  - B = 1 indicates the advertising router is an autonomous border router
  - I = 1 initialization flag
  - M = 1 ≡ More flag
  - M/S flag: 0=slave, 1=Master
  - Database Description sequence number
  - LSA header(s) - gives information about the link - but **without** details; if details are desired they can be requested

# Link State Announcement (LSA) header

Each different LSA has the same general header:

|                            |     |          |        |    |                 |
|----------------------------|-----|----------|--------|----|-----------------|
| 0                          | 7 8 | 15 16    | 23 24  | 31 |                 |
| Link state age (seconds)   |     | Reserved | E      | T  | Link State type |
| Link state ID              |     |          |        |    |                 |
| Advertising router         |     |          |        |    |                 |
| Link state sequence number |     |          |        |    |                 |
| Link state checksum        |     |          | Length |    |                 |

Figure 8: OSPF Link State Advertisement general header format (see Forouzan figure 14.28 pg. 410)

- E = 1 indicates a stub area
- T = 1 indicates router supports multiple metrics

| Link state type | Link state ID                       | Description                      |
|-----------------|-------------------------------------|----------------------------------|
| 1               | IP address of the router            | Router-LSAs                      |
| 2               | IP address of the designated router | Network-LSAs                     |
| 3               | IP address of the network           | Summary-LSAs (IP network)        |
| 4               | IP address of the border router     | Summary to AS border router (BR) |
| 5               | IP address of the external network  | AS-external-LSAs                 |

- Advertising router - IP address of the router advertising this message
- Link state checksum - a Fletcher's checksum of all but age field

- Length of the whole packet in bytes

# Link state update packet

|                                     |   |          |    |                     |                |    |    |
|-------------------------------------|---|----------|----|---------------------|----------------|----|----|
| 0                                   | 7 | 8        | 15 | 16                  | 23             | 24 | 31 |
| Version                             |   | Type = 4 |    |                     | Message length |    |    |
| Source Router IP Address            |   |          |    |                     |                |    |    |
| Area Identification                 |   |          |    |                     |                |    |    |
| Checksum                            |   |          |    | Authentication type |                |    |    |
| Authentication (64 bits)            |   |          |    |                     |                |    |    |
| Number of link state advertisements |   |          |    |                     |                |    |    |
| Link state advertisement (LSA)      |   |          |    |                     |                |    |    |
| ...                                 |   |          |    |                     |                |    |    |
| Link state advertisement (LSA)      |   |          |    |                     |                |    |    |

Figure 9: OSPF Link state update packet (see Forouzan figure 14.27 pg. 409)

# Link state request packet

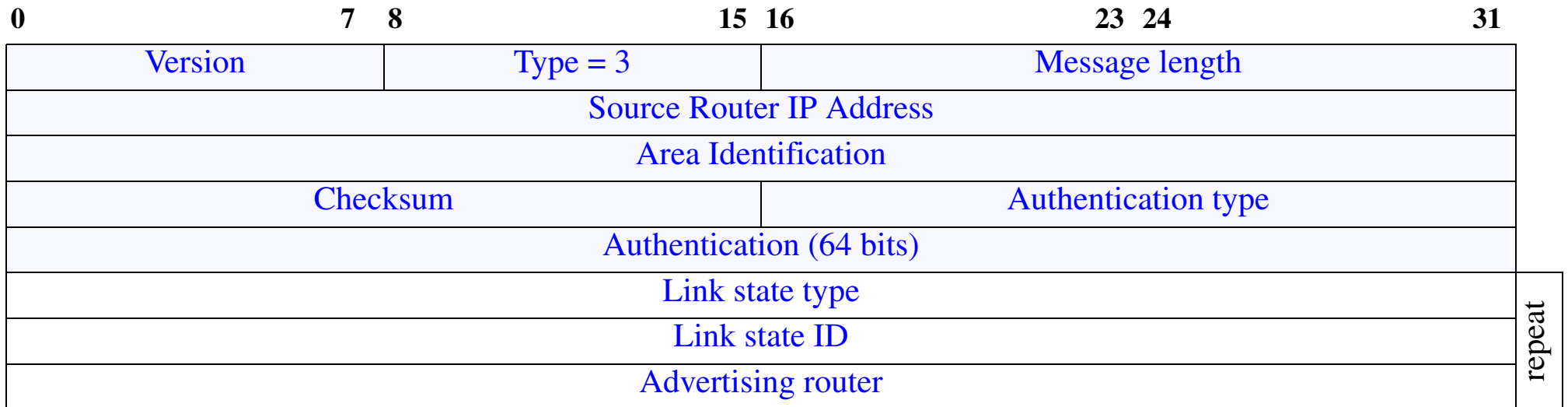

Figure 10: OSPF Link state request packet (see Forouzan figure 14.46 pg. 420)

To ask for information about a specific route (or routes); reply is an update packet.

# Link state acknowledgement packet

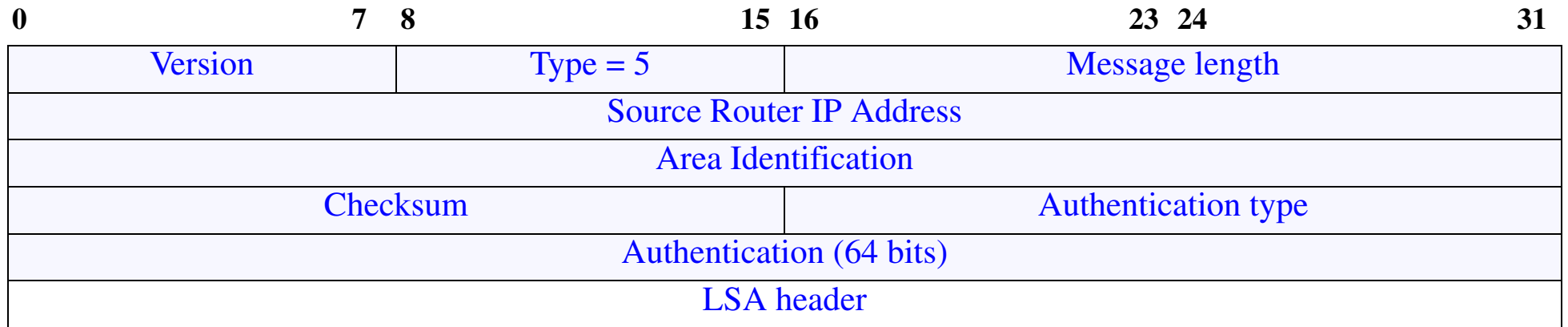

Figure 11: OSPF Link state acknowledgement packet (see Forouzan figure 14.47 pg. 421)

To acknowledge receipt of an update packet.

# Interdomain routing protocols

also called “Exterior Gateway Protocols (EGPs)” - used **between** ASs

Examples:

- EGP - an old EGP protocol
- BGP - Border Gateway Protocol

Intradomain routing protocols:

- don't scale up to the large numbers of routers involved in interdomain routing (due to the huge computational resources required)
- distance vector routing becomes unstable beyond a few hops



# Exterior Gateway Protocol (EGP)

an exterior gateway protocol with three components:

- neighbor acquisition
- neighbor reach ability, and
- routing information

EGP was designed to provide more automation in configuring routers.

EGP is similar to the distance-vector protocols, but **omits the metrics**, since EGP was designed for the internet where typically routers are connected to a backbone (with its own routing domain) via a single router.

- But since there are no metrics, if there is more than one path, then there can be a loop!

# BGP - Border Gateway Protocol

An exterior gateway protocol to exchange routing information between routers in different ASs.

BGP version 3 defined in RFC 1267[9], while version 4 defined in RFC1654[10] and RFC 1771[11].

BGP routers exchange routing information with other BGP routers.

For further information see:

John W. Stewart III, *BGP4: Inter-Domain Routing in the Internet*, Addison-Wesley, 1999, ISBN: 0-201-37951-1 [12]

See also [20] and [21].

# Local vs. Transit traffic

Local traffic: originates or terminates in an AS

Transit traffic: is all other traffic

==> 3 types of ASs

|               |   |
|---------------|---|
| stub AS       | connected to only on other AS, carries only local traffic         |
| multihomed AS | connected to multiple AS, but refuses transit traffic             |
| transit AS    | connected to multiple ASs, carries both local and transit traffic |

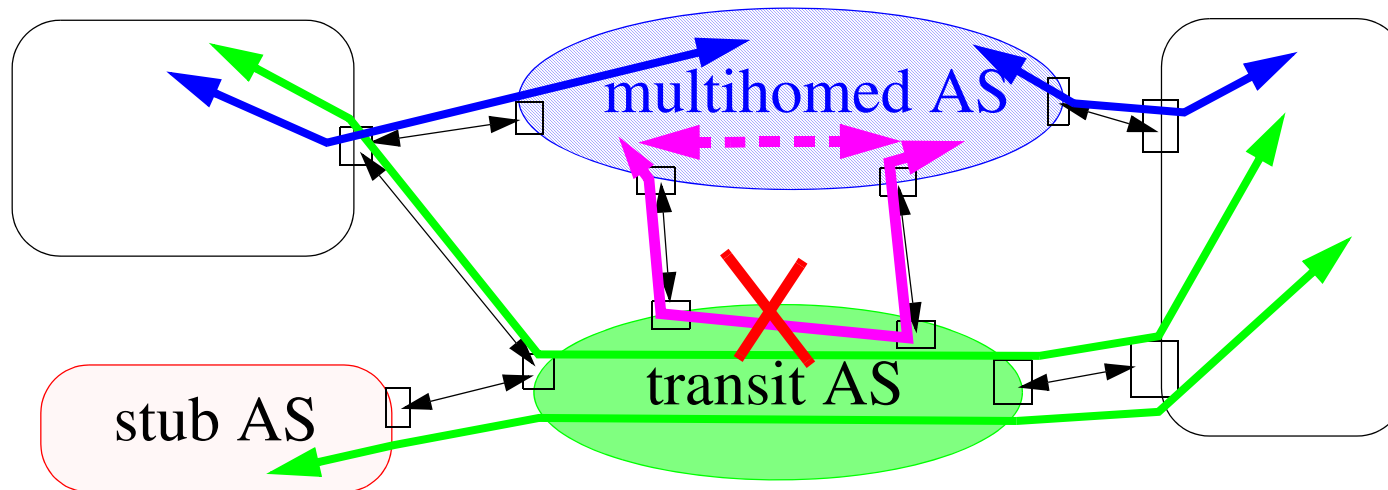

# BGP operation

BGP routers exchange information based on traffic which transits the AS, derives a graph of AS connectivity; with loop pruning.

Routing policy decisions can be enforced as to what is allowed to transit whom

⇒ **policy-based routing**

- based on economic/security/political/... considerations.
- BGP does **not** implement the policy decisions, but allows the information on which such decisions can be made to propagate as necessary

Uses **TCP** (port 179) to create a session between BGP routers:

- initially two systems exchange their entire BGP routing table,
- then they simply send updates as necessary.

BGP is a **path-vector protocol** - which **enumerates** the route to each destination (i.e., the sequence of AS numbers which a packet would have to pass through from a source to its destination) = a **path vector**

BGP does **not** transmit metrics.

However, each path is a list of attributes:

- **well-known attributes** (which every router must understand)
  - well-known **mandatory** attribute - must appear in the description of a route
  - well-known **discretionary** attribute - may appear, but must be recognized, in the description of a route
- **optional attributes**
  - optional **transitive** attribute - must be passed to the next router
  - optional **nontransitive** attribute - the receiving router must discard it if it does not recognize it

For examples of the use of an attribute see [18] and [19]

BGP detects failures (either links or hosts) by sending **keepalive** messages to its neighbors. Generally sent every 30 seconds and as they are only 19 bytes each  $\Rightarrow$  only **~5 bits/second** of bandwidth, but with very long lived TCP connections (**semi-permanent connections**)

A major feature of BGP version 4 is its ability to do **aggregation** - to handle CIDR and supernetting. For more information on aggregation see chapter 5 of [13].

# Classless Inter-Domain Routing (CIDR)

A standard for both classless addressing and classless interdomain routing scheme (RFCs 1517 [14] .. 1520 [17]).

- Basic concept: to allocate/collapse a block of contiguous IP addresses into a single routing table entry: (network address, count). e.g., 192.5.48.0, 192.5.49.0, 192.5.50.0 = (192.5.48.0, 3)
- **Hierarchical Routing Aggregation** minimizes routing table entries; enables "route aggregation" in which a single high-level route entry can represent many lower-level routes in the global routing tables.
  - Reduces the growth of routing table.
- Allows the addresses assigned to a single organization to span multiple classed prefixes.
- Envisioned a hierarchical Internet.

CIDR addressing scheme and route aggregation has two major user impacts:

- you have to **justifying** IP Address Assignments
- get address from your ISP, i.e., **renting** them vs. being **assigned** them

# Redistribution of Route Information between protocols

**Redistribution:** allows a router running more than one routing protocol to distribute information from one protocol to another.

Thus at the border, a router will translate the information obtained from one routing domain and pass it to the other routing domain in the appropriate manner.

- Advertise (aggregated) interior routes to the Internet
- Inject (some) exterior routes into the interior network

Usually the redistributed routes are filtered (as not all the information needs to cross the border).

# Resulting BGP Architecture

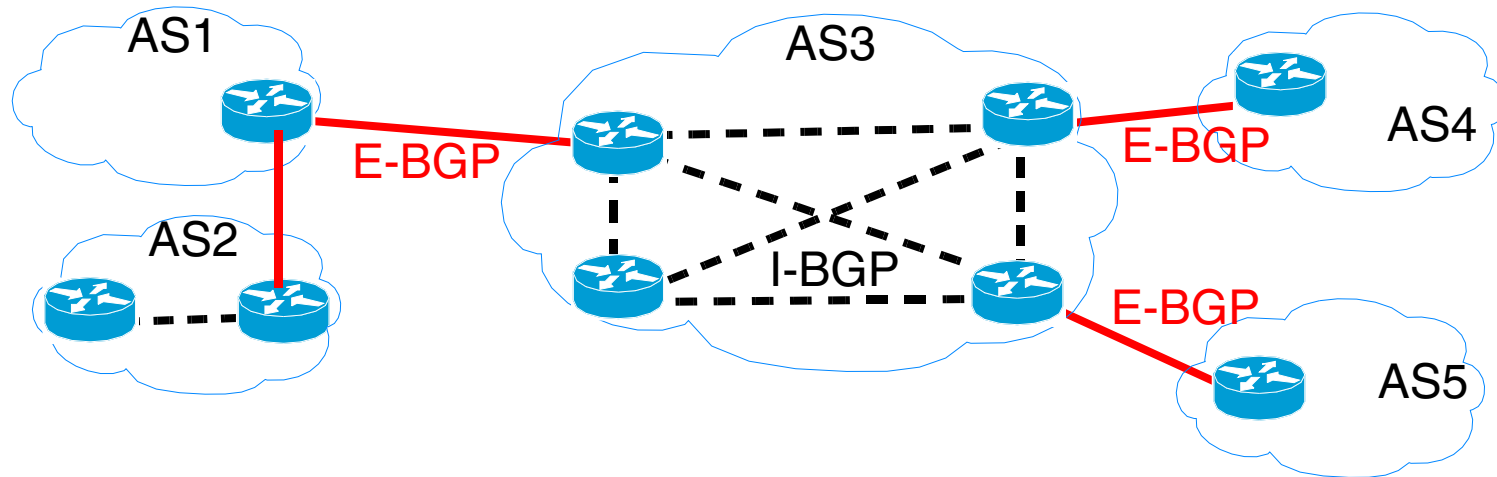

Figure 12: BGP architecture

Two kinds of BGP sessions:

- External (**E-BGP**) coordinates between border routers **between** ASs
- Internal BGP (**I-BGP**) coordinates between BGP peers **within** an AS
  - Note it must be a full mesh, but this does not scale  $\Rightarrow$  organization into subASs, ... .



# BGP Messages

- Open
- Update
- Keepalive
- Notification

# BGP Open Message

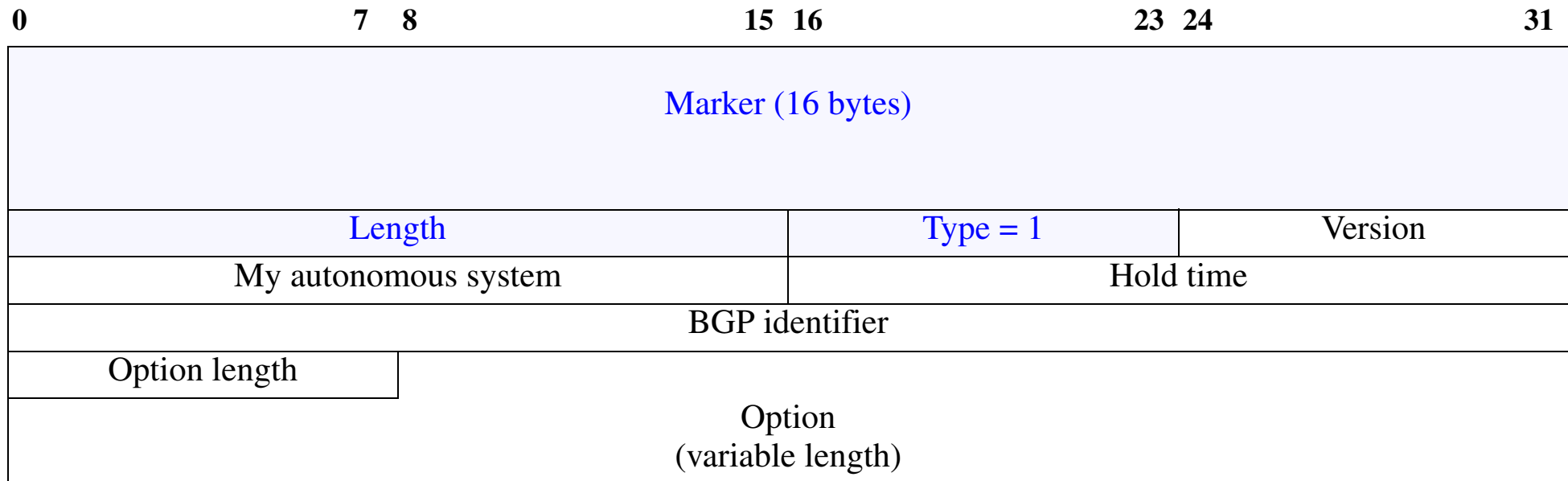

Figure 13: BGP Open messages (see Forouzan figures 14.53 pg. 427 and 14.52 pg. 426)

**Maker** (for authentication), **Length**, and **Type** are common to all BGP messages.

- Version = 4
- My autonomous system - the AS number
- Hold time - maximum time to wait for a keepalive or update, otherwise the other party is considered to be dead
- BGP identifier - identifies the router sending this message (typically its IP address)
- Option length - zero if none
- Option - options in the form (length of parameter, parameter value)

# BGP Update Message

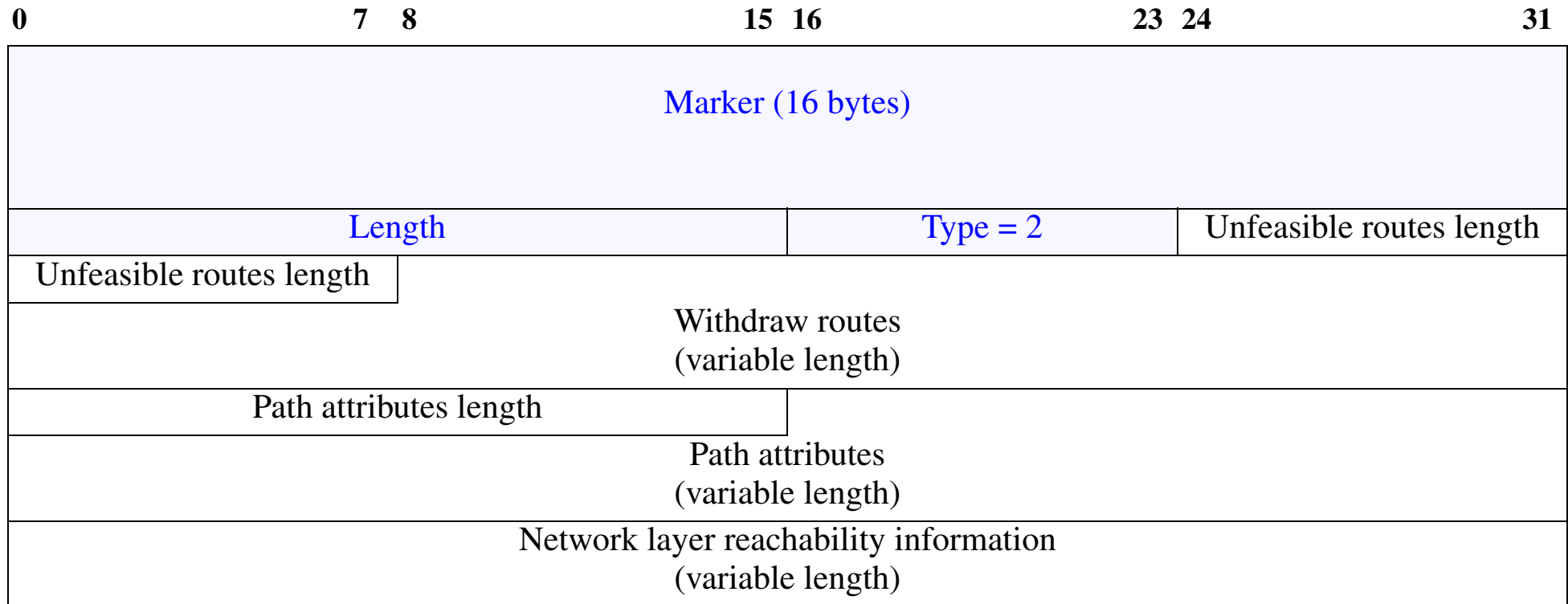

Figure 14: BGP Update message (see Forouzan figures 14.54 pg. 428 and 14.52 pg. 426)

- Unfeasible routes length (2 bytes) - length of next field
- Withdraw routes - list of all routes that must be deleted
- Path attributes length(2 bytes) - length of next field
- Path attributes - specifies the attributes of the path being announced
- Network layer reachability information - prefix length and IP address (to support CIDR)

# BGP Keepalive Message

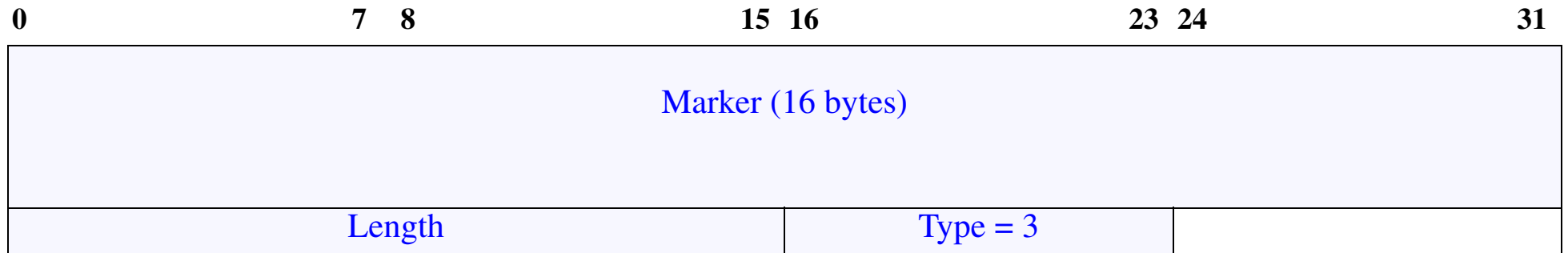

Figure 15: BGP Keepalive message (see Forouzan figures 14.55 pg. 429 and 14.52 pg. 426)

- Sent to reassure your peer that you are still alive

# BGP Notification Message

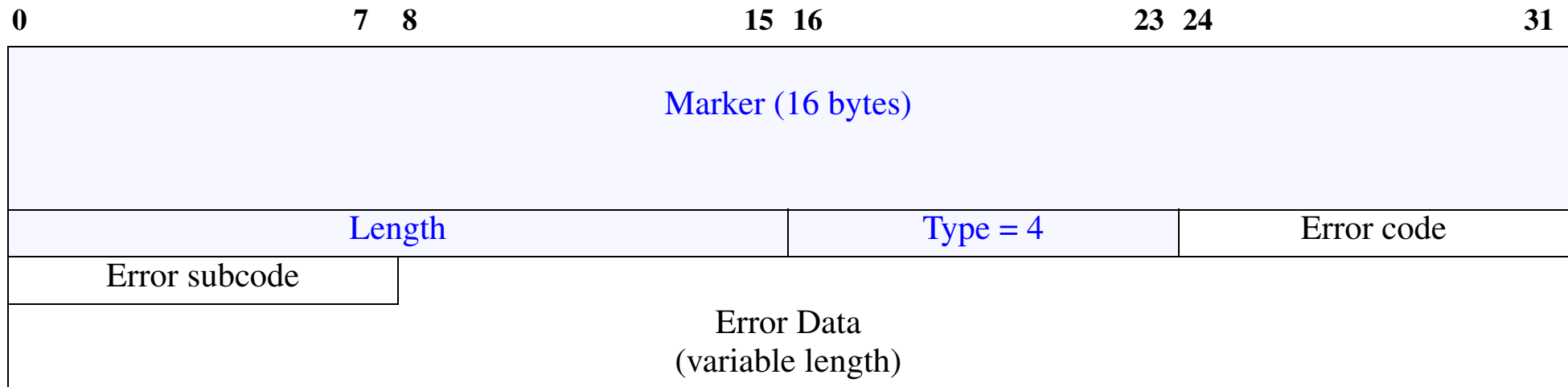

Figure 16: BGP Notification message (see Forouzan figures 14.56 pg. 429 and 14.52 pg. 426)

- Error code (1 bytes) - category of error
  - 1 = Message header error
  - 2 = Open Message error
  - 3 = Update Message error
  - 4 = Hold time expired
  - 5 = Finite state machine error
  - 6 = Cease
- Error subcode (1 bytes) - the particular error in this category
- Error Data - information about this error

# Interconnections of networks

Since different networks have different users, policies, cost structure, etc.

But, the value of a network is proportional to the (number users)<sup>2</sup> [Metcalfe's Law]

Therefore, network operators **want** to connect their networks to other networks.

⇒ Internet eXchange Points (IXs or IXPs)

List of public internet exchange points: <http://www.ep.net/ep-main.html>

For a discussion of why IXPs are important see [22]

- No internet exchange points ⇒ no internetworking!
- Cost advantages in peering
- QoS advantages

# Federal Internet eXchange (FIX)

A top-level routing domain - i.e., it does not use default routes.

Each was built around an FDDI ring which interconnected routers from each of the operators.

Each of these routers was in turn connected to the rest of the operator's network via a high speed link (often at speeds up to 45Mbps).



Note that it need not be a physical ring, but was often an FDDI switch (such as the DEC Gigaswitch/FDDI).

# Commercial Internet eXchange (CIX)

A nonprofit trade association of Public Data Internetwork Service Providers.

- a neutral forum - for forming consensus on legislation and policies
- fundamental agree for all CIX members to interconnect with on another
- no restriction on traffic between member networks
- no “settlements” or traffic charges



# Global Internet eXchange (GIX)

Global Internet eXchange (GIX), Guy Almes, Peter Ford, Peter Lothberg.

proposed in June 1992 - Stockholm D-GIX became Netnod-IX

# Some of Sweden's Internet exchange points

- Luleå Internet Exchange ⇒ Polarix <http://www.polarix.se/>
- NorrNod <http://www.norrnod.se/>
- NETNOD Internet eXchange <http://www.netnod.se/>
- RIX -GH Gävleborg Regional Internet Exchange <http://www.rix-gh.se/>
- SOL-IX - Stockholm <http://www.sol-ix.net/>

Other useful contacts:

SNUS (Swedish Network Users Society)

“... its goal, from the users perspective, to force the evolution and development of the networks and interconnections between networks, to arrange seminars, to exchange information between the members, and to write agreements with companies.”

- SOF (Swedish Operators Forum)
- North American Network Operators' Group (NANOG) <http://www.nanog.org/>
- ...

# Network Access Points (NAPs)

At the NAP a high-speed network or switch is used to interconnect a number of routers for the purpose of exchanging traffic.

Started with several NSF sponsored NAPs:

- Sprint NAP - in Pennsauken NJ
- PacBell NAP - in San Francisco
- Ameritech Advanced Data Services (AADS) {now SBC} NAP - in Chicago (ATM exchange point) <http://www.aads.net/main.html>
- MAE-East (part of MCI) - in Washington DC <http://www.mae.net/>
- MAE-West (part of MCI) - in San Jose CA

In addition to handling IP packets, NAPs were required to support InterDomain Routing Protocol (IDRP) {the ISO OSI Exterior Gateway Protocol} and route CLNP (ConnectionLess Networking Protocol) packets.

# NAPs today

Using GigE, switch fabrics, resilient packet ring (Spatial Reuse Protocol (SRP)) technology, e.g., Cisco's Dynamic Packet Transport (DPT), ... with dedicated fiber connections to/from members.

NAP managers are increasingly concerned about security, reliability, and accounting & statistics.

Various NAP have different policies, methods of dividing costs, fees, co-location of operators equipment at the NAP, etc.

# Router Arbiter Project

Router Arbiter (RA) -<http://www.ra.net> (July 1994 through March 1998)

- provide a common database of route information (network topology and policies) [Routing Arbiter Database (RADB) became Routing Assets Database (RADb) <http://www.merit.edu/nrd/services/radb.html> ]
- promote stability and manageability of networks

Instead of a full mesh connection between providers, all the providers peer with a central **router server**. A Router server (RS):

- maintains a database of all information operators need to set their routing policy (written in RIPE 181, see RFC 1786 ⇒ Routing Policy Specification Language (RPSL))  
<http://www.merit.edu/internet/documents/internet-drafts/draft-blunk-rpslng-08.txt> )
- does not forward packets or perform any switching function
- a distributed rover runs at each RS and collects information which the central network management system later queries.

# Internet Routing Registry (IRR)

- a neutral Routing Registry
- set of routing DBs which includes
  - RIPE Routing Registry (European ISPs) - <http://www.ripe.net/db/irr.html>
  - MCI Routing Registry (MCI customers)
  - CA\*net Routing Registry (CA\*net customers)
  - ANS Routing Registry (ANS customers)
  - JPRR Routing Registry (Japanese ISPs)
  - Routing Arbiter Database (RADB) (all others)
- entries are maintained by each service provider

Internet Performance and Analysis Project (IPMA) IRR Java Interface

<http://salamander.merit.edu/ipma/java/IRR.html>

# Euro6IX

The European IPv6 Internet Exchanges (Euro6IX) project [23] examined how to build an IPv6 exchange. It contains good examples of how to combine both switching and routing mechanisms to build a high performance internet exchange.

They also describe additional services which such an exchange might provide. These range from DNS to content distribution.

# Cisco's NetFlow Switching

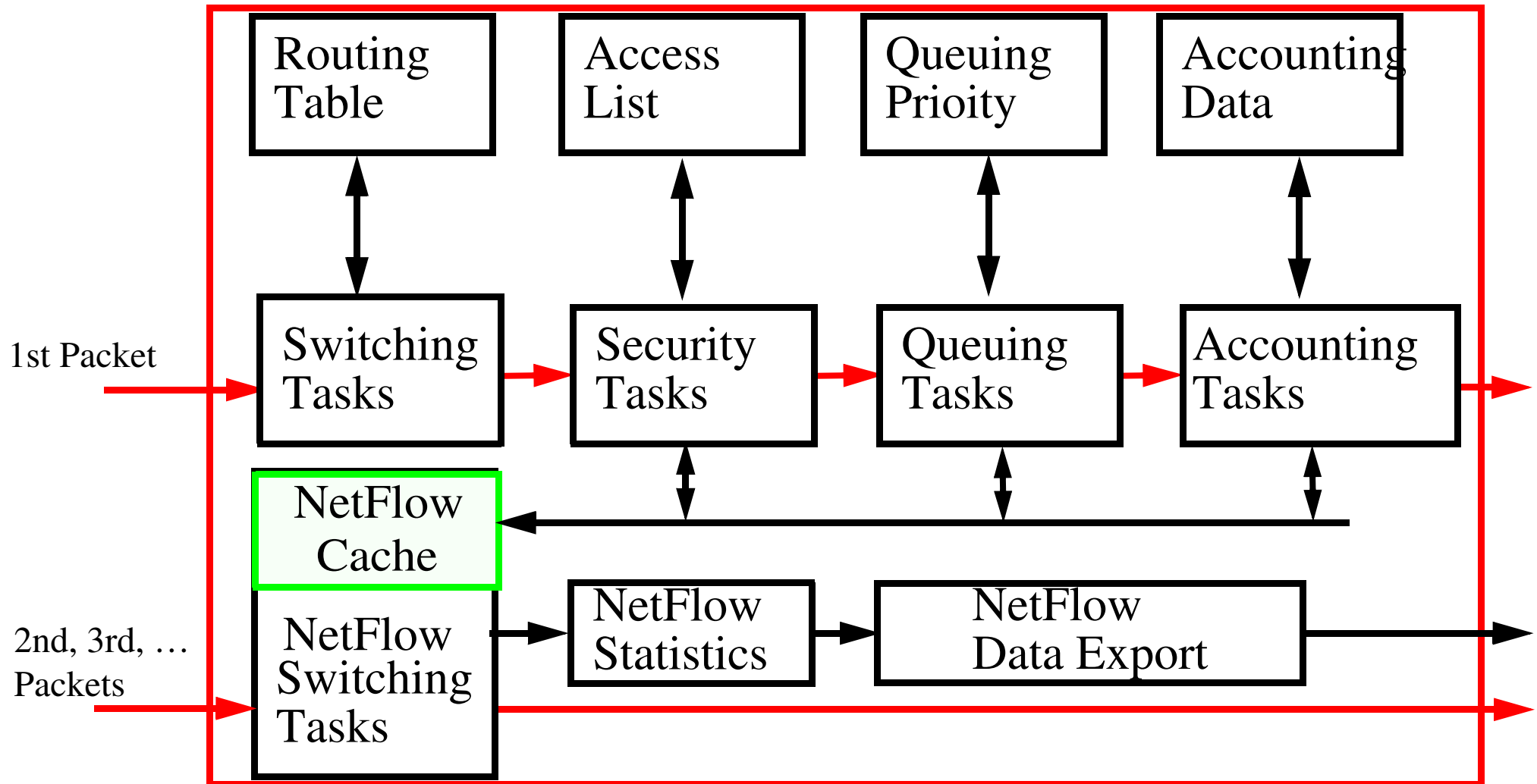

Figure 17: Cisco's NetFlow Switching



# Flows

A flow is defined as a “uni-directional stream of packets between a given source network-layer address and port number and a specific destination network-layer address and port number”.

Since many application use well known transport-layer port numbers, it is possible to identify **flows per user per application basis**.

There is a well defined Netflow Switching Developer’s Interface which allows you to get the statistics concerning the NetFlow cache and the per flow data (the later gives you essentially billing records).

A general introduction to NetFlow Switching is available at

[http://www.cisco.com/univercd/cc/td/doc/product/software/ios120/12cgcr/switch\\_c/xcp3/xcovntfl.htm](http://www.cisco.com/univercd/cc/td/doc/product/software/ios120/12cgcr/switch_c/xcp3/xcovntfl.htm)

# Cisco's Tag Switching

Combine routing with the performance of switching, based on the concept of “label swapping”, in which units of data (e.g., a packet or a cell) carry a short, fixed length label that tells switching nodes how to process the data.

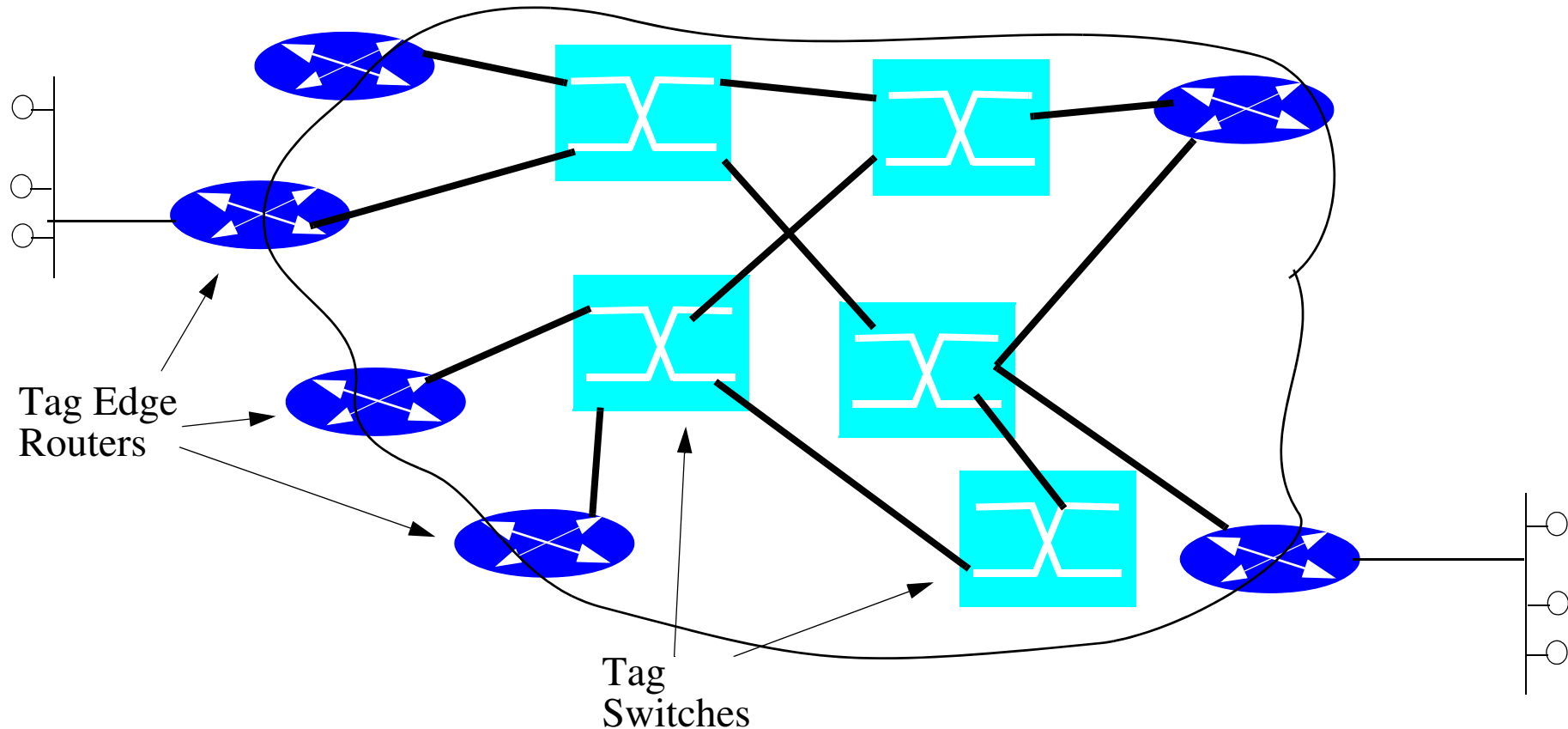

Figure 18: Tag Switching

A Tag Edge router labels a packet based on its destination, then the Tag Switches make their switching decision based on this tag, without having to look at the contents of the packet.

The Tag Edge routers and Tag Switch exchange tag data using Tag Distribution Protocol (TDP).

### **Basics of Tag switching:**

1. Tag edge routers and tag switches use standard routing protocols to identify routes through the internetwork.
2. Using the tables generated by the routing protocols the tag edge routers and switches assign and distribute tag information via the tag distribution protocol (TDP). When the Tag routers receive this TDP information they build a forwarding database.
3. When a tag edge router receives a packet it analyzes the network layer header, performs applicable network layer services, selects a route for the packet from its routing tables, applies a tag, and forwards the packet to the next hop tag switch.
4. The tag switch receives the tagged packet and switches the packet based **solely** on the tag.
5. The packet reaches the tag edge router at the egress point of the network, the tag is stripped off and the packet delivered as usual.

# Tag Locations

- in the Layer 2 header (e.g., in the VCI field for ATM cells)
- in the Layer 3 header (e.g., in the flow label field in IPv6) or
- in between the Layer 2 and Layer 3 headers

# Creating tags

Since tag switching decouples the tag distribution mechanisms from the data flows  
- the tags can be created:

- when the first traffic is seen to a destination or
- in advance - so that even the first packet can immediately be labelled.

See also: Multiprotocol Label Switching (MPLS) and Generalized Multi-Protocol Label Switching (GMPLS)

# Routers do more than routing

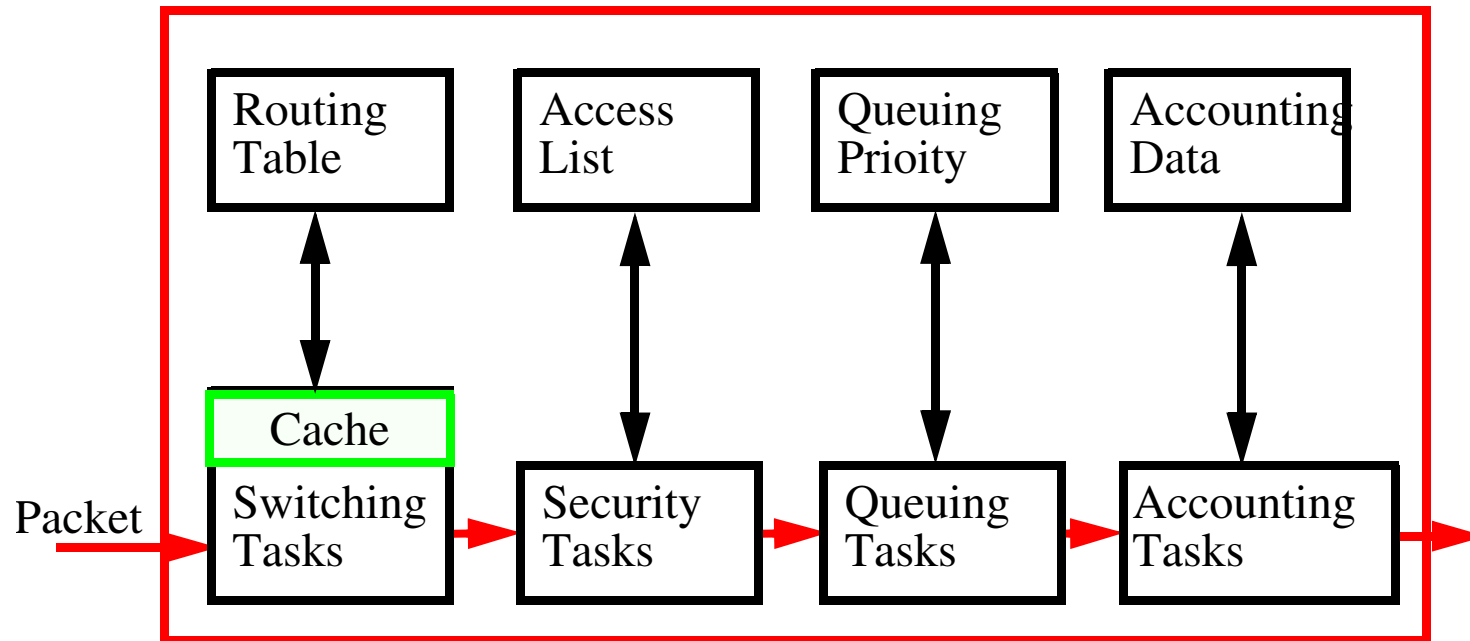

Figure 19: Basic steps in Routing

Earlier we have looked at the routing step, but today much of the excitement is in the details of the other functions. For example, in order to support various QoS features you might want to use more sophisticated queue management: Weighted Round Robin, Fair Queuing, Weighted Fair Queuing, Random Early Detection (RED), Weighted RED, . . . .

# Summary

This lecture we have discussed:

- IP routing
  - Dynamic routing protocols
    - RIP, OSPF, BGP, CIDR
  - Cisco's NetFlow Switching and Tag Switching
- NAPs and other interconnect points

# References

- [1] J. Hawkinson and T. Bates, “Guidelines for creation, selection, and registration of an Autonomous System (AS)”, IETF RFC 1930, March 1996 <http://www.ietf.org/rfc/rfc1930.txt>
- [2] C. Hedrick, “Routing Information Protocol”, IETF RFC 1058, June 1988 <http://www.ietf.org/rfc/rfc1058>
- [3] G. Malkin, “RIP Version 2: Carrying Additional Information”, IETF RFC 1388, January 1993 <http://www.ietf.org/rfc/rfc1388>
- [4] G. Malkin, “RIP Version 2”, IETF RFC 2453, November 1998 <http://www.ietf.org/rfc/rfc2453>
- [5] Charles L. Hedrick, “An Introduction to IGRP”, Cisco, Document ID: 26825, Technology White Paper, August 1991 <http://www.cisco.com/warp/public/103/5.html>
- [6] “Enhanced Interior Gateway Routing Protocol”, Cisco, Technology White Paper, Document ID: 16406, April 19, 2005 <http://www.cisco.com/warp/public/103/eigrp-toc.html>
- [7] J. Moy, “OSPF Version 2”, IETF RFC 2328, April 1998 <http://www.ietf.org/rfc/rfc2328.txt>
- [8] “OSPF Design Guide”, Cisco, Technology White Paper, Document ID: 7039, August 26, 2004 <http://www.cisco.com/warp/public/104/1.html>
- [9] K. Lougheed and Y. Rekhter, “A Border Gateway Protocol 3 (BGP-3)”, IETF RFC 1267, October 1991 <http://www.ietf.org/rfc/rfc1267.txt>
- [10] Y. Rekhter and T. Li (editors), “A Border Gateway Protocol 4 (BGP-4)”, IETF RFC 1654, July 1994 <http://www.ietf.org/rfc/rfc1654.txt>
- [11] Y. Rekhter and T. Li (editors), “A Border Gateway Protocol 4 (BGP-4)”, IETF RFC 1771, March 1995 <http://www.ietf.org/rfc/rfc1771.txt>
- [12] John W. Stewart III, *BGP4: Inter-Domain Routing in the Internet*, Addison-Wesley, 1999, ISBN: 0-201-37951-1
- [13] Bassam Halabi, *Internet Routing Architectures*, Cisco Press, ISBN 1-56205-652-2



- [14] R. Hinden (Editor), “Applicability Statement for the Implementation of Classless Inter-Domain Routing (CIDR)”, IETF RFC 1517, September 1993 <http://www.ietf.org/rfc/rfc1517.txt>
- [15] Y. Rekhter and T. Li (Editors), “An Architecture for IP Address Allocation with CIDR”, IETF RFC 1518. September 1993 <http://www.ietf.org/rfc/rfc1518.txt>
- [16] V. Fuller, T. Li, J. Yu, and K. Varadhan, “Classless Inter-Domain Routing (CIDR): an Address Assignment and Aggregation Strategy”, IETF RFC 1519, September 1993 <http://www.ietf.org/rfc/rfc1519.txt>
- [17] Y. Rekhter and C. Topolcic, “Exchanging Routing Information Across Provider Boundaries in the CIDR Environment”, IETF RFC 1520, September 1993 <http://www.ietf.org/rfc/rfc1520.txt>
- [18] R. Chandra, P. Traina, and T. Li, “BGP Communities Attribute”, IETF RFC 1997, August 1996 <http://www.ietf.org/rfc/rfc1997.txt>
- [19] E. Chen and T. Bates, “An Application of the BGP Community Attribute in Multi-home Routing”, IETF RFC 1998, August 1996 <http://www.ietf.org/rfc/rfc1998.txt>
- [20] Iljitsch van Beijnum, web site <http://www.bgpexpert.com/>, last modified April 28, 2005 12:00:00 PM
- [21] Iljitsch van Beijnum, *BGP*, O’Reilly, 1st Edition September 2002, ISBN 0-596-00254-8
- [22] “Internet Exchange Points: Their Importance to Development of the Internet and Strategies for their Deployment: The African Example”, Global Internet Policy Initiative (GIPI), 6 June 2002 (revised 3 May 2004), <http://www.internetpolicy.net/practices/ixp.pdf>
- [23] Cesar Olvera Morales, Jordi Palet Martinez, Alvaro Vives, Alain Baudot, Carlos Parada, Raffaele D’Albenzio, Mario Morelli, David Fernandez, and Tomás de Miguel, Specification of the Internal Network Architecture of each IX Point, Deliverable D2.1, Euro6IX: European IPv6 Internet Exchanges Backbone Project, IST-2001-32161, version 4.4, 30 July 2002 <http://www.euro6ix.org/Reports/public/euro6ix pu d2 1 v4 4.pdf>

# IK1550 Internetworking/Internetteknik

## Spring 2010, Period 4

### Module 8: Multicasting and RSVP

Lecture notes of G. Q. Maguire Jr.



KTH Information and  
Communication Technology

© 2010 G.Q.Maguire Jr. .

All rights reserved. No part of this course may be reproduced, stored in a retrieval system, or transmitted, in any form or by any means, electronic, mechanical, photocopying, recording, or otherwise, without written permission of the author.

Last modified: 2010.03.21:17:37

# Outline

- Multicast
- IGMP
- RSVP

# Multicast and IGMP

# Broadcast and Multicast

Traditionally the Internet was designed for unicast communication (one sender and one receiver) communication.

Increasing use of multimedia (video and audio) on the Internet

- **One-to-many** and **many-to-many** communication is increasing
- In order to support these in a *scalable* fashion we use **multicasting**.
- Replicating UDP packets **where** paths **diverge** (i.e., split)

**MBONE** was an experimental multicast network which operated for a number of years. (see for example <http://www-mice.cs.ucl.ac.uk/multimedia/software/> and

<http://www.ripe.net/ripe/wg/mbone/home.html> )

Multicasting is useful for:

- Delivery to multiple recipients
  - reduces traffic, otherwise each would have to be sent its own copy (“internet radio/TV”)
- Solicitation of service (service/server discovery)
  - Not doing a broadcast saves interrupting many clients

# Filtering up the protocol stack

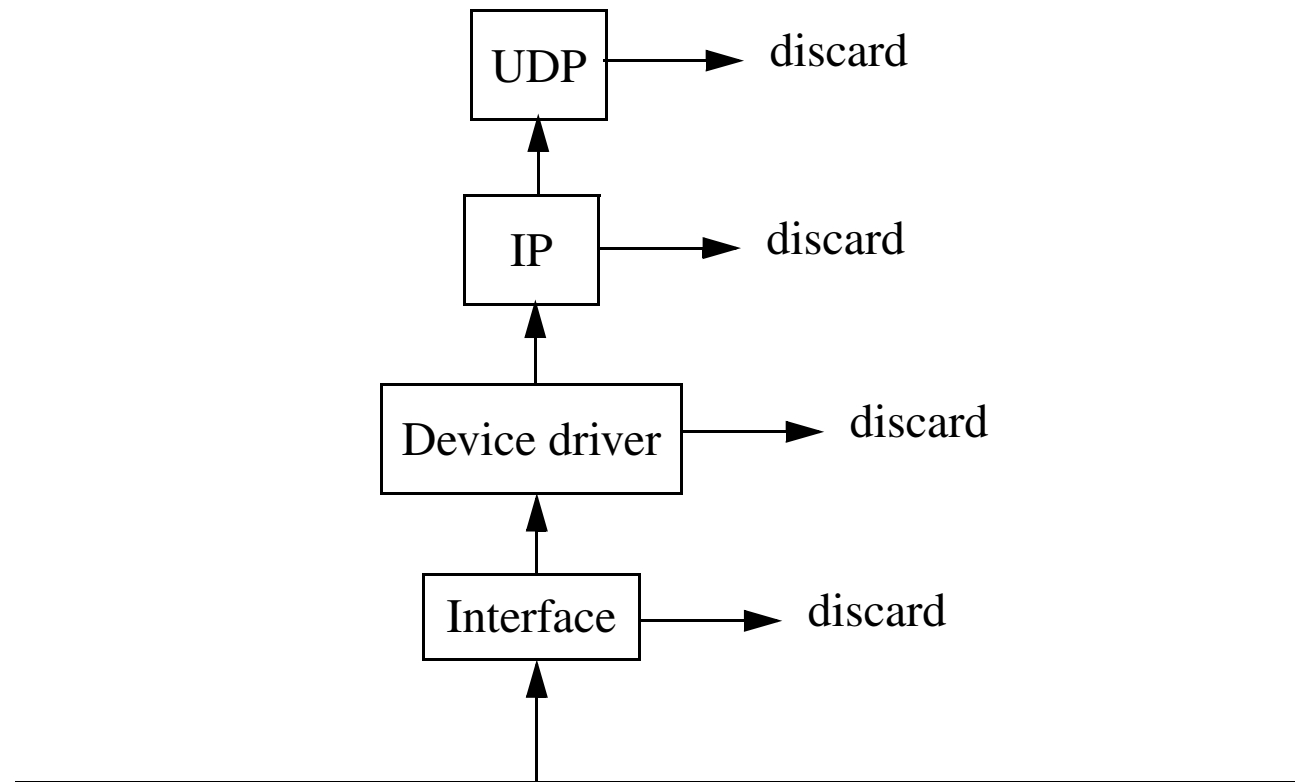

Figure 1: Filtering which takes place as you go up the TCP/IP stack  
(see Stevens, Volume 1, figure 12.1, pg. 170)

We would like to filter as soon as possible **to avoid load** on the machine.

# Broadcasting

- Limited Broadcast
  - IP address: 255.255.255.255
  - **never** forwarded by routers
  - What if you are multihomed? (i.e., attached to several networks)
    - Most BSD systems just send on first configured interface
    - routed and rwhod - determine all interfaces on host and send a copy on each (which is capable of broadcasting)
- Net-directed Broadcast
  - IP address: netid.255.255.255 or net.id.255.255 or net.i.d.255 (depending on the class of the network)
  - routers **must** forward
- Subnet-Directed Broadcast
  - IP address: netid | subnetid | hostID, where hostID = all ones
- All-subnets-directed Broadcast
  - IP address: netid | subnetid | hostID, where hostID = all ones and subnetID = all ones
  - generally regarded as obsolete!

To send a UDP datagram to a broadcast address set **SO\_BROADCAST**

# Other approaches to One-to-Many and Many-to-Many communication

Connection oriented approaches have problems:

- large user burden
- have to know other participants
- have to order links in advance
- poor scaling, worst case  $O(N^2)$



# Alternative centralized model

CU-SeeME uses another model - a Reflector (a centralized model)

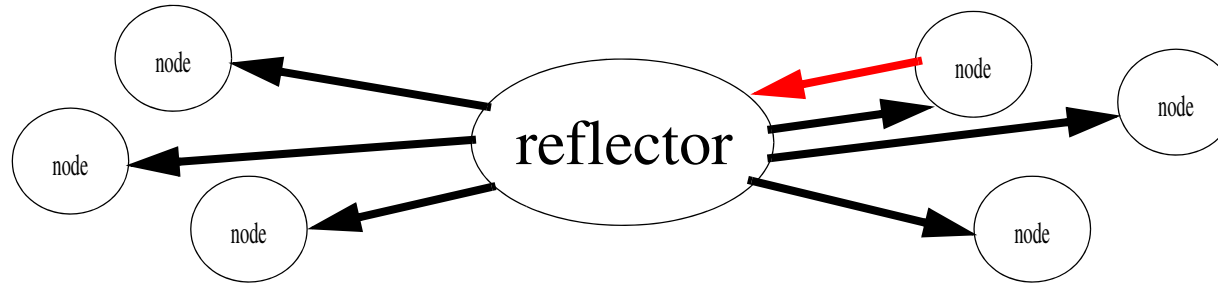

Figure 2: Reflector

- All sites send to one site (the reflector) overcomes the  $N^2$  problems
- The reflector sends copies to all sites

Problems:

- Does **not** scale well
- Multiple copies sent over the same link
- Central site must know all who participate

Behavior could be changed by explicitly building a tree of reflectors - but then you are moving over to Steve Deering's model.

# Multicast Backbone (MBONE)

Expanding multicasting across WANs

World-wide, IP-based, real-time conferencing over the Internet (via the MBONE) in daily use for several years with more than 20,000 users in more than 1,500 networks in events carrier to 30 countries.

For a nice paper examining multicast traffic see: “Measurements and Observations of IP Multicast Traffic” by Bruce A. Mah <bmah@CS.Berkeley.EDU>, The Tenet Group, University of California at Berkeley, and International Computer Science Institute, CSD-94-858, 1994, 12 pages:

<http://www.kitchenlab.org/www/bmah/Papers/Ipmcast-TechReport.pdf/>

# IP Multicast scales well

- End-nodes know nothing about topology
  - Dynamically changes of topology possible, hosts join and leave as they wish
- Routers know nothing about “conversations”
  - changes can be done without global coordination
  - no end-to-end state to move around

## Participants view of Multicast

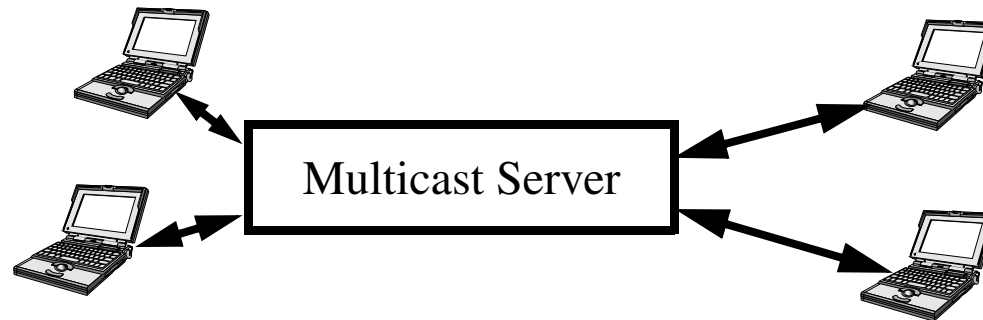

Figure 3: MBONE behaves as if there were a multicast server, but this functionality is **distributed** not centralized.

# Core Problem

How to do efficient multipoint distribution (i.e., at most one copy of a packet crossing any particular link) without exposing topology to end-nodes



## Applications

- Conference calls (without sending N copies sent for N recipients)
- Dissemination of information (stock prices, "radio stations", ...)
- Dissemination of one result for many similar requests (boot information, video)
- Unix tools:
  - nv - network video
  - vat - visual audio tool
  - wb - whiteboard
  - sd - session directory
  - ...

# Steve Deering's Multicast

Dynamically constructs efficient delivery trees from sender(s) to receiver(s)

- Key is to compute a spanning tree of multicast routers

Simple service model:

- receivers announce interest in some multicast address
- senders just send to that address
- routers conspire to deliver sender's data to all interested receivers
  - so the real work falls once again to the **routers**, not the **end nodes**
  - Note that the assumption here is that it is worth loading the routers with this extra work, because it reduces the traffic which has to be carried.

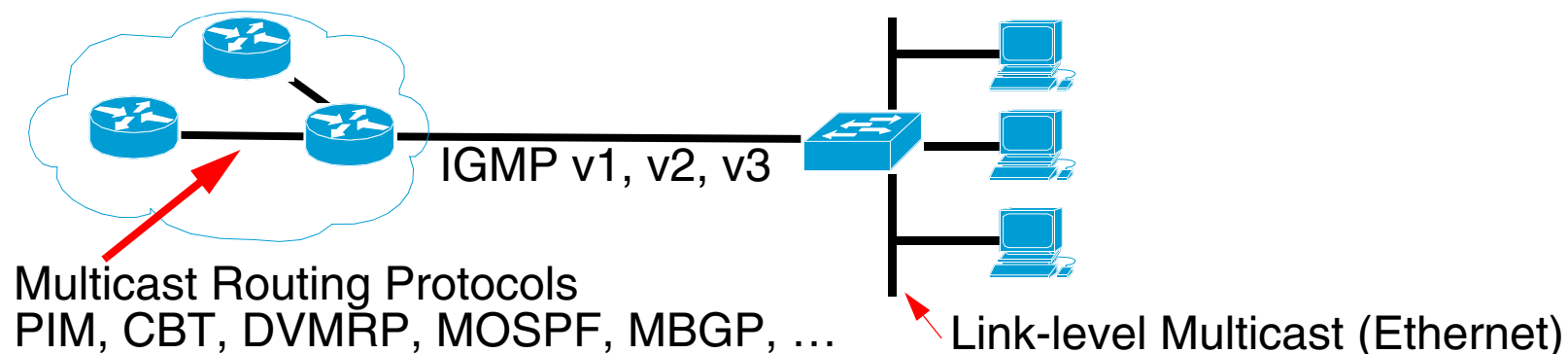

Figure 4: IP Multicast Service Model

# IP WAN Multicast Requirements

- Convention for recognizing IP multicast
- Convention for mapping IP to LAN address
- Protocol for end nodes to inform their adjacent routers,
- Protocol for routers to inform neighbor routers
- Algorithm to calculate a spanning tree for message flow
- Transmit data packets along this tree

# Multicasting IP addresses

## Multicast Group Addresses - “Class D” IP address

- High 4 bits are 0x1110; which corresponds to the range 224.0.0.0 through 239.255.255.255
- **host group**  $\equiv$  set of hosts listening to a given address
  - membership is dynamic - hosts can enter and leave at will
  - no restriction on the number of hosts in a host group
  - a host need not belong in order to send to a given host group
  - permanent host groups - assigned well know addresses by IANA
    - 224.0.0.1 - all systems on this subnet
    - 224.0.0.2 - all routers on this subnet
    - 224.0.0.4 - DVMRP routers
    - 224.0.0.9 - RIP-2 routers
    - 224.0.1.1 - Network Time Protocol (NTP) - see RFC 1305 and RFC 1769 (SNTP)
    - 224.0.1.2 - SGI's dogfight application

# Internet Multicast Addresses

<http://www.iana.org/assignments/multicast-addresses> listed in DNS under MCAST.NET and 224.IN-ADDR.ARPA.

- 224.0.0.0 - 224.0.0.255 (224.0.0/24) Local Network Control Block
- 224.0.1.0 - 224.0.1.255 (224.0.1/24) Internetwork Control Block
- 224.0.2.0 - 224.0.255.0 AD-HOC Block
- 224.1.0.0 - 224.1.255.255 (224.1/16) ST Multicast Groups
- 224.2.0.0 - 224.2.255.255 (224.2/16) SDP/SAP Block
- 224.3.0.0 - 224.251.255.255 Reserved
- 239.0.0.0/8 Administratively Scoped
  - 239.000.000.000-239.063.255.255 Reserved
  - 239.064.000.000-239.127.255.255 Reserved
  - 239.128.000.000-239.191.255.255 Reserved
  - 239.192.000.000-239.251.255.255 Organization-Local Scope
  - 239.252.0.0/16 Site-Local Scope (reserved)
  - 239.253.0.0/16 Site-Local Scope (reserved)
  - 239.254.0.0/16 Site-Local Scope (reserved)
  - 239.255.0.0/16 Site-Local Scope
  - 239.255.002.002 rasadv



# Converting Multicast Group to Ethernet Address

Could have been a simple mapping of the 28 bits of multicast group to 28 bits of Ethernet multicast space (which is  $2^{27}$  in size), but this would have meant that IEEE would have to allocate multiple blocks of MAC addresses to this purpose, but:

- they didn't want to allocate multiple blocks to one organization
- a block of  $2^{24}$  addresses costs \$1,000 ==> \$16K for  $2^{27}$  addresses

# Mapping Multicast (Class D) address to Ethernet MAC Address

Solution IANA has one block of ethernet addresses 00:00:5e as the high 24 bits

- they decided to give 1/2 this address space to multicast -- thus multicast has the address range: 00:00:5e:00:00:00 to 00:00:5e:7f:ff:ff
- since the first bit of an ethernet multicast has a low order 1 bit (which is the first bit transmitted in link layer order), the addresses are 01:00:5e:00:00:00 to 01:00:5e:7f:ff:ff
- thus there are 23 bits available for use by the 28 bits of the multicast group ID; we just use the **bottom 23 bits**
  - therefore 32 different multicast group addresses map to the **same** ethernet address
  - the IP layer will have to sort these 32 out
  - thus although the filtering is not complete, it is very significant

The multicast datagrams are delivered to **all** processes that belong to the same multicast group.

To extend beyond a single subnet we use IGMP.

# Problems

Unfortunately many links do not support link layer multicasts at all!

For example:

- ATM
- Frame relay
- many cellular wireless standards
- ...

# IGMP: Internet Group Management Protocol

IGMP: Internet Group Management Protocol (RFC 1112) [2]:

- Used by hosts and routers to know which hosts currently belong to which multicast groups.
- multicast routers have to know which interface to forward datagrams to
- IGMP like ICMP is part of the IP layer and is transmitted using IP datagrams (protocol = 2) |

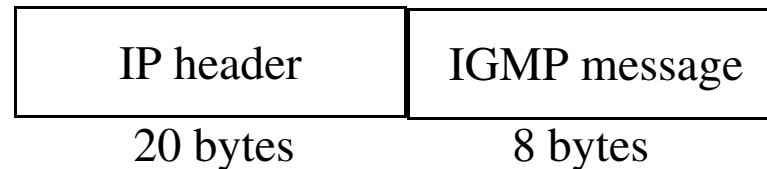
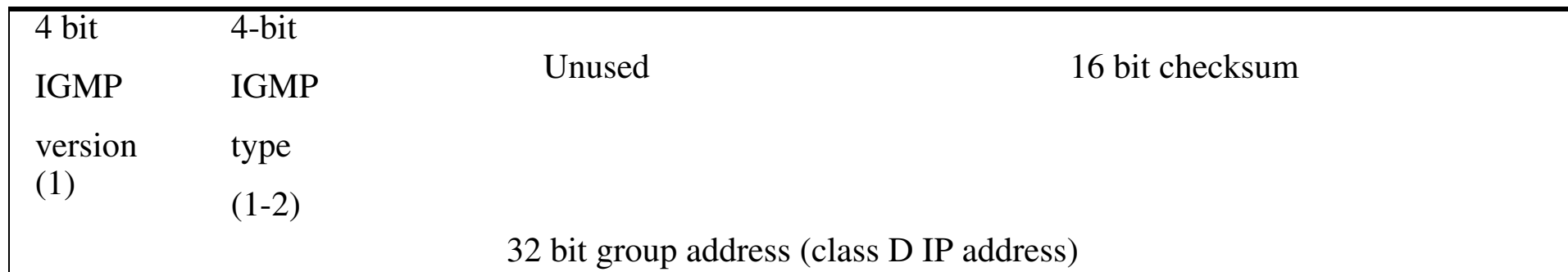

Figure 5: Encapsulation of IGMP message in IP datagram (see Stevens, Vol. 1, figure 13.1, pg. 179)



- type =1  $\Rightarrow$  query sent by a router, type =2  $\Rightarrow$  response sent by a host

# How does IGMP fit into the protocol stack

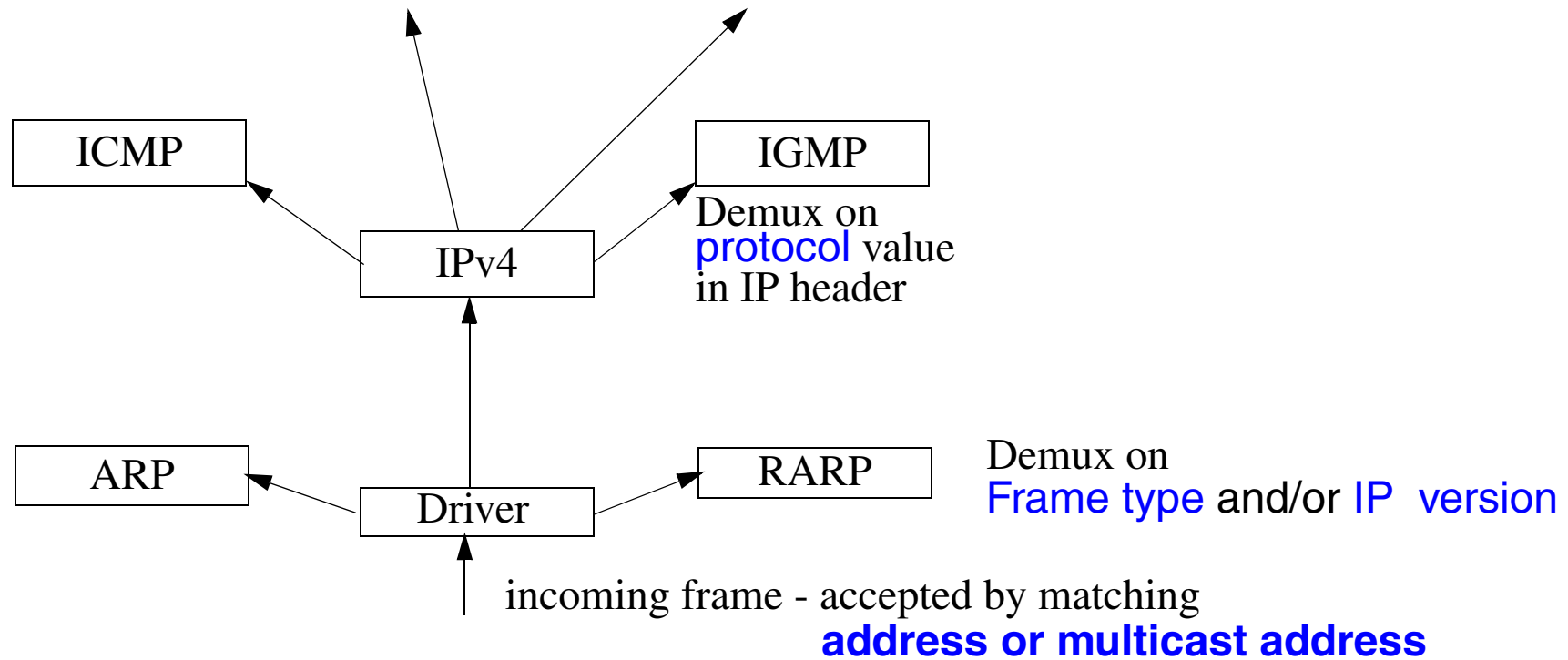

Figure 6: IGMP - adapted from earlier figure (See “Demultiplexing” on page 41.)

So it used IP packets with a protocol value of 2.

# Joining a Multicast Group

- a **process** joins a multicast group on a **given** interface
- host keeps a table of all groups which have a reference count  $\geq 1$

## IGMP Reports and Queries

- Hosts sends a report when **first** process joins a given group
- Nothing is sent when processes leave (not even when the last leaves), but the host will no longer send a report for this group
- IGMP router sends queries (to address 224.0.0.1) periodically (one out each interface), the group address in the query is 0.0.0.0

In response to a query, a host sends a IGMP report for every group with at least one process

## Routers

- Note that routers have to listen to all  $2^{23}$  link layer multicast addresses!
- Hence they listen promiscuously to all LAN multicast traffic

# IGMP Implementation Details

In order to improve its efficiency there are several clever features:

- Since initial reports could be lost, they are resent after a random time [0, 10 sec]
- Response to queries are also delayed randomly - but if a node hears someone else report membership in a group it is interested in, its response is cancelled

Note: multicast routers don't care which host is a member of which group; only that *someone* attached to the subnet on a given interface is!

## Time to Live

- TTL generally set to 1, but you can perform an [expanding ring search](#) for a server by increasing the value
- Addresses in the special range 224.0.0.0 through 224.0.0.255 - should never be forwarded by routers - regardless of the TTL value

## All-Hosts Group

- all-hosts group address 224.0.0.1 - consists of all multicast capable hosts and routers on a given physical network; membership is *never* reported (sometimes this is called the “all-systems multicast address”)

## All-Routers Group

- all-routers group address 224.0.0.2

# Group membership State Transitions

adapted from Comer figure 17.4 pg. 330

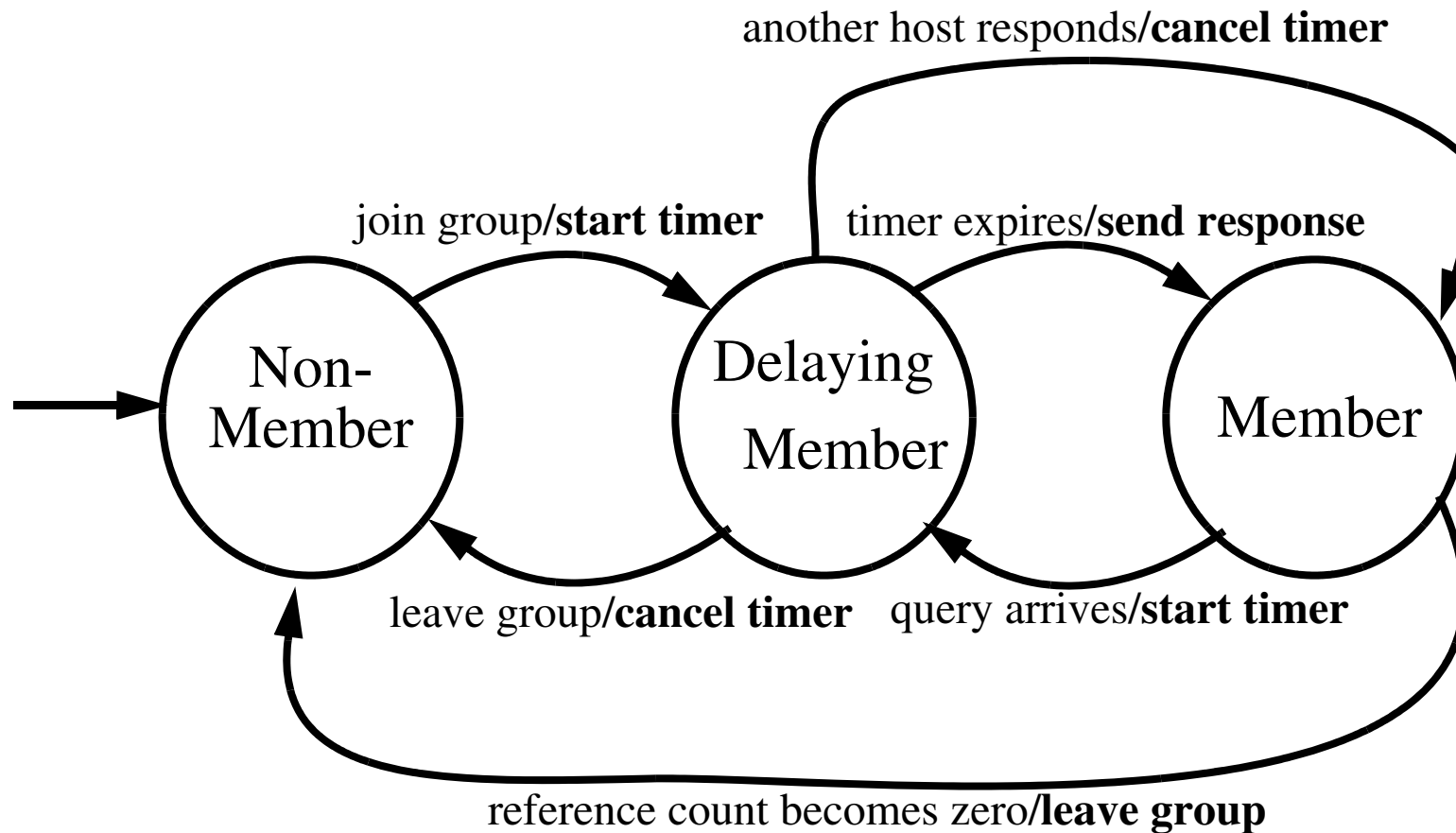



# IGMP Version 2 [3]

Allows a host to send a message (to address 224.0.0.2) when they want to explicitly leave a group -- after this message the router sends a *group-specific* query to ask if there is anyone still interested in listening to this group.

- however, the router may have to ask multiple times because this query could be lost
- hence the leave is not immediate -- even if there had been only one member (since the router can't know this)

# IGMP Version 3 [4]

- Joining a multicast group, but with a specified set of sender(s) -- so that a client can limit the set of senders which it is interested in hearing from (i.e., source filtering)
- all IGMP replies are now set to a single layer 2 multicast address (e.g., 224.0.0.22) which all IGMPv3-capable multicast routers listen to:
  - because most LANs are now *switched* rather than shared media -- it uses less bandwidth to **not** forward all IGMP replies to all ports
  - most switches now support **IGMP snooping** -- i.e., the switch is IGMP aware and knows which ports are part of which multicast group (this requires the switch to know which ports other switches and routers are on -- so it can forward IGMP replies to them)
    - switches can listen to this specific layer 2 multicast address - rather than having to listen to all multicast addresses
  - it is thought that rather than have end nodes figure out if all the multicast senders which it is interested in have been replied to - simply make the switch do this work.

# IGMP - ethereal

| No. . | Time       | Source          | Destination     | Protocol | Info                 |
|-------|------------|-----------------|-----------------|----------|----------------------|
| 1     | 0.000000   | 130.237.15.194  | 224.0.0.1       | IGMP     | V2 Membership Query  |
| 2     | 0.632486   | 130.237.15.225  | 239.255.255.250 | IGMP     | V2 Membership Report |
| 3     | 0.727178   | 130.237.15.218  | 239.255.255.250 | IGMP     | V2 Membership Report |
| 4     | 1.910951   | 130.237.15.227  | 224.0.0.252     | IGMP     | V2 Membership Report |
| 5     | 6.953857   | 130.237.15.229  | 224.0.1.60      | IGMP     | V1 Membership Report |
| 6     | 60.000053  | 130.237.15.194  | 224.0.0.1       | IGMP     | V2 Membership Query  |
| 7     | 61.998827  | 130.237.15.227  | 224.0.0.252     | IGMP     | V2 Membership Report |
| 8     | 66.711434  | 130.237.15.225  | 239.255.255.250 | IGMP     | V2 Membership Report |
| 9     | 66.953288  | 130.237.15.229  | 224.0.1.60      | IGMP     | V1 Membership Report |
| 10    | 120.004228 | 130.237.15.194  | 224.0.0.1       | IGMP     | V2 Membership Query  |
| 11    | 120.872195 | 130.237.15.218  | 239.255.255.250 | IGMP     | V2 Membership Report |
| 12    | 126.952839 | 130.237.15.229  | 224.0.1.60      | IGMP     | V1 Membership Report |
| 13    | 129.597716 | 130.237.15.227  | 224.0.0.252     | IGMP     | V2 Membership Report |
| 14    | 154.655463 | 211.105.145.186 | 224.0.0.2       | IGMP     | V2 Leave Group       |
| 15    | 154.656338 | 211.105.145.186 | 224.0.0.2       | IGMP     | V2 Leave Group       |
| 16    | 180.004408 | 130.237.15.194  | 224.0.0.1       | IGMP     | V2 Membership Query  |
| 17    | 180.943331 | 130.237.15.217  | 239.255.255.250 | IGMP     | V2 Membership Report |

⊞ Frame 1 (60 bytes on wire, 60 bytes captured)

Figure 7: IGMP packets as seen with Ethereal

# Frame 1: IGMP Membership Query

Ethernet II, Src: 00:02:4b:de:ea:d8, Dst: 01:00:5e:00:00:01  
Destination: 01:00:5e:00:00:01 (01:00:5e:00:00:01)  
Source: 00:02:4b:de:ea:d8 (Cisco\_de:ea:d8)  
Type: IP (0x0800)

Internet Protocol, Src Addr: 130.237.15.194 (130.237.15.194), Dst  
Addr: 224.0.0.1 (224.0.0.1)

Version: 4

Header length: 20 bytes  
Differentiated Services Field: 0xc0 (DSCP 0x30: Class Selector  
6; ECN: 0x00)

Total Length: 28

Identification: 0x6fa3 (28579)

Flags: 0x00

Fragment offset: 0

Time to live: 1

Protocol: IGMP (0x02)

Header checksum: 0xd6cc (correct)

Source: 130.237.15.194 (130.237.15.194)

Destination: 224.0.0.1 (224.0.0.1)

Internet Group Management Protocol

IGMP Version: 2

Type: Membership Query (0x11)

Max Response Time: 10.0 sec (0x64)

Header checksum: 0xee9b (correct)

Multicast Address: 0.0.0.0 (0.0.0.0)

# Frame 2: IGMP v2 Membership Report

Ethernet II, Src: 00:06:1b:d0:98:c6, Dst: 01:00:5e:7f:ff:fa  
Destination: 01:00:5e:7f:ff:fa (01:00:5e:7f:ff:fa)  
Source: 00:06:1b:d0:98:c6 (Portable\_d0:98:c6)  
Type: IP (0x0800)

Internet Protocol, Src Addr: 130.237.15.225 (130.237.15.225), Dst  
Addr: 239.255.255.250 (239.255.255.250)

Version: 4

Header length: 24 bytes

Differentiated Services Field: 0x00 (DSCP 0x00: Default; ECN: 0x00)

Total Length: 32

Identification: 0x1f8b (8075)

Flags: 0x00

Time to live: 1

Protocol: IGMP (0x02)

Header checksum: 0x8284 (correct)

Source: 130.237.15.225 (130.237.15.225)

Destination: 239.255.255.250 (239.255.255.250)

Options: (4 bytes)

Router Alert: Every router examines packet

Internet Group Management Protocol

IGMP Version: 2

Type: Membership Report (0x16)

Max Response Time: 0.0 sec (0x00)

Header checksum: 0xfa04 (correct)

Multicast Address: 239.255.255.250 (239.255.255.250)

# Frame 12: IGMP v1 Membership Report

```
Ethernet II, Src: 00:01:e6:a7:d3:b9, Dst: 01:00:5e:00:01:3c
  Destination: 01:00:5e:00:01:3c (01:00:5e:00:01:3c)
  Source: 00:01:e6:a7:d3:b9 (Hewlett-_a7:d3:b9)
  Type: IP (0x0800)
Internet Protocol, Src Addr: 130.237.15.229 (130.237.15.229), Dst
Addr: 224.0.1.60 (224.0.1.60)
  Version: 4
  Header length: 20 bytes
  Differentiated Services Field: 0x00 (DSCP 0x00: Default; ECN:
0x00)
  Total Length: 28
  Identification: 0x01f6 (502)
  Flags: 0x00
  Fragment offset: 0
  Time to live: 1
  Protocol: IGMP (0x02)
  Header checksum: 0x43dc (correct)
  Source: 130.237.15.229 (130.237.15.229)
  Destination: 224.0.1.60 (224.0.1.60)
Internet Group Management Protocol
  IGMP Version: 1
  Type: Membership Report (0x12)
  Header checksum: 0x0cc3 (correct)
  Multicast Address: 224.0.1.60 (224.0.1.60)
```

# Frame 15: IGMP v2 Leave Group

Ethernet II, Src: 00:02:8a:78:91:8f, Dst: 01:00:5e:00:00:02  
Destination: 01:00:5e:00:00:02 (01:00:5e:00:00:02)  
Source: 00:02:8a:78:91:8f (AmbitMic\_78:91:8f)  
Type: IP (0x0800)

Internet Protocol, Src Addr: 211.105.145.186 (211.105.145.186), Dst  
Addr: 224.0.0.2 (224.0.0.2)

Version: 4  
Header length: 24 bytes  
Differentiated Services Field: 0x00 (DSCP 0x00: Default; ECN: 0x00)  
Total Length: 32  
Identification: 0x9391 (37777)  
Flags: 0x00  
Fragment offset: 0  
Time to live: 1

Protocol: IGMP (0x02)  
Header checksum: 0x4c20 (correct)  
Source: 211.105.145.186 (211.105.145.186)  
Destination: 224.0.0.2 (224.0.0.2)  
Options: (4 bytes)

Router Alert: Every router examines packet

Internet Group Management Protocol

IGMP Version: 2  
Type: Leave Group (0x17)  
Max Response Time: 0.0 sec (0x00)  
Header checksum: 0xff71 (correct)  
Multicast Address: 239.192.249.204 (239.192.249.204)

# Multicast routing

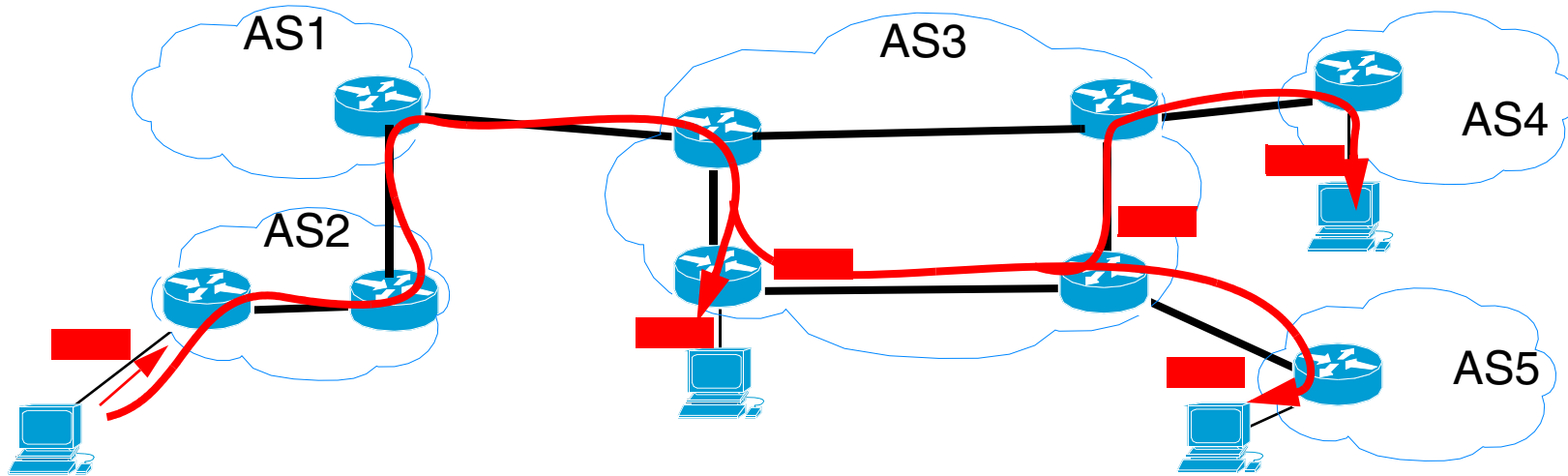

Figure 8: Multicast routing: **packet** replicated by the routers -- not the hosts

- packet **forwarded** one or more interfaces
  - router **replicates** the packet as necessary
- need to build a **delivery tree** - to decide on which paths to forward



# Therefore a Multicast Router

- Listens to **all multicast traffic** and forwards *if* necessary
  - Listens **promiscuously** to all LAN multicast traffic
- Listens to **all multicast addresses**
  - For an ethernet this means all  $2^{23}$  link layer multicast addresses
- Communicates with:
  - directly connected **hosts** via **IGMP**
  - **other multicast routers** with **multicast routing protocols**

# Multicasting

Example: Transmitting a file from C to A, B, and D.

✘ Using point-to-point transfer, some links will be used more than once to send the same file

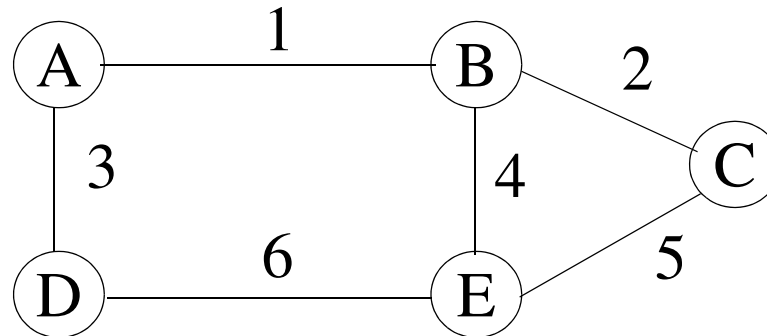

✔ Using Multicast

| Point-to-point |   |   |   |   |       |           |
|----------------|---|---|---|---|-------|-----------|
| Link           | A | B | E | D | Total | Multicast |
| 1              | 1 |   |   |   | 1     | 1         |
| 2              | 1 | 1 |   |   | 2     | 1         |
| 5              |   |   | 1 | 1 | 2     | 1         |
| 6              |   |   |   | 1 | 1     | 1         |
|                | 2 | 1 | 1 | 2 |       | 4         |

# Multicast Routing - Flooding

- maintaining a list of recently seen packets (last 2 minutes), if it has been seen before, then delete it, otherwise copy to a cache/database and send a copy on all (except the incoming) interface.

## ✗ Disadvantages:

- ◆ Maintaining a list of “last-seen” packets. This list can be fairly long in high speed networks
- ◆ The “last-seen” lists guarantee that a router will not forward the same packet twice, but it certainly does not guarantee that the router will receive a packet only once.

## ✓ Advantages

- ◆ Robustness
- ◆ It does not depend on any routing tables.

# Delivery Trees: different methods

- Source-based Trees
  - Notation: (S, G)  $\Rightarrow$  only specific sender(s) [S= source, G=Group]
  - Uses memory proportional to  $O(S \cdot G)$ , can find optimal paths  $\Rightarrow$  minimizes delay
- Group Shared Trees
  - Notation: (\*, G)  $\Rightarrow$  All senders
  - Uses less memory ( $O(G)$ ), but uses suboptimal paths  $\Rightarrow$  higher delay
- Data-driven
  - Build only **when data packets are sent**
- Demand-driven
  - Build the tree as members **join**

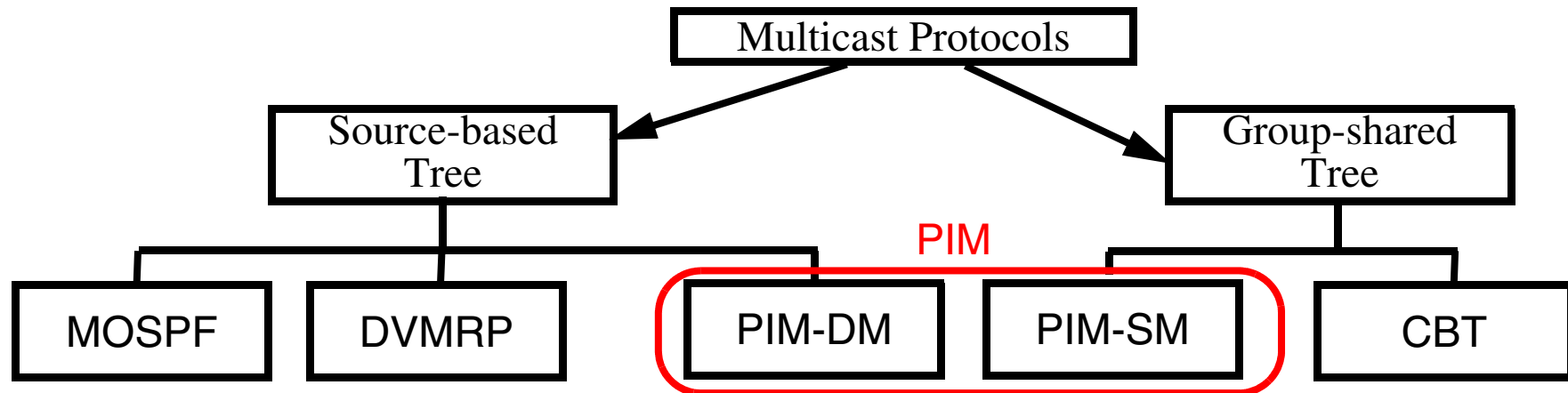
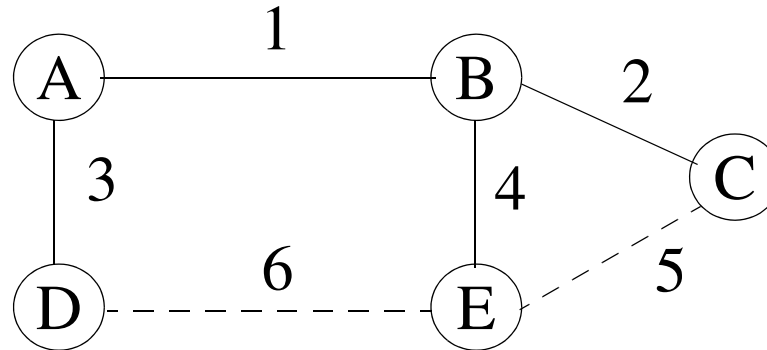

Figure 9: Taxonomy of Multicast Routing Protocols (see Forouzan figure 15.7 pg. 444)

# Multicast Routing - Spanning Trees

The “spanning tree” technique is used by “media-access-control (MAC) bridges”.

- Simply build up an “overlay” network by marking some links as “part of the tree” and other links as “unused” (produces a loopless graph).



## Drawbacks

- ✗ It does not take into account group membership
- ✗ It concentrates all traffic into a small subset of the network links.

# Link-State Multicast: MOSPF [5]

Just add multicast to a link-state routing protocol thus OSPF  $\Rightarrow$  MOSPF

- Use the multiprotocol facility in OSPF to carry multicast information
- Extended with a group-membership LSA
  - This LSA lists only members of a given group
- Use the resulting link-state database to build delivery trees
  - Compute least-cost **source-based** trees considering metrics using Dijkstra's algorithm
  - A tree is computed for **each (S,G) pair** with a given source (S), this is done for all S
  - Remember that as a link-state routing protocol that every router will know the topology of the complete network
- However, it is expensive to keep store all this information (and most is unnecessary)
  - Cache only the active (S,G) pairs
  - Use a **data-driven** approach, i.e., only computes a new tree when a multicast datagram arrives for this group

# Reverse -Path Forwarding (RPF)

RPF algorithm takes advantage of a routing table to “orientate” the network and to compute an implicit tree per network source.

## Procedure

1. When a multicast packet is received, note source (S) and interface (I)
2. If I belongs to the shortest path toward S, forward to all interfaces except I.
  - Compute shortest path **from** the **source** to the node rather than from the node to the source.
  - Check whether the local router is on the shortest path between a neighbor and the source before forwarding a packet to that neighbor. If this is not the case, then there is no point in forwarding a packet that will be immediately dropped by the next router.

- RPF results in a different spanning tree for each source.

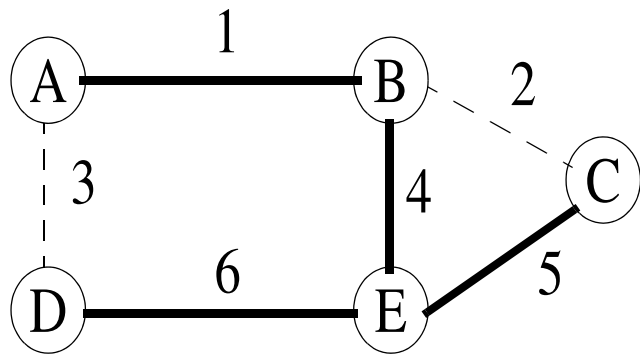

RPF tree from E

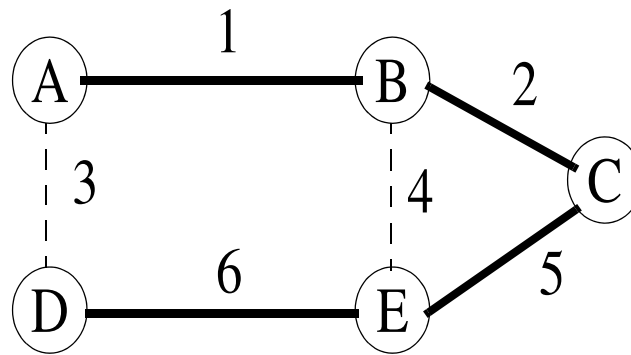

RPF tree from C

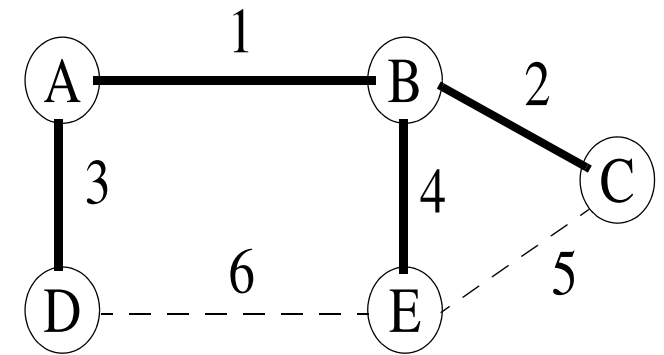

RPF tree from A

These trees have two interesting properties:

- They guarantee the fastest possible delivery, as multicasting follows the shortest path from source to destination
- Better network utilization, since the packets are spread over multiple links.

#### Drawback

- ✗ Group membership is **not** taken into account when building the tree  
 ⇒ a network can receive two or more copies of a multicast packet



# Reverse Path Broadcast (RPB)

- We define a parent router for each network
  - For each source, a router will forward a multicast packet **only** if it is the designated parent
- ⇒ each network gets only one copy of each multicast packet

# RPB + Prunes $\Rightarrow$ Reverse Path Multicast (RPM)

When source S starts a multicast transmission the first packet is propagated to all the network nodes (i.e., **flooding**). Therefore all leaf nodes receive the first multicast packet. However, if there is a leaf node that does **not** want to receive further packets, it will send back a “**prune**” message to the router that sent it this packet - saying effectively “don’t send further packets from source S to group G on this interface I.”

There are two obvious drawback in the flood and prune algorithm:

- The first packet is flooded to the whole network
- The routers must keep states per group and source

When a listener joins at a leaf that was pruned, we add this leaf back by **grafting**.

Flood and prune was acceptable in the experimental MBONE which had only a few tens of thousands of nodes, but for the Internet where both the number of sources and the number of groups becomes very large, there is a risk of exhausting the memory resources in network routers.

# Distance-Vector Multicast Routing Protocol (DVMRP) [6]

- Start with a unicast distance-vector routing protocol (e.g., RIP), then extend (Destination, Cost, Nexthop)  $\Rightarrow$  (Group, Cost, Nexthops)
  - Routers only know their next hop (i.e., which neighbor)
- Reverse Path Multicasting (RPM)
- DVMRP is **data-driven** and uses **source-based** trees

# Multicast Routing - Steiner Tree's

Assume source C and the recipients are A and D.

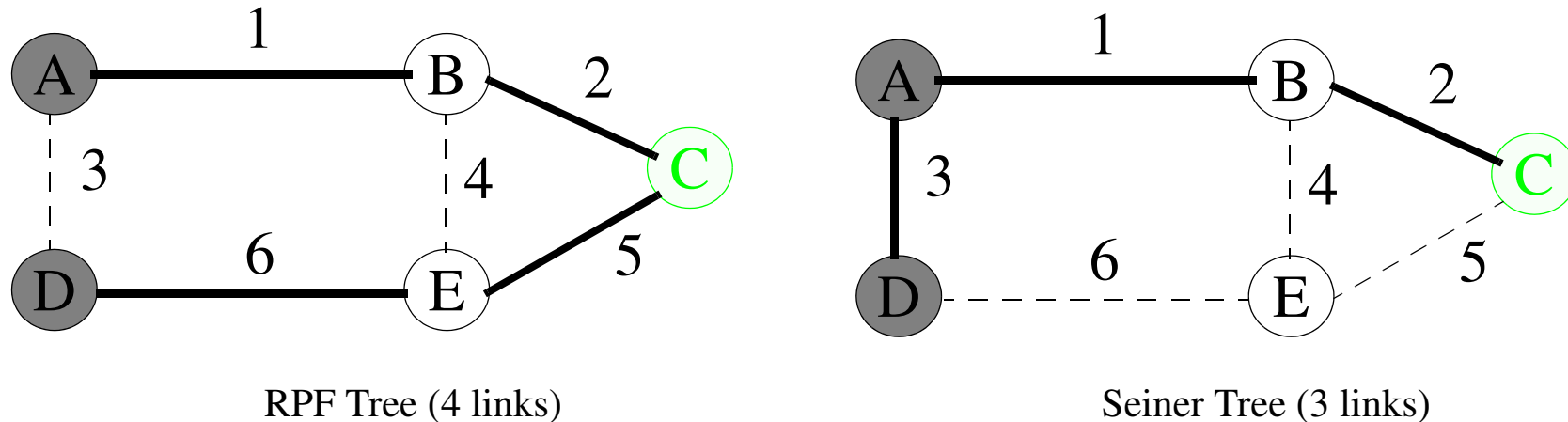

Figure 10: RPF vs. Steiner Tree

- Steiner tree uses less resources (links), but are *very hard* to compute (N-P complete)
- In Steiner trees the routing changes widely if a new member joins the group, this leads to instability. Thus the Steiner tree is more a mathematical construct than a practical tool.

# Core-Based Trees (CBT)

A fixed point in the network chosen to be the center of the multicast group, i.e., “core”. Nodes desiring to be recipients send “join” commands toward this core. These commands will be processed by all intermediate routers, which will mark the interface on which they received the command as belonging to the group’s tree. The routers need to keep one piece of state information per group, listing all the interface that belong to the tree. If the router that receives a join command is already a member of the tree, it will mark only one more interface as belong to the group. If this is the first join command that the router receives, it will forward the command one step further toward the core.

## Advantages

- CBT limits the expansion of multicast transmissions to precisely the set of all recipients (so it is demand-driven). This is in contrast with RPF where the first packet is sent to the whole network.
- The amount of state is less; it depends only on the number of the groups, not the number of pairs of sources and groups  $\Rightarrow$  Group-shared multicast trees  $(*, G)$
- Routing is based on a spanning tree, thus CBT does **not** depend on multicast or unicast routing tables

## Disadvantages

- The path between some sources and some receivers may be suboptimal.
- Senders sends multicast datagrams to the core router encapsulated in unicast datagrams

# Protocol-Independent Multicast (PIM)

Two modes:

- PIM-dense mode (PIM-DM) [8]
  - Dense mode is an implementation of RPF and prune/graft strategy
  - Relies on unicast routing tables providing an optimal path
  - However, it is independent of the underlying unicast protocol
- PIM-sparse mode (PIM-SM) [7]
  - Sparse mode is an implementation of CBT where join points are called “rendezvous points”
  - A given router may know of more than one rendezvous point
  - Simpler than CBT as there is no need for acknowledgement of a join message
  - Can switch from group-shared tree to source-based tree if there is a dense cluster far from the nearest rendezvous point

The adjectives “dense” and “sparse: refer to the **density** of group members in the Internet. Where a group is send to be **dense** if the probability is high that the area contains at least one group member. It is send to be **sparse** if that probability is low.

# Multiprotocol BGP (MBGP) [10]

Extends BGP to enable **multicast routing policy**, thus it connects multicast topologies within and between BGP autonomous systems

Add two new (optional and non-transitive) attributes:

- Multiprotocol Reachable NLRI (MP\_REACH\_NLRI)
- Multiprotocol Unreachable NLRI (MP\_UNREACH\_NLRI)

As these are **optional and non-transitive** attributes - routers which do not support these attributes ignore them and don't pass them on.

Thus MBGP allows the exchange of multicast routing information, but one must still use PIM to build the distribution tree to actually forward the traffic!

# Multicast backbone (MBONE) [2]

Why can you do when all router's and networks don't support multicasting:  
Tunnel!

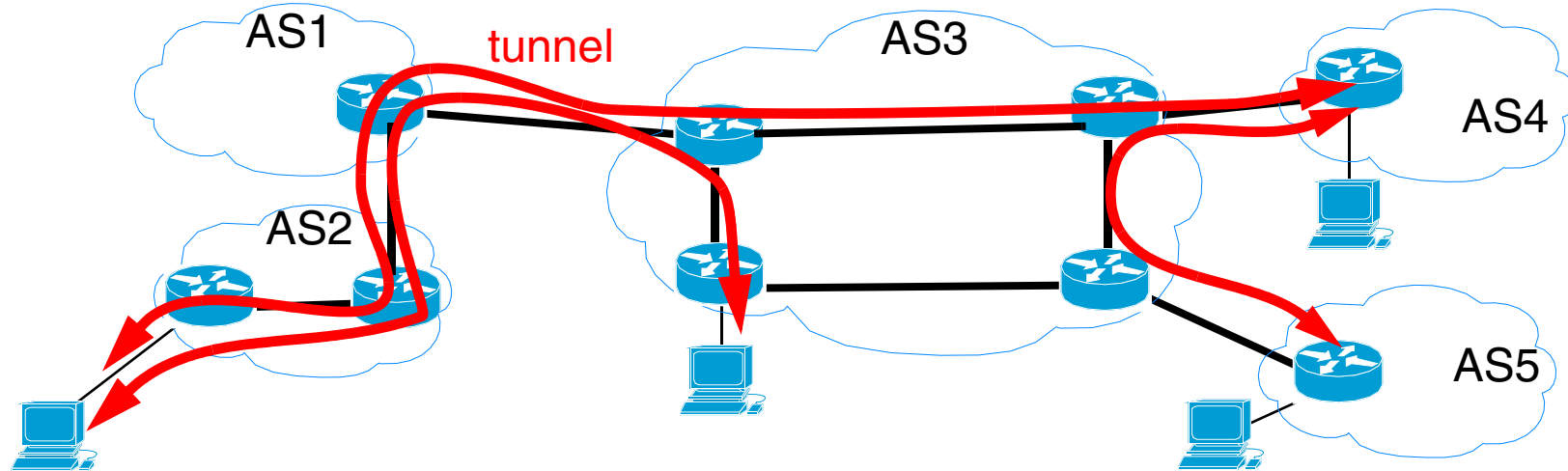

Figure 11: Multicast routing via tunnels - the basis of MBONE (see Forouzan figure 15.14 pg. 453)

See the IETF MBONE Deployment Working Group (MBONED)

<http://antc.uoregon.edu/MBONED/> and their charter <http://www.ietf.org/html.charters/mboned-charter.html>



# Telesys class was multicast over MBONE

Already in Period 2, 1994/1995 "Telesys, gk" was multicast over the internet and to several sites in and near Stockholm.

Established ports for each of the data streams:

- electronic whiteboard
- video stream
- audio stream

The technology works - but it is very important to get the audio packets delivered with modest delay and loss rate. Poor audio quality is perceived a major problem.

NASA and several other organizations regularly multicast their audio and video “programs”.

# Benefits for Conferencing

- IP Multicast is efficient, simple, robust
- Users can join a conference without enumerating (or even knowing) other participants
- User can join and leave at any time
- Dynamic membership

# MBONE Chronology

|            |   |
|------------|---|
| Nov. 1988  | Small group proposes testbed net to DARPA. This becomes DARTNET                       |
| Nov. 1990  | Routers and T1 lines start to work  |
| Feb. 1991  | First packet audio conference (using ISI's vt)  |
| Apr. 1991  | First multicast audio conference  |
| Sept. 1991 | First audio+video conference (hardware codec)   |
| Mar. 1992  | Deering & Casner broadcast San Diego IETF to 32 sites in 4 countries                  |
| Dec. 1992  | Washington DC IETF - four channels of audio and video to 195 watchers in 12 countries |
| Jan. 1993  | MBONE events go from one every 4 months to several a day                              |
| 1994/1995  | Telesys gk -- multicast from KTH/IT in Stockholm                                      |
| July 1995  | KTH/IT uses MBONE to multicast two parallel sessions from IETF meeting in Stockholm   |
| ...        |   |
| today      | lots of users and "multicasters"  |

IETF meetings are *now* regularly multicast - so the number of participants that can attend is not limited by physical space or travel budgets.

# MBONE growth

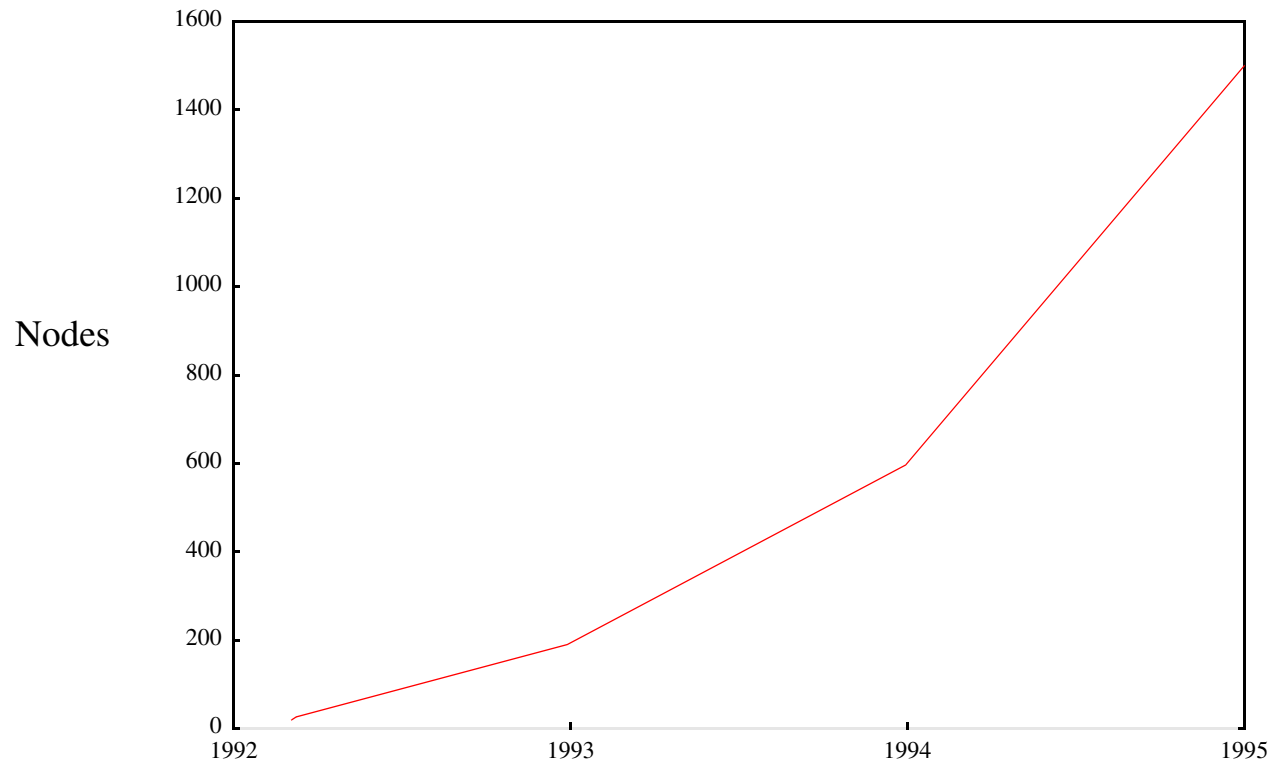

Figure 12: MBONE Growth - Doubling time ~8 months

For the some statistics see: <http://www.caida.org/tools/measurement/mantra/>

|           |                            |   |                |
|-----------|----------------------------|---|----------------|
| Multicast | 2003                       | <b>2002</b>                                     | Old state 2000 |
|           | 02/06/2003,15:25:38<br>PST | 01/21/2002,11:30 PST<br>(Pacific Standard Time) |                |

---

| Entity               | Value |           |     |
|----------------------|-------|-----------|-----|
| #Groups              | 4473  | 1002      | 330 |
| #Participants        | 6059  | average 4 |     |
| #Unique Participants | 1446  |           |     |
| #ASes                | 137   |           |     |
| #RPs                 | 197   |           |     |

But we are still waiting for multicast to “take off”.

# MBONE connections

MBONE is an “overlay” on the Internet

- multicast routers were distinct from normal, unicast routers - but increasingly routers support multicasting
- it is not trivial to get hooked up
- requires cooperation from local and regional people

MBONE is changing:

- Most router vendors now support IP multicast
- MBONE will go away as a distinct entity once ubiquitous multicast is supported throughout the Internet.
- Anyone hooked up to the Internet can participate in conferences

# mrouterd

mrouterd UNIX daemon

tunneling to other MBONE routers

See: “Linux-Mrouterd-MiniHOWTO: How to set up Linux for multicast routing”  
by Bart Trojanowski <bart@jukie.net>, v0.1, 30 October 1999

<http://jukie.net/~bart/multicast/Linux-Mrouterd-MiniHOWTO.html>

and <http://www.linuxdoc.org/HOWTO/Multicast-HOWTO-5.html>

# Multicast Source Discovery Protocol (MSDP)[13]

As the routing protocols deployed in the multicast networks operating in sparse mode do not support flooding information, a mechanism was needed to propagate information about sources (i.e., hosts sourcing data to a multicast group) and the associated multicast groups to all the multicast networks.

Sends Source Active (SA) messages containing (S,G,RP):

- Source Address,
- Group Address,
- and RP Address

these are propagated by Rendezvous Points over TCP

MSDP connects multiple PIM-SM domains together. Each domain uses its own **independent** Rendezvous Point (RP) and does not depend on RPs in other domains.



# GLOP addressing

Traditionally multicast address allocation has been dynamic and done with the help of applications like SDR that use Session Announcement Protocol (SAP).

GLOP is an example of a policy for allocating multicast addresses (it is still experimental in nature). It allocated the 233/8 range of multicast addresses amongst different ASes such that each AS is statically allocated a /24 block of multicast addresses. See [9]



# Single Source Multicast (SSM) [15]

- A single source multicast-address space was allocated to 232/8
- Each AS is allocated a unique 232/24 address block that it can use for multicasting.

# Other multicast efforts

PGM: Pragmatic General Multicast Protocol [14]

Administratively Scoped IP Multicast [16]

...

# Tools for managing multicast

“Managing IP Multicast Traffic” A White Paper from the IP Multicast Initiative (IPMI) and Stardust Forums for the benefit of attendees of the 3rd Annual IP Multicast Summit, February 7-9, 1999

<http://techsup.vcon.com/whtpprs/Managing%20IP%20Multicast%20Traffic.pdf>

|            |  |
|------------|--|
| Mrinfo     | shows the multicast tunnels and routes for a router/mrouted. |
| Mtrace     | traces the multicast path between two hosts.                 |
| RTPmon     | displays receiver loss collected from RTCP messages.         |
| Mhealth    | monitors tree topology and loss statistics.                  |
| Multimon   | monitors multicast traffic on a local area network.          |
| Mlisten    | captures multicast group membership information.             |
| Dr. Watson | collects information about protocol operation.               |

## Mantra (Monitor and Analysis of Traffic in Multicast Routers)

<http://www.caida.org/tools/measurement/mantra/>

# SNMP-based tools and multicast related MIBs

Management Information Bases (MIBs) for multicast:

RTP MIB

designed to be used by either host running RTP applications or intermediate systems acting as RTP monitors; has tables for each type of user; collect statistical data about RTP sessions.

Basic Multicast Routing MIB

includes only general data about multicast routing. such as multicast group and source pairs; next hop routing state, forwarding state for each of a router's interfaces, and information about multicast routing boundaries.

# Protocol-Specific Multicast Routing MIBs

Provide information specific to a particular routing protocol

|            |  |
|------------|--|
| PIM MIB    | list of PIM interfaces that are configured; the router's PIM neighbors; the set of rendezvous points and an association for the multicast address prefixes; the list of groups for which this particular router should advertise itself as the candidate rendezvous point; the reverse path table for active multicast groups; and component table with an entry per domain that the router is connected to. |
| CBT MIB:   | configuration of the router including interface configuration; router statistics for multicast groups; state about the set of group cores, either generated by automatic bootstrapping or by static mappings; and configuration information for border routers.  |
| DVMRP MIB  | interface configuration and statistics; peer router configuration states and statistics; the state of the DVMRP (Distance-Vector Multicast Routing Protocol) routing table; and information about key management for DVMRP routes.   |
| Tunnel MIB | lists tunnels that might be supported by a router or host. The table supports tunnel types including Generic Routing Encapsulation (GRE) tunnels, IP-in-IP tunnels, minimal encapsulation tunnels, layer two tunnels (LTTP), and point-to-point tunnels (PPTP).  |
| IGMP MIB   | only deals with determining if packets should be forwarded over a particular leaf router interface; contains information about the set of router interfaces that are listening for IGMP messages, and a table with information about which interfaces currently have members listening to particular multicast groups.   |

# SNMP tools for working with multicast MIBs

Merit SNMP-Based Management Project has release two freeware tools which work with multicast MIBs:

|       |   |
|-------|---|
| Mstat | queries a router or SNMP-capable mouted to generate various tables of information including routing tables, interface configurations, cache contents, etc.                  |
| Mview | "application for visualizing and managing the MBone",allows user to display and interact with the topology, collect and monitor performance statistics on routers and links |

HP Laboratories researchers investigating IP multicast network management are building a prototype integrated with HP OpenView -- intended for use by the network operators who are not experts in IP multicast; provides discovery, monitoring and fault detection capabilities.

# QoS & Scheduling algorithms

Predictable delay is thought to be required for interactive real-time applications:

Alternatives:

1. use a network which guarantees fixed delays
2. use a packet scheduling algorithm
3. retime traffic at destination

Since queueing at routers, hosts, etc. has traditionally been simply FIFO; which does not provide guaranteed end-to-end delay both the 2nd and 3rd method use alternative algorithms to maintain a predictable delay.

Algorithms such as: Weighted Fair Queueing (WFQ)

These algorithms normally emulate a fluid flow model.

As it is very hard to provide fixed delays in a network, hence we will examine the 2nd and 3rd methods.



# RSVP: Resource Reservation Setup Protocol [19]

- RSVP is a network control protocol that will deal with resource reservations for certain Internet applications.
- RSVP is a component of “Integrated services” Internet, and can provide both best-effort and QoS.
  - Applications request a specific quality of service for a data stream
- RSVP delivers QoS requests to each router along the path.
  - Maintains router and host state along the data stream during the requested service.
  - Hosts and routers deliver these request along the path(s) of the data stream
  - At each node along the path RSVP passes a new resource reservation request to an admission control routine

RSVP is a signalling protocol carrying no application data

- First a host sends IGMP messages to join a group
- Second a host invokes RSVP to reserve QoS

# Functionality

- RSVP is receiver oriented protocol.  
The receiver is responsible for requesting reservations.
- RSVP handles heterogeneous receivers.  
Hosts in the same multicast tree may have different capabilities and hence need different QoS.
- RSVP adapts to changing group membership and changing routes.  
RSVP maintains “Soft state” in routers. The only permanent state is in the end systems. Each end system sends their RSVP control messages to refresh the router state.  
In the absence of refresh message, RSVP state in the routers will time-out and be deleted.
- RSVP is **not** a routing protocol.  
A host sends IGMP messages to join a multicast group, but it uses RSVP to reserve resources along the delivery path(s) from that group.

# Resource Reservation

- Interarrival variance reduction / jitter
- Capacity assignment / admission control
- Resource allocation (who gets the bandwidth?)

# Jitter Control

- if network has enough capacity  
average departure rate = receiver arrival rate
- Then jitter is caused by queue waits due to competing traffic
- Queue waits should be at most the amount of competing traffic in transit, total amount of in transit data should be at most round trip propagation time  
(100 ms for transcontinental path)  
(64 kbit/sec => buffer = 8 kb/s\*0.1 sec = 800 bytes)

See: Jonathan Rosenberg, Lili Qiu, and Henning Schulzrinne, “Integrating Packet FEC into Adaptive Voice Playout Buffer Algorithms on the Internet”, INFOCOM, (3), 2000, pp. 1705-1714.

See also <http://citeseer.nj.nec.com/rosenberg00integrating.html>

# Capacity Assignment

- end-nodes ask network for bandwidth.
- Can get “yes” or “no” (busy signal)
- Used to control available transmission capacity

# RSVP Protocol Mechanism

- Sender sends RSVP PATH message which records path
- Receiver sends RSVP RESV message backwards along the path indicating desired QoS
- In case of failure a RSVP error message is returned



Figure 13:

# RSVP Soft State

- “soft state” in hosts and routers
- create by PATH and RESV messages
- refreshed by PATH and RESV messages
- Time-outs clean up reservations
- Removed by explicit “tear-down” messages

# RSVP operation

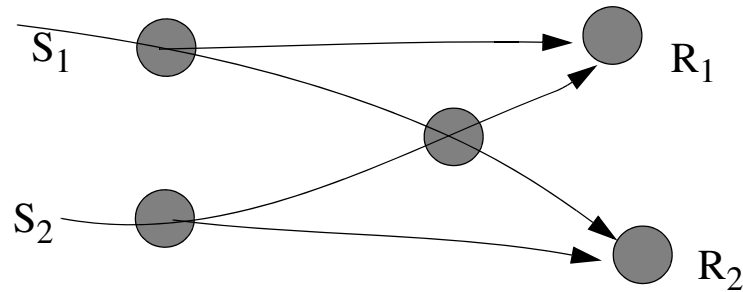

Figure 14:

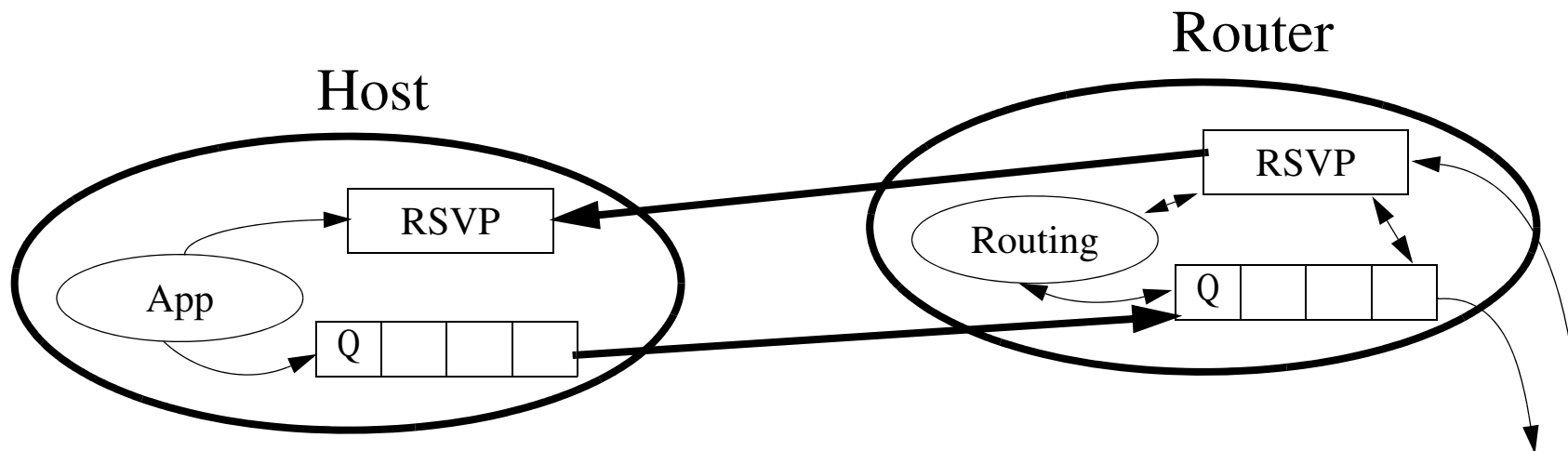

Figure 15:



# RSVP operations (continued)

- At each node, RSVP applies a local decision procedure “admission control” to the QoS request. If the admission control succeeds, it set the parameters to the classifier and the packet scheduler to obtain the desired QoS. If admission control fails at any node, RSVP returns an error indication to the application.
- Each router in the path capable of resource reservation will pass incoming data packets to a packet classifier and then queue these packet in the packet scheduler. The packet classifier determines the route and the QoS class for each packet. The scheduler allocates a particular outgoing link for packet transmission.
- The packet scheduler is responsible for negotiation with the link layer to obtain the QoS requested by RSVP. The scheduler may also negotiate a “CPU time”.

# RSVP Summary

- RSVP supports multicast and unicast data delivery
- RSVP adapts to changing group membership and routes
- RSVP reserves resources for simplex data streams
- RSVP is receiver oriented, i.e., the receiver is responsible for the initiation and maintenance of a flow
- RSVP maintains a “soft-state” in routers, enabling them to support gracefully dynamic memberships and automatically adapt to routing changes
- RSVP provides several reservation models
- RSVP is transparent for routers that do not provide it

# Argument against Reservation

Given, the US has 126 million phones:

- Each conversation uses 64 kbit/sec per phone
- Therefore the total demand is:  $8 \times 10^{12}$  b/s (1 Tbyte/s)

One optical fiber has a bandwidth of  $\sim 25 \times 10^{12}$  b /s

There are well over 1000 transcontinental fibers!

Why should bandwidth be a problem?

# Further reading

IETF *Routing Area*, especially:

- Inter-Domain Multicast Routing (*idmr*)
- Multicast Extensions to OSPF (*mospf*)

IETF *Transport Area* especially:

- Differentiated Services (*diffserv*)
- RSVP Admission Policy (*rap*)
- Multicast-Address Allocation (*malloc*)

With lots of traditional broadcasters and others discovering multicast -- it is going to be an exciting area for the next few years.

# Summary

This lecture we have discussed:

- Multicast, IGMP, RSVP

# References

- [1] Joe Abley, f.root-servers.net, NZNOG 2005, February 2005, Hamilton, NZ  
<http://www.isc.org/pubs/pres/NZNOG/2005/F%20Root%20Server.pdf>
- [2] S. Deering, “Host Extensions for IP Multicasting”, IETF RFC 1112, August 1989 <http://www.ietf.org/rfc/rfc1112.txt>
- [3] W. Fenner, “Internet Group Management Protocol, Version 2”, IETF RFC 2236 , November 1997  
<http://www.ietf.org/rfc/rfc2236.txt>
- [4] B. Cain, S. Deering, I. Kouvelas, B. Fenner, and A. Thyagarajan, “Internet Group Management Protocol, Version 3”, IETF RFC 3376, October 2002 <http://www.ietf.org/rfc/rfc3376.txt>
- [5] J. Moy, “Multicast Extensions to OSPF”, IETF RFC 1584, March 1994 <http://www.ietf.org/rfc/rfc1584.txt>
- [6] D. Waitzman, C. Partridge, and S. Deering, “Distance Vector Multicast Routing Protocol”, IETF RFC 1075 , November 1988  
<http://www.ietf.org/rfc/rfc1075.txt>
- [7] D. Estrin, D. Farinacci, A. Helmy, D. Thaler, S. Deering, M. Handley, V. Jacobson, C. Liu, P. Sharma, and L. Wei, “Protocol Independent Multicast-Sparse Mode (PIM-SM): Protocol Specification”, IETF RFC 2362, June 1998  
<http://www.ietf.org/rfc/rfc2362.txt>
- [8] A. Adams, J. Nicholas, and W. Siadak, “Protocol Independent Multicast - Dense Mode (PIM-DM): Protocol Specification (Revised)”, IETF RFC 3973, January 2005 <http://www.ietf.org/rfc/rfc3973.txt>
- [9] D. Meyer and P. Lothberg, “GLOP Addressing in 233/8”, IETF RFC 3180 September 2001  
<http://www.ietf.org/rfc/rfc3180.txt>
- [10] T. Bates, Y. Rekhter, R. Chandra, and D. Katz, “Multiprotocol Extensions for BGP-4”, IETF RFC 2858, June 2000  
<http://www.ietf.org/rfc/rfc2858.txt>
- [11] Beau Williamson, *Developing IP Multicast Networks*, Cisco Press, 2000
- [12] Internet Protocol Multicast, Cisco, Wed Feb 20 21:50:09 PST 2002  
[http://www.cisco.com/univercd/cc/td/doc/cisintwk/ito\\_doc/ipmulti.htm](http://www.cisco.com/univercd/cc/td/doc/cisintwk/ito_doc/ipmulti.htm)

- [13] B. Fenner and D. Meyer (Editors), “Multicast Source Discovery Protocol (MSDP)”, IETF RFC 3618, October 2003  
<http://www.ietf.org/rfc/rfc3618.txt>
- [14] T. Speakman, J. Crowcroft, J. Gemmell, D. Farinacci, S. Lin, D. Leshchiner, M. Luby, T. Montgomery, L. Rizzo, A. Tweedly, N. Bhaskar, R. Edmonstone, R. Sumanasekera and L. Vicisano, “PGM Reliable Transport Protocol Specification”, IETF RFC 3208 , December 2001
- [15] S. Bhattacharyya (Ed.), “An Overview of Source-Specific Multicast (SSM)”, IETF RFC 3569, July 2003  
<http://www.ietf.org/rfc/rfc3569.txt>
- [16] D. Meyer, “Administratively Scoped IP Multicast”, IETF RFC 2365, July 1998 <http://www.ietf.org/rfc/rfc2365.txt>
- [17] B. Quinn and K. Almeroth, “IP Multicast Applications: Challenges and Solutions”, IETF RFC 3170, September 2001  
<http://www.ietf.org/rfc/rfc3170.txt>
- [18] R. Braden (Ed.), L. Zhang, S. Berson, S. Herzog, and S. Jamin, “Resource ReSerVation Protocol (RSVP) -- Version 1 Functional Specification”, IETF RFC 2205, September 1997 <http://www.ietf.org/rfc/rfc2205.txt>
- [19] Y. Snir, Y. Ramberg, J. Strassner, R. Cohen, and B. Moore, “Policy Quality of Service (QoS) Information Model”, IETF RFC 3644, November 2003 <http://www.ietf.org/rfc/rfc3644.txt>

# IK1550 Internetworking/Internetteknik

## Spring 2010, Period 4

### Module 9: Applications: Network Management and VoIP

Lecture notes of G. Q. Maguire Jr.



KTH Information and  
Communication Technology

© 2010 G.Q.Maguire Jr. .

All rights reserved. No part of this course may be reproduced, stored in a retrieval system, or transmitted, in any form or by any means, electronic, mechanical, photocopying, recording, or otherwise, without written permission of the author.

Last modified: 2010.03.21:17:35



# Lecture 5: Outline

- Network Management
- SNMP
- VoIP
- Twitter

# ISO FCAPS Network Management Model

- **F**ault management
- **C**onfiguration management
- **A**ccounting management
- **P**erformance management
- **S**ecurity management

# Network Management Process

## Network Management System (NMS)

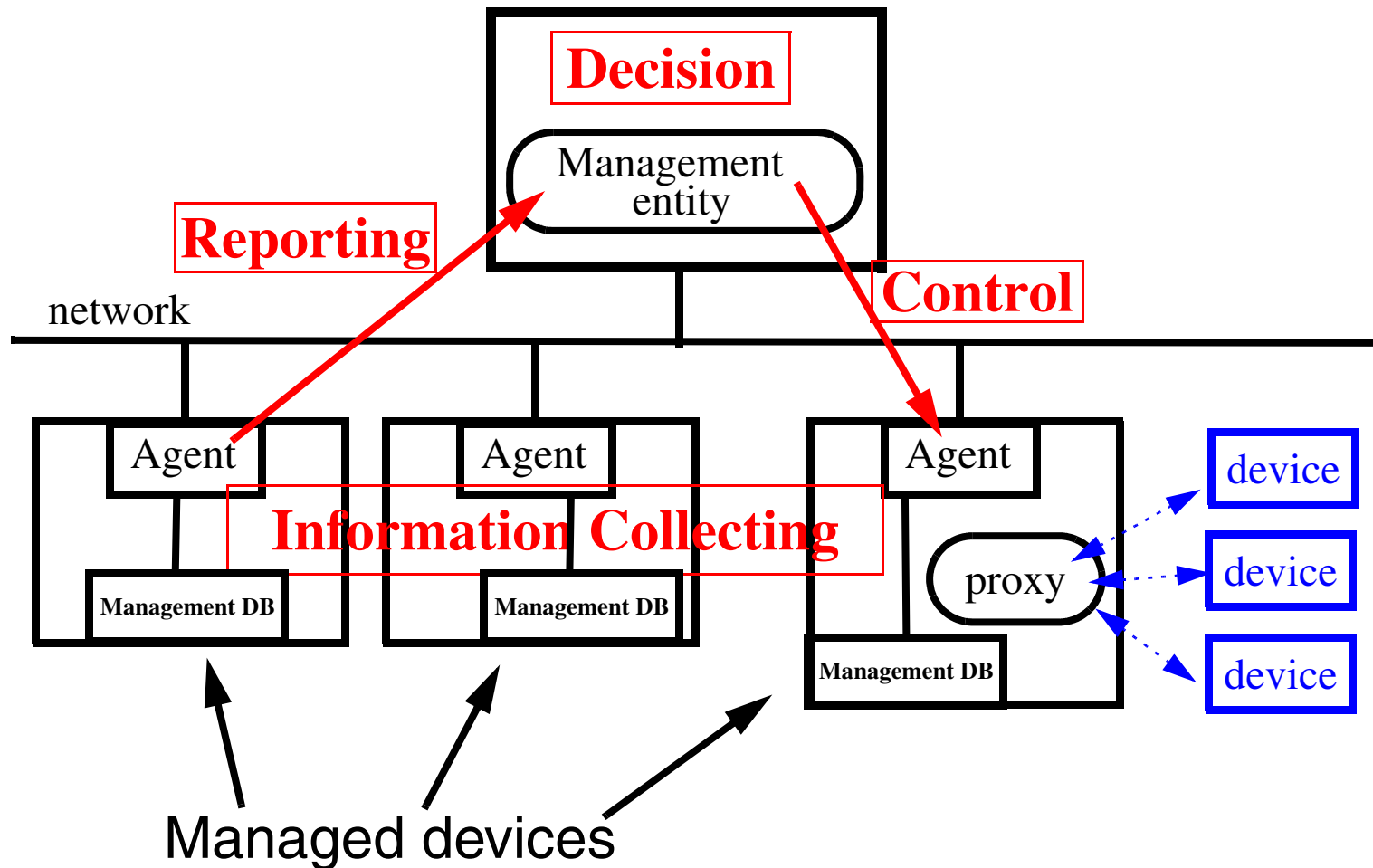

# Network Management Process

Simple Network Management Protocol (SNMP), Management Information Base (MIB), Structure of Management Information (SMI)

## Network Management System (NMS)

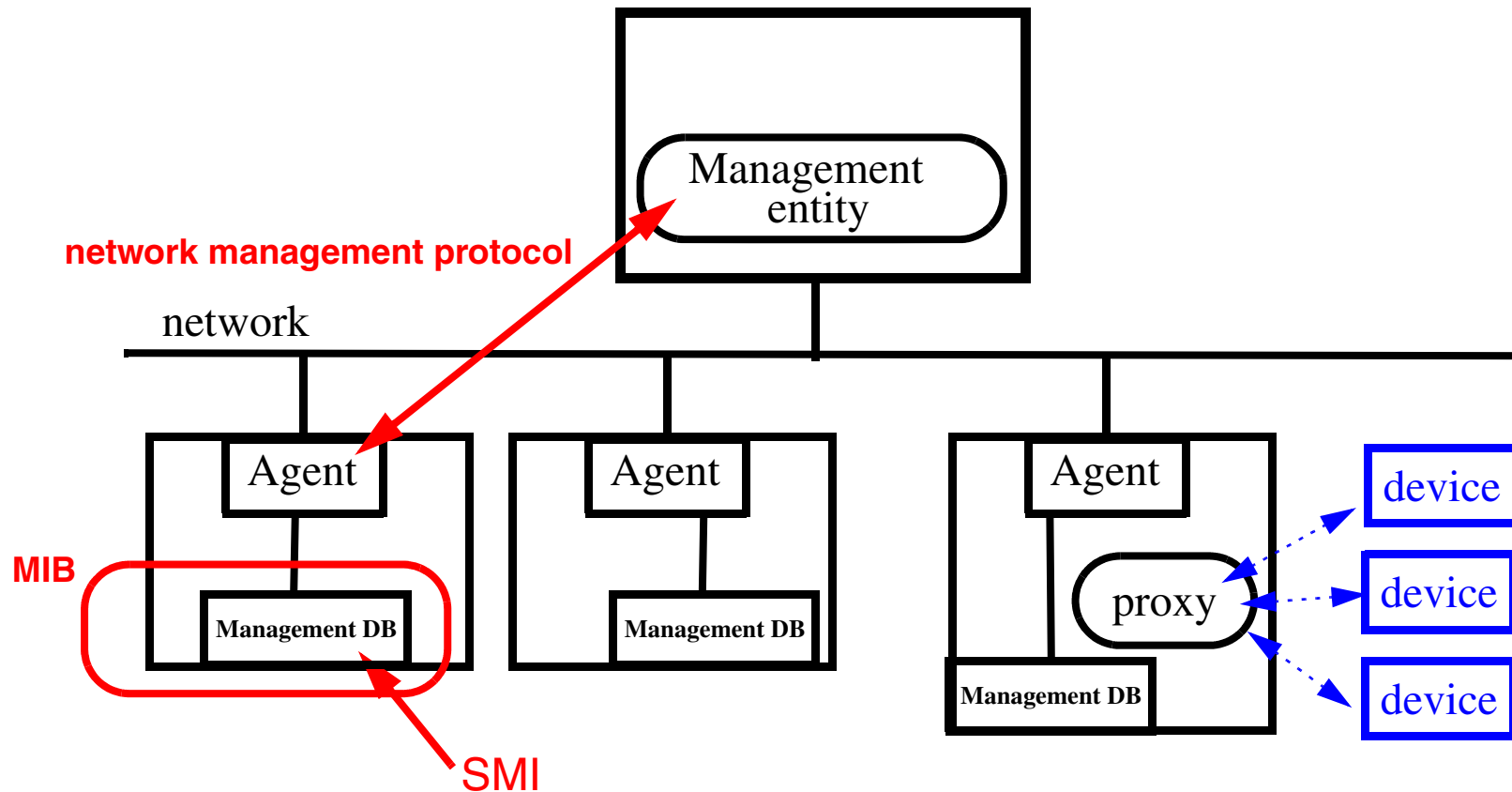

# SNMP

Version 1

Version 2 - in 1992-1993, the SNMPv2 Working Group developed a security model based on parties to an SNMP transaction - this was known as SNMPv2p. But the working group decided that a user-based security model was much simpler - and hence more likely to be deployed.

December 1995, the SNMPv2 Working Group was deactivated, but two prominent approaches emerged from independent groups:

|         |   |
|---------|---|
| SNMPv2u | early standardization of the security features and a minimal specification - to encourage rapid deployment of simple agents;<br><br>deferred standardization of features for managing large networks  |
| SNMPv2* | concurrent standardization of <b>security</b> and <b>scalability</b> features to ensure that the security design addressed issues of: proxy, trap destinations, discovery, and remote configuration of security<br><br>Focus was effective management of medium and large networks. |

August 1996 a team was formed to recommend a single approach.

# SNMPv3

March 1997, the SNMPv3 Working group was chartered to define a standard for SNMP security and administration. Target: April 1998 - all SNMPv3 specifications submitted to IESG for consideration as Proposed Standards.

Based on “An Architecture for Describing SNMP Management Frameworks” (RFC 2271)

Composed of multiple subsystems:

1. a message processing and control subsystem - Message Processing and Dispatching for SNMP (RFC 2272)
2. a security subsystem - based on a User-based Security Model (USM) (RFC 2274), provides SNMP message level security (Keyed-MD5 as the authentication protocol and the use of CBC-DES as the privacy protocol - but with support for others) defines a MIB for remotely monitoring/managing the configuration parameters for this Security model
3. a local processing subsystem - responsible for processing the SNMP PDUs that operate on local instrumentation, applies access control [View-based Access Control Model (VACM) (RFC 2275)] and invokes method routines to access management information, and prepares a response to the received SNMP request.
4. SNMPv3 Applications (RFC 2273) - includes Proxy Forwarder Applications, which can forward SNMP requests to other SNMP entities, to translate SNMP requests of one version into SNMP requests of another version or into operations of some non-SNMP management protocol; and support aggregated managed objects where the value of one managed object depends upon the values of multiple (remote) items.

# SNMP

- SNMPv1
  - only 5 commands: [get-request](#), [get-next request](#), [set-request](#), [response](#)
  - Clear-text password
- SNMPv2: 1992-1996
  - [get-bulk-request](#)
  - [inform-request](#) (for proxy)
  - [trap](#)
  - v2 MIB and M2M MIB
  - Authentication
- SNMPv3: 1997-
  - more security enhancement
  - View-based access control - so different managers can see different subset of the information
  - remote configuration

# Management Information Base: MIB

MIB is the database of information maintained by the agent that the manager can query or set.

It specifies the data items a managed device must keep, the operations allowed on each item.

See RFC 1213 “Management Information Base for Network Management of TCP/IP-based internets: MIB-II” <http://www.ietf.org/rfc/rfc1213.txt>

See also:

- RFC 2011: SNMPv2 Management Information Base for the Internet Protocol using SMIv2.
- RFC 2012: SNMPv2 Management Information Base for the Transmission Control Protocol using SMIv2.
- RFC 2013: SNMPv2 Management Information Base for the User Datagram Protocol using SMIv2.



# Case Diagram

To understand the relationship between counters and to make sure that all the data paths for a packet are accounted for.

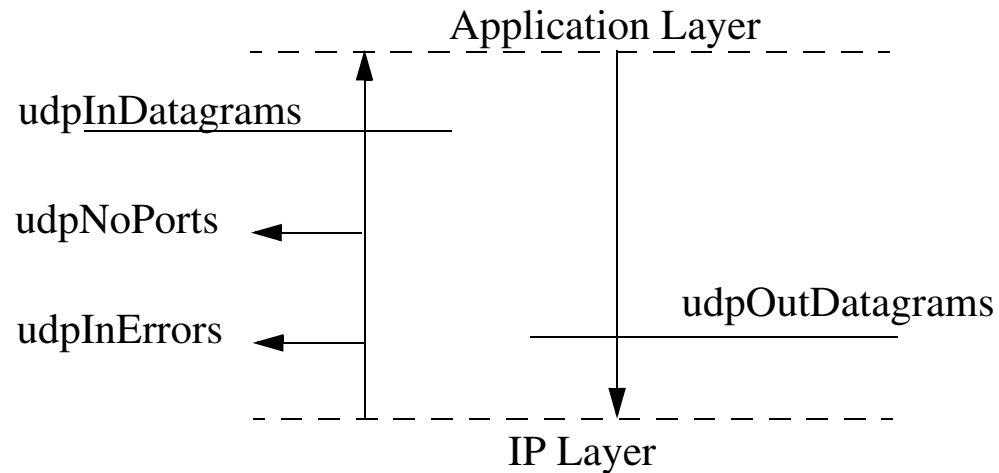

Figure 1: Case diagram of UDP group (W. R. Stevens, TCP/IP Illustrated, V.1, pg. 367)

# SNMP Traps

Agent sends a trap to manager to indicate that something has happened.

Following trap types are defined:

- 0: coldStart
- 1: warmStart
- 2: linkDown
- 3: linkUP
- 4: authenticationFailure
- 5: egpNeighborLoss
- 6: enterpriseSpecific

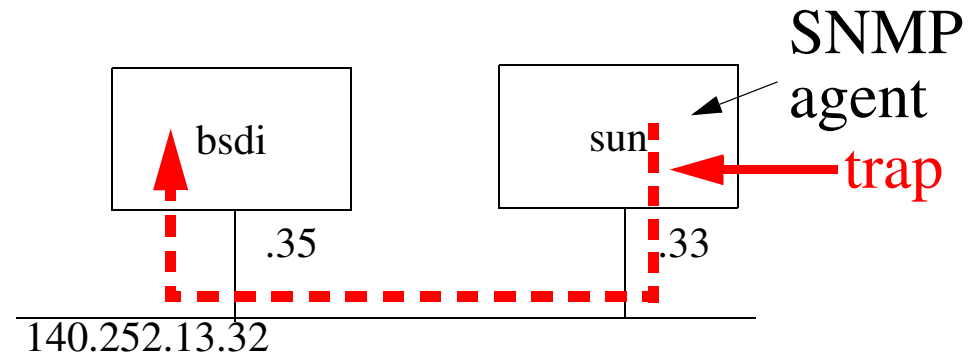

Example: start the SNMP agent on sun and send traps to bsdi; tcpdump output:

```

1 0.0      sun.snmp > bsdi.snmp-trap: C=traps Trap(28)
E:unix.1.2.5 [140.252.13.33] coldstart 20
2 18.86    (18.86) sun.snmp > bsdi.snmp-trap: C=traps Trap(29)
E:unix.1.2.5 [140.252.13.33] authenticationFailure 1907
Enterprise: sysObjectID

```

Annotations for the tcpdump output:

- Port 162: Points to the source port of the first trap.
- Port 161: Points to the destination port of the first trap.
- trap type: Points to the trap type 'coldstart' in the first trap.
- PDU type (length): Points to 'Trap(28)' in the first trap.
- timestamp: Points to the time '20' in the first trap.
- Enterprise: sysObjectID: Points to 'unix.1.2.5' in the first trap.
- IP address of agent: Points to '140.252.13.33' in the first trap.

# Remote MONitoring (RMON)

[ *RMON MIB 1 (RFC1757)*, *RMON MIB 2 (RFC 2021)*, *RMON MIB Protocol Identifiers (RFC 2074)*, *MIB II (RFC1213)* ]

Standard way for users to **proactively** manage multiple LANs from a central site.

## RMON 1

- Notify manager of errors
- provide alerts for network problems
- collects statistical baseline data (i.e., what is “normal” on this LAN), and
- acts as a remote network analyser.

## RMON 2

- access higher level protocol information,
- Point-to-point traffic statistics broken down by higher layer protocols,
- eases trouble-shooting, and
- enables network **capacity planning** [and **to solve problems before they become problems**].

# RMON Probes or Monitors

Network monitoring devices (monitor or probes) are instruments that exist for the purpose of managing a network. Essentially a LAN analyzer - which is always connected to the segment.

- A physical device which is attached to a segment of the network (it will promiscuously listen to traffic - to collect statistics and if requested packets)
- Generally a microprocessor based system with 8<sup>+</sup>MBytes of memory.
- Fairly powerful processors so that events and alarms are not missed.
- In-band or out-of-band communication
  - In-band - you communicate via the probe via the segment it is monitoring
  - Out-of-band - you communicate with it via another path, e.g., a PPP/SLIP/serial connection
- Probes can operate off-line, i.e., they operate even though they may not be in contact with the network management system.

Probes are sold by lots of vendors.

# RMON1 Statistics

## Information collected by examining MAC layer

|                |   | Group      | Description  |
|----------------|---|------------|--|
| Tables         | 1 | Statistics | Statistics for the segment to which the RMON probe is attached                             |
|                | 2 | History    | History (Baselines) of the segment   |
|                | 4 | Host       | Per host statistics for each individual transmitting and receiving device.                 |
|                | 5 | Host Top N | Top N reports on base statistics.  |
|                | 6 | Matrix     | Statistics on all conversations (i.e., who talks to whom)                                  |
| Packet Capture | 7 | Filter     | Match on any part of a frame, including errors (CRC, overruns, etc.)                       |
|                | 8 | Capture    | Collect packets, based on filters, for later retrieval (as if you were a network analyzer) |
| SNMP traps     | 3 | Alarm      | Alarms to monitor for user-defined events.   |
|                | 9 | Event      | Log file for use in conjunction with the Alarm or Filter Group.                            |
| Token rings    |   | Token Ring | Ring Station Order, Ring Configuration and Source Routing Information.                     |

Defined by [RFC 1757](#).

# Ethernet Statistics Group

“These statistics take the form of free running counters that start from zero when a valid entry is created. Each etherStatsEntry contains statistics for one Ethernet interface. The probe must create one etherStats entry for each monitored Ethernet interface on the device.” - from RFC1757

etherStatsTable OBJECT-TYPE

SYNTAX SEQUENCE OF EtherStatsEntry ... ::= { statistics 1 }

etherStatsEntry OBJECT-TYPE

DESCRIPTION

"A collection of statistics kept for a particular Ethernet interface. As an example, an instance of the etherStatsPkts object might be named etherStatsPkts.1"

INDEX { etherStatsIndex } ::= { etherStatsTable 1 }

# EtherStatsEntry

EtherStatsEntry ::= SEQUENCE {

|                                |                     |
|--------------------------------|---------------------|
| etherStatsIndex                | INTEGER (1..65535), |
| etherStatsDataSource           | OBJECT IDENTIFIER,  |
| etherStatsDropEvents           | Counter,            |
| etherStatsOctets               | Counter,            |
| etherStatsPkts                 | Counter,            |
| etherStatsBroadcastPkts        | Counter,            |
| etherStatsMulticastPkts        | Counter,            |
| etherStatsCRCAlignErrors       | Counter,            |
| etherStatsUndersizePkts        | Counter,            |
| etherStatsOversizePkts         | Counter,            |
| etherStatsFragments            | Counter,            |
| etherStatsJabbers              | Counter,            |
| etherStatsCollisions           | Counter,            |
| etherStatsPkts64Octets         | Counter,            |
| etherStatsPkts65to127Octets    | Counter,            |
| etherStatsPkts128to255Octets   | Counter,            |
| etherStatsPkts256to511Octets   | Counter,            |
| etherStatsPkts512to1023Octets  | Counter,            |
| etherStatsPkts1024to1518Octets | Counter,            |
| etherStatsOwner                | OwnerString,        |
| etherStatsStatus               | EntryStatus         |

}

# EtherHistoryEntry

EtherHistoryEntry ::= SEQUENCE {

|                            |                          |
|----------------------------|--------------------------|
| etherHistoryIndex          | INTEGER (1..65535),      |
| etherHistorySampleIndex    | INTEGER (1..2147483647), |
| etherHistoryIntervalStart  | TimeTicks,               |
| etherHistoryDropEvents     | Counter,                 |
| etherHistoryOctets         | Counter,                 |
| etherHistoryPkts           | Counter,                 |
| etherHistoryBroadcastPkts  | Counter,                 |
| etherHistoryMulticastPkts  | Counter,                 |
| etherHistoryCRCAlignErrors | Counter,                 |
| etherHistoryUndersizePkts  | Counter,                 |
| etherHistoryOversizePkts   | Counter,                 |
| etherHistoryFragments      | Counter,                 |
| etherHistoryJabbers        | Counter,                 |
| etherHistoryCollisions     | Counter,                 |
| etherHistoryUtilization    | INTEGER (0..10000)       |

}



# HostEntry

HostEntry ::= SEQUENCE {

|                      |                     |
|----------------------|---------------------|
| hostAddress          | OCTET STRING,       |
| hostCreationOrder    | INTEGER (1..65535), |
| hostIndex            | INTEGER (1..65535), |
| hostInPkts           | Counter,            |
| hostOutPkts          | Counter,            |
| hostInOctets         | Counter,            |
| hostOutOctets        | Counter,            |
| hostOutErrors        | Counter,            |
| hostOutBroadcastPkts | Counter,            |
| hostOutMulticastPkts | Counter             |

}

# Host Top N group

Used to prepare reports that describe the hosts that top a list **ordered** by one of their statistics.

hostTopNControlTable is used to initiate the generation of such a report, the management station selects the parameters, such as:

- which interface,
- which statistic,
- how many hosts, and
- the start and stop times of the sampling.

# The Matrix Group

Matrix group consists of the matrixControlTable, matrixSDTable and the matrixDSTable.

These tables store statistics for a particular conversation between two addresses.

The matrixSDTable - contains a entries indexed by source and destination.

MatrixSDEntry ::= SEQUENCE {

matrixSDSourceAddress   OCTET STRING,

matrixSDDestAddress    OCTET STRING,

matrixSDIndex         INTEGER (1..65535),

matrixSDPkts           Counter,

matrixSDOctets         Counter,

matrixSDErrors         Counter

}

The matrixDSTable - a similar set of statistics (MatrixDSEntry) indexed by destination and source.

# RMON2

Information collected from network and higher layer (“application”) headers  
(defined by [RFC2021](#))

|               |    | Group                          | Description   |
|---------------|----|--------------------------------|---|
| Protocols     | 11 | Protocol Directory             | List of protocol types the probe is capable of monitoring               |
|               | 12 | Protocol Distribution          | Number of packets and octets by protocols on a network segment          |
| Network layer | 13 | Address Mapping                | MAC addresses and corresponding network addresses                       |
|               | 14 | Network Layer Host             | Amount of traffic sent to and from each network address                 |
|               | 15 | Network Layer Matrix           | Amount of traffic between each pair of network addresses                |
|               |    | Network Layer Matrix Top N     | Top N conversations over a user-defined period (packet or octet counts) |
| Higher layers | 16 | Application Layer Host         | Amount of traffic, by protocol  |
|               | 17 | Application Layer Matrix       | Amount of traffic, by Protocol, between each pair of network addresses. |
|               |    | Application Layer Matrix Top N | Top N conversations over a user-defined period (packet or octet counts) |

# Information collected from network and higher layer (“application”) headers (defined by *RFC2021*)

|                 | <b>Group</b> | <b>Description</b>  |   |
|-----------------|--------------|---------------------|---|
|                 | 18           | User History        | Users created custom History Tables based on supported OID's. |
| Probe<br>itself | 19           | Probe Configuration | Configuration of various operating parameters of the probe    |
|                 | 20           | RMON Conformance    | Lists which groups and instances of a group a probe supports  |

# Proprietary MIBs to extend RMON functions

ION Network, Inc. adds:

| Group                    | Description  |
|--------------------------|--|
| FDDI                     | FDDI MAC level and User Data Statistics for FDDI networks  |
| Protocol                 | Bandwidth utilization by protocols   |
| SolCom Host              | Tracks MAC to IP address mappings; including when a host was first and last seen, when a new host appears on the segment |
| Traffic Generation       | Generate traffic using user-defined packets (including packet with errors)   |
| Response Time Monitoring | Works out response times and helps to pin-point WAN failures using ICMP echo-requests initiated from the central site.   |

# Network Management Systems

- HP OpenView -- <http://www.managementsoftware.hp.com/marketsegments/enterprises/index.asp>
  - Derived from OpenView: IBM NetView, Digital Polycenter NetView, and NCR OneVision
- SunSoft Solstice: Site Manager, Solstice Domain Manager, and Enterprise Manager -- <http://www.sun.com/solstice/index.html>
- Aprisma Management Technologies' Spectrum <http://www.aprisma.com/>

# WEB based Management

Using the Web as an interface

- Web based Reporting/Statistics

- Netscount <http://www.netscout.com/>
- HP [Netmetrix](#) WebReporter
- Network Statistics Collection And Reporting Facility (Netscarf <http://www.merit.edu/internet/net-research/netscarf/index.html>), their Scion package consists of five components:
  - scolect - collects network data from a set of routers
  - scook - preprocesses network data into a more convenient (condensed) form
  - scserver - delivers the network data in response to client requests
  - scclient - requests network data from the scserver on behalf of a reporting or graphing application
  - Real-Time Data (rtdata) tree - a flat-file database: stores the data collected by scolect
- Merit Internet Performance and Analysis Project ([IPMA](#)), tools: NetNow, AS Explorer, Route Flap, Routing Table Statistics Generator, ...
  - See also pointers to tools developed by [others](#).

- Web based Interfaced Management Platforms

- [OpenView World Wide Web Interface](#)
- [DR-Web Manager](#) and Agent
- [SiteScope v2.2](#) - a Java-based Web Site Monitoring and Administration Software



- Web based Interfaced Management Tools
  - Cisco *ClickStart* - for configuring a Router with a Web Browser
  - Axis Communications AB's *Thin Server*
- Management of Web Services
  - Harrie Hazewinkel, Carl W. Kalbfleisch, Juergen Schoenwaelder, "Definitions of Managed Objects for WWW Services", November 11, 1997 <http://ietf.org/ids.by.wg/applmib.html>
    - Service Information Group
    - Protocol Statistics Group
    - Document Statistics Group

# Web Based Enterprise Management Initiative (WBEM)

See <http://www.dmtf.org/wbem>

Goal: to consolidate and unify the data provided by **existing** management technologies - in order to solve enterprise problems; i.e., from the application layer problem report down to the interface card - even if the card is in a remote branch office.

Builds on: Intel's Wired for Management (WfM) effort ==> Distributed Management Task Force (formerly Desktop Management Task Force) and Desktop Management Interface (now DMI 2.0)

The DMI was designed to be:

- “independent of a specific computer or operating system
- independent of a specific management protocol
- easy for vendors to adopt
- usable locally -- no network required
- usable remotely using DCE/RPC, ONC/RPC, or TI/RPC
- mappable to existing management protocols (e.g., CMIP, SNMP)
- The DMI procedural interfaces are specifically designed to be remotely accessible through the use of Remote Procedure Calls. The RPCs supported by the DMI include: DCE/RPC, ONC/RPC, and TI/RPC.” -- DMI 2.0 Introduction

## DMI 2.0 has three groups:

- ComponentID group - required for all DMI components, includes information such as the six named attributes: "Manufacturer", "Product", "Version", "Serial Number", "Installation", and "Verify" [asking for this last group causes the device to check itself].
- Event Groups
  - includes a template group used to describe the format of event data for standard events
  - Event State group is defined to hold the current state of state-based events
  - Events can be of different severity levels: Monitor, Information, OK, Non-Critical, Critical, and Non-Recoverable.
- DMI Service Provider Groups - provides the means for those interested in specific events to subscribe to just the events that they want; subscribers can say how they want to be notified (DCE RPC, TI RPC, ONC RPC), what transport protocol should be used (TCP/IP, IPX, ...), when they no longer want to be notified (Subscription Expiration DateStamp), ...

# Four Elements of DMI

- a format for describing management information - Management Information Format (MIF)
  - a language for describing each component;
  - each component has a MIF file to describe its manageable characteristics; and
  - When a component is initially installed into the system, the MIF is added to the (implementation-dependent) MIF database.
- a service provider entity
- two sets of APIs, one set for service providers and management applications to interact (Service Provider API for Components), and the other for service providers and components to interact (Component Provider API), and
- set of services for facilitating remote communication.

# Common Information Model (CIM)

- DMTF Common Information Model (CIM)  
*[http://www.dmtf.org/standards/standard\\_wbem.php](http://www.dmtf.org/standards/standard_wbem.php)* based on object-oriented technologies for use in Web-based management
- XML Mapping Specification v2.0.0
- XML Document Type Definition v2.0.0
- CIM Operations over HTTP, V1.0

# Java and Management

Java Management API (JMAPI) - Set of extensible objects and methods, defines an application programming interfaces (API) which includes:

- JavaManagement API User Interface Style Guide
- Admin View Module (AVM)
- Base Object Interfaces
- Managed Container Interfaces
- Managed Notification Interfaces
- Managed Data Interfaces
- Managed Protocol Interfaces
- SNMP Interfaces
- Applet Integration Interfaces

Java Dynamic Management Kit - A Java agent toolkit for rapid development of autonomous Java agents for system, application, or network devices.

# Inter-domain Management task force (XoJIDM)

Sponsored by X/Open and the Network Management Forum (NMF), see

*Inter-Domain Management*, Open Group Technical Standard, C802 ISBN 1-85912-256-6  
January 2000 524 pages.

They have specified such things as SNMP MIBS to CORBA-IDL conversion,  
CORBA-IDL to GDMO/ASN.1 conversion, CORBA/SNMP Gateway, . . . .

# Policy Based Management

See the recent exjobb report “Implementing policy-based network management” by Yavor Adel Al-Shaikhly

Check Point’s <http://www.checkpoint.com/products/management/index.html> policy management framework

“*Policy Agents: Licensed to Manage/Policy Based Management of Distributed Systems*” by Morris Sloman. Department of Computing, Imperial College, London, U.K.

Cisco’s “*CiscoAssure Policy Networking: Enabling Business Applications through Intelligent Networking*”



# Applications

- E-mail
  - E-mail was invented by Ray Tomlinson of BBN in 1972.
  - His e-mail utility program permits listing, forwarding, and responding to e-mails
  - It was demonstrated at International Computer Communication Conference (ICCC) that year.
  - It become the first “killer application” of the Internet.
- Telnet and FTP
- Networked File systems (such as NFS)
- X windowing system
- Web browsers
  - The first graphical Web browser (called Mosaic) is introduced in 1993
  - It was developed at the National Center for Supercomputing at the University of Illinois.

# Voice over IP (VoIP)

First we will set the context and then we will examine the technical details.

## VoIP End-to-End Architecture

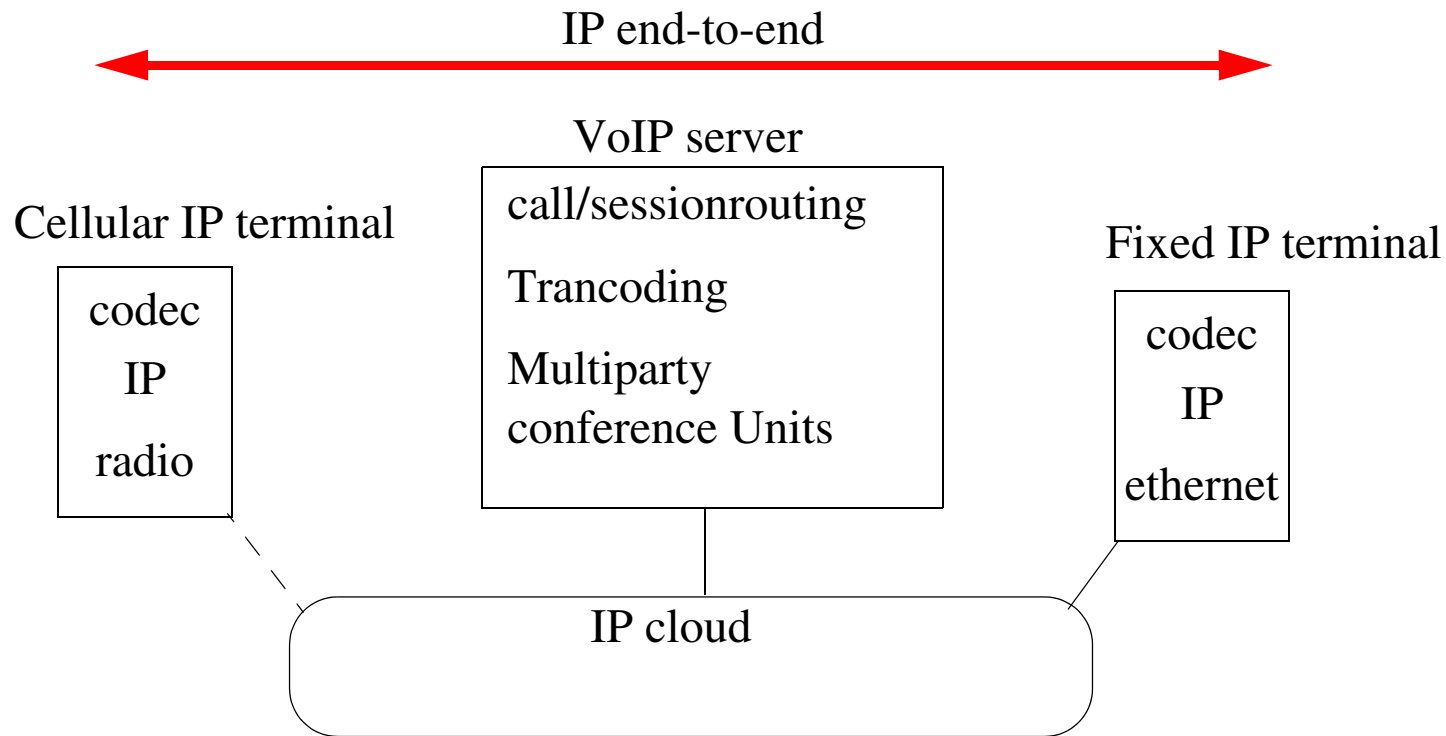

# Deregulation ⇒ New regulations

- US Telecommunications Act of 1996<sup>1</sup>
  - “The goal of this new law is to let anyone enter any communications business -- to let any communications business compete in any market against any other.”<sup>2</sup>
  - updated the Communications Act of 1934
- New interconnection points
  - perhaps there is something that LECs can do with all the empty space in their central exchanges [which appeared due to the shrinking size of their own switching equipment]
- Number portability - even local numbers
  - every call results in ~10 DB lookups
- “Universal Service”
  - from a myth to a legal requirement
  - an evolving service level - not a fixed service or service level!
  - special subsidies for schools, health care, libraries, etc.
- February 1997 World Trade Organization (WTO) agreement<sup>3</sup>

---

1. The official citation for the new Act is: Telecommunications Act of 1996, Pub. LA. No. 104-104, 110 Stat. 56 (1996).

2. <http://www.fcc.gov:80/telecom.html>

3. For informal background see “WTO negotiations on basic Telecommunications” - <http://www.wto.org/wto/services/tel.htm>

# Deregulation continued

⇒ New operators

Lots of new actors as operators

⇒ New Suppliers

Lots of new actors as equipment suppliers

Traditional telecom equipment vendors buying datacom vendors:

Lots of mergers and acquisitions among datacom vendors.

# Latency

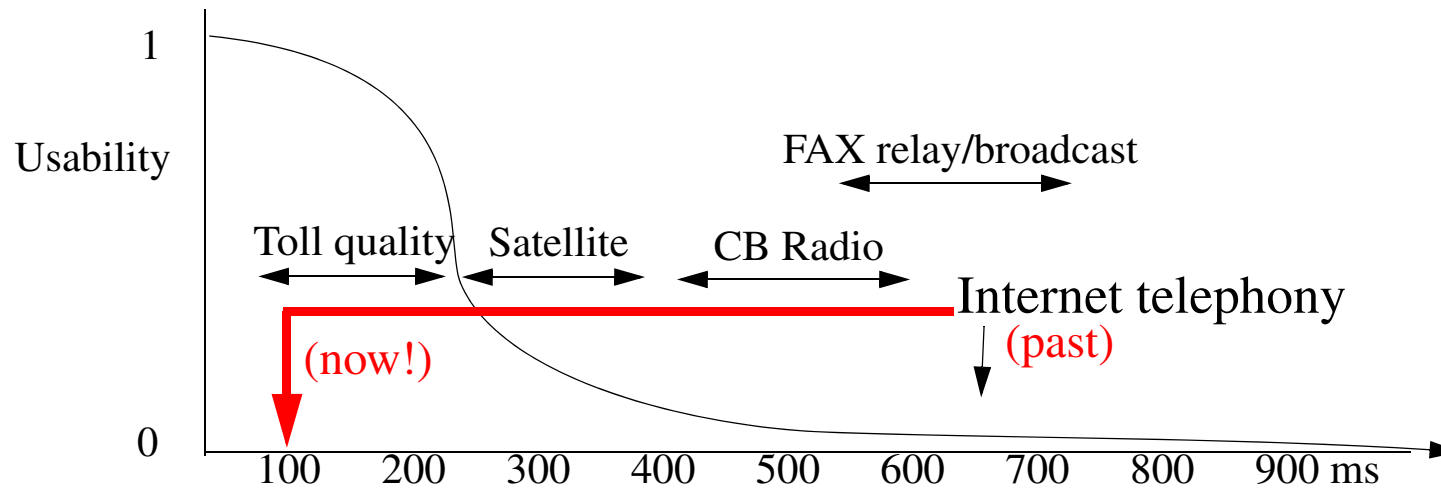

Figure 2: Usability of a voice circuit as a function of end-to-end delay (adapted from a drawing by Cisco)<sup>a</sup>

a. <http://www.packeteer.com/solutions/voip/sld006.htm>

However:

| Round-trip   | min (ms) | avg (ms) | max (ms) | hops |
|--|----------|----------|----------|------|
| Local LAN  | 1        | 1        | 3        | 0    |
| to northern Sweden (basil.cdt.luth.se)                               | 21       | 25       | 41       | 8    |
| to Austria (freebee.tu-graz.ac.at)                                   | 73       | 109      | 353      | 18   |
| To server in US network  | 131      | 306      | 526      | 19   |
| To my machine in the US (~30 ms is the ISDN link)                    | 175      | 328      | 600      | 21   |
| To KTH's subnet at Stanford University in the US (ssvl.stanford.edu) | 166      | 170      | 217      | 20   |

# Increasingly IP based data+voice infrastructure

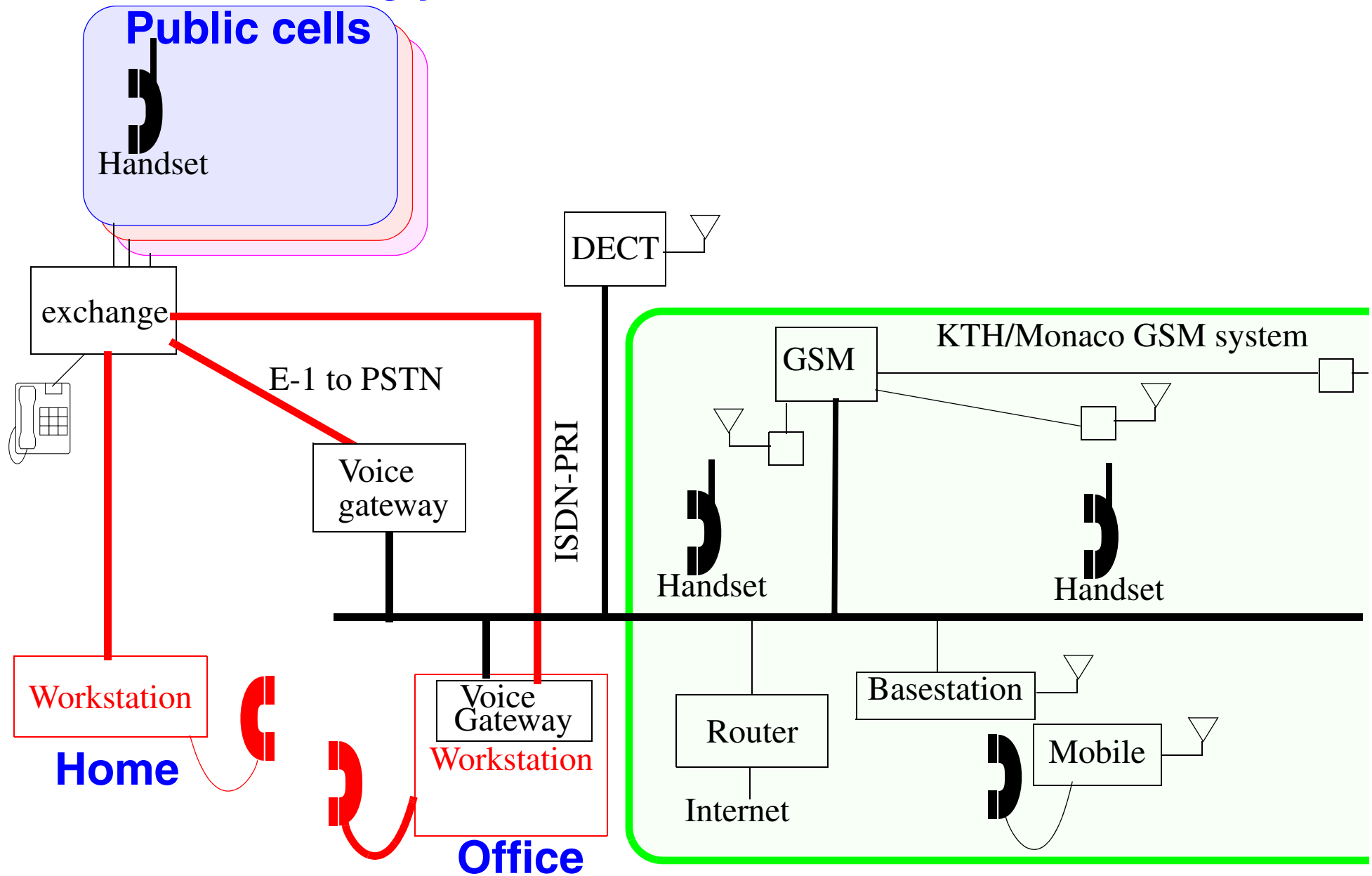

# Voice Gateway

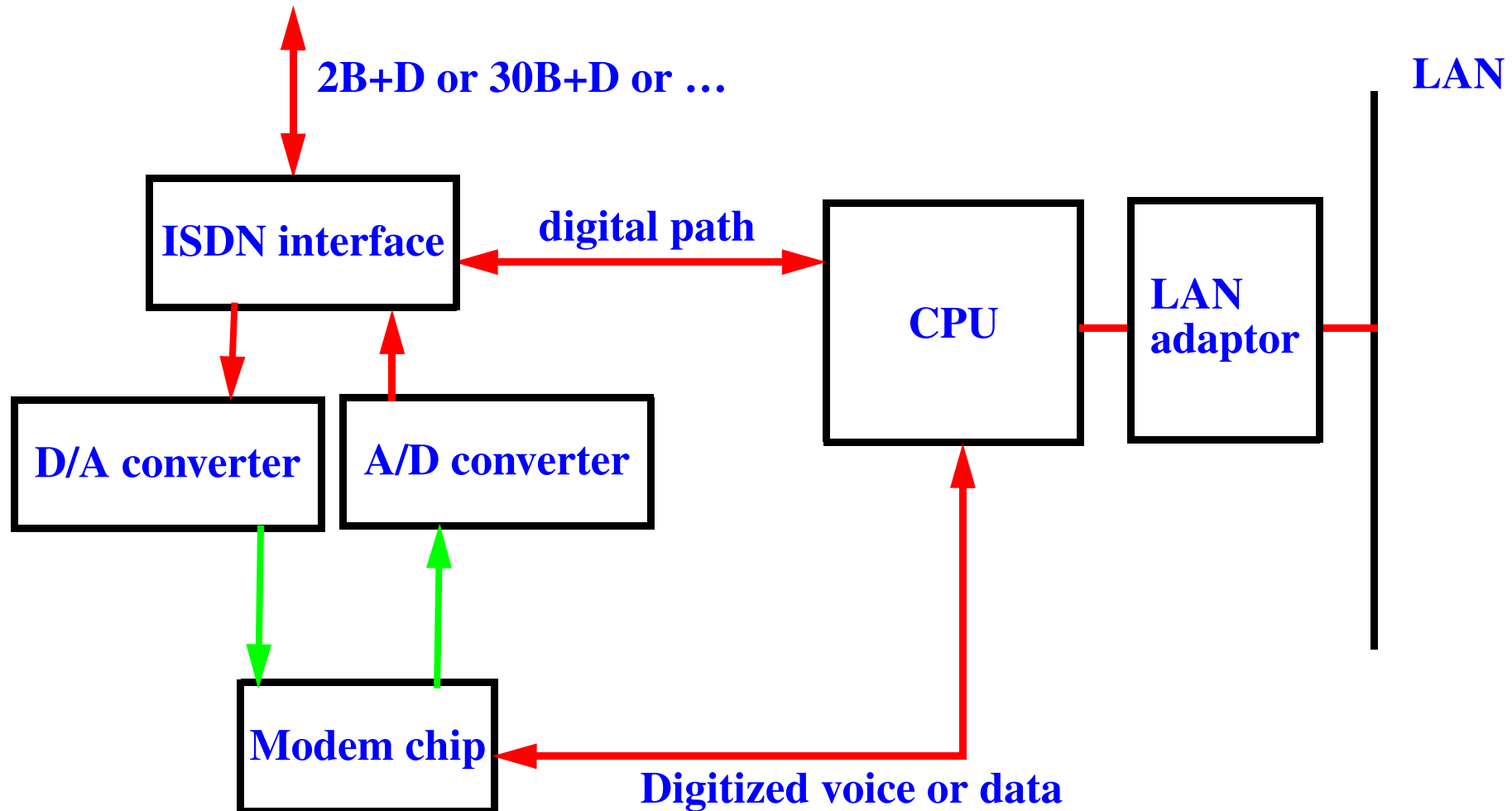

Use access servers such as Ascend Communications MAX, filled with digital modems (currently used for current analog modem pools) as voice gateways [see Ascend's MultiVoice Application for the MAX]

# Voice over IP (VOIP)

Gateways not only provide basic telephony and fax services but can also will enable lots of value-added services, e.g., call-centers, integrated messaging, least-cost routing, ... .

Such gateways provide three basic functions:

- Interface between the PSTN network and the Internet

Terminate incoming synchronous voice calls, compress the voice, encapsulate it into packets, and send it as IP packets. Incoming IP voice packets are unpacked, decompressed, buffered, and then sent out as synchronous voice to the PSTN connection.

- Global directory mapping

Translate between the names and IP addresses of the Internet world and the E.164 telephone numbering scheme of the PSTN network.

- Authentication and billing

## Voice representation

ITU G.723.1 algorithm for voice encoding/decoding or G.729 (CS-ACELP voice compression).

## Signaling

Based on the H.323 standard on the LAN and conventional signaling will be used on telephone networks.



## Fax Support

Both store-and-forward and real-time fax modes - with store-and-forward the system records the entire FAX before transmission.

## Management

Full SNMP management capabilities via MIBs (Management Information Base) will be provided to control all functions of the Gateway. Extensive statistical data will be collected on dropped calls, lost/resent packets, and network delays.

## Compatibility

De jure standards:

- ITU G 723.1/G.729 and H.323
- VoIP Forum IA 1.0

De facto standards:

- Netscape's Cooltalk
- Microsoft's NetMeeting

A protocol to keep you eyes on: **Session Initiation Protocol** (SIP) [RFC 2543], much simpler than H.323

# VOIP Modes of Operation

- PC to PC
- PC-to-Telephone calls
- Telephone-to-PC calls
- Telephone-to-Telephone calls via the Internet
- Premises to Premises
  - use IP to tunnel from one PBX/Exchange to another
- Premises to Network
  - use IP to tunnel from one PBX/Exchange to a gateway of an operator

# Cisco Voice Over IP

Enables Cisco 3600 series routers to carry live voice traffic (e.g., telephone calls and faxes) over an IP network.

They state that this could be used for:

- “Toll bypass
- Remote PBX presence over WANs
- Unified voice/data trunking
- POTS-Internet telephony gateways”

Uses Real-Time Transport Protocol (RTP) for carrying packetized audio and video traffic over an IP network.

Cisco 3600 supports a selection of CODECs:

- G.711 A-Law 64,000 bits per second (bps)
- G.711 u-Law 64,000 bps
- G.729 8000 bps

Cisco 3800 supports even more CODECs:

- ITU G.726 standard, 32k rate
- ITU G.726 standard, 24k rate
- ITU G.726 standard, 16k rate
- ITU G.728 standard, 16k rate (default)
- ITU G.729 standard, 8k rate

By using Voice Activity Detection (VAD) - you only need to send traffic if there is something to send.

An interesting aspect is that user's worry when they hear absolute silence, so to help make them comfortable it is useful to play noise when there is nothing to output. Cisco provide a “**comfort-noise** command to generate background noise to fill silent gaps during calls if VAD is activated”.

Cisco 3600 series router can be used as the voice gateway with software such as Microsoft NetMeeting.

Cisco 3800 also supports “fax-relay” - at various rates either current voice rate or

2,400/4,800/7,200/9,600/14,400 bps fax rates.

For further information see

[http://www.cisco.com/univercd/cc/td/doc/product/software/ios113ed/113t/113t\\_1/voip/config.htm](http://www.cisco.com/univercd/cc/td/doc/product/software/ios113ed/113t/113t_1/voip/config.htm)

# Intranet Telephone System

On January 19, 1998, *Symbol Technologies* and Cisco Systems announced that they had combined the Symbol Technologies' NetVision™ wireless LAN handset and Cisco 3600 to provide a complete wireless local area network telephone system based on Voice-Over-IP technology. (*White Paper*)

The handset use wireless LAN (IEEE 802.11) infrastructure and a voice gateway via Cisco 3600 voice/ fax modules. The system conforms to H.323.

"I believe that this is the first wireless local area network telephone based on this technology" -- Jeff Pulver

Seamless roaming via Symbol's pre-emptive roaming algorithm with load balancing.

Claim each cell can accommodate ~25 simultaneous, full-duplex phone calls.

Current Ericsson is a partner with Symbol, using Ericsson's *WebSwitch2000*

# Wireless LANs

“The wireless workplace will soon be upon us<sup>1</sup>

Telia has strengthened its position within the area of radio-based data solutions through the acquisition of Global Cast Internetworking. The company will primarily enhance Telia Mobile’s offering in wireless LANs and develop solutions that will lead to the introduction of the wireless office. A number of different alternatives to fixed data connections are currently under development and, *later wireless IP telephony will also be introduced.*

...

The acquisition means that Telia Mobile has secured the resources it needs to maintain its continued expansion and product development within the field of radio-based LAN solutions. *Radio LANs are particularly suitable for use by small and medium-sized companies as well as by operators of public buildings such as airports and railway stations.*

Today’s radio-LAN technology is based on *inexpensive products that do not require frequency certification.* They are *easy to install* and are often used to replace cabled data networks in, for example, large buildings.

...”

[*emphasis added by Maguire*]

---

1. Telia press announcement: 1999-01-25

# Telia's HomeRun

<http://www.homerun.telia.com/>

A subscription based service to link you to your corporate network from airports, train stations, ferry terminals, hotels, conference centers, etc.

Look for Telia's HomeRun logo:





# Carriers offering VOIP

“Equant, a network services provider, will announce tomorrow that it is introducing voice-over-frame relay service in 40 countries, ...

The company says customers can save 20% to 40% or more by sending voice traffic over its frame relay network. "This is the nearest you're going to get to free voice," says Laurence Huntley, executive VP of marketing for Equant Network Service.

The Equant service uses the Cisco Systems 3810 router, which takes the customer's voice and data traffic and integrates them before putting the traffic on the Equant network. **Equant is also working with Cisco to introduce a voice-over-IP service.** ...

Equant isn't alone in its pursuit to send voice traffic over data networks. Most of the major carriers are testing services that would send voice over data networks. ... .”<sup>1</sup>

AT&T VoIP phone: [http://www.telephones.att.com/new\\_prod.html](http://www.telephones.att.com/new_prod.html)

Deutsche Telekom running a pilot Internet telephony service using networking products from Ascend Communications and VocalTec.

---

1. Mary E. Thyfault, Equant To Roll Out Voice-Over-Frame Relay Service, InformationWeek Daily, 10/21/98.

# VOIP vs. traditional telephony

In “*Telcos Hear New Voices*” by Margrit Sessions, Phillips Tarifica Ltd., she predicts that by 2001, Internet telephony could squeeze nearly US\$1.2 billion in revenue out of 16 international service providers, while losses due to e-mail (US\$463 million) and Internet fax (US\$170 million) will be much less.

Expected loss of international call revenue due to: Internet phone, fax, and e-mail, by operator:

| Company                                      | Expected Losses<br>(millions of US Dollars) | Loss as a percentage of<br>revenue |
|--|---|------------------------------------|
| AT&T   | ~350  | 3.6%                               |
| Kokusai Denshin Denwa (KDD) Co. Ltd. (Japan) | ~307  | 10.4%                              |
| Deutsche Telekom                             | ~175  | 4.2%                               |
| Telstra Corp. (Australia)                    | ~168  | 9%                                 |
| Embratel (Brazil)                            | ~28   | 11.5%                              |
| Bezeq (Israel)                               | ~30   | 10.7%                              |

# Economics

"Can Carriers Make Money On IP Telephony? by Bart Stuck and Michael Weingarten, Business Communication Review, Volume 28, Number 8, August 1998, pp. 39-44 - <http://www.bcr.com/bcrrmag/08/98p39.htm>

"What is the reality in the battle over packet-versus-circuit telephony, and what is hype?

Looking at the potential savings by cost element, it is clear that in 1998, access arbitrage is the major economic driver behind VOIP. By 2003, we anticipate that switched-access arbitrage will diminish in importance, as the ESP exemption disappears and/or access rates drop to true underlying cost.

However, we believe that the convergence between voice and data via packetized networks will offset the disappearance of a gap in switched access costs. As a result, VOIP will continue to enjoy a substantial advantage over circuit-switched voice. Indeed, as voice/data convergence occurs, we see standalone circuit-switched voice becoming economically nonviable."

# Conferences

VON (Voice on the Net)

# Patents

Mixing voice and data in the LAN goes back to at least this patent:

4581735 : Local area network packet protocol for combined voice and data transmission

INVENTORS:

Flamm; Lois E., Chatham Township, Morris County, NJ

Limb; John O., Berkeley Heights, NJ

ASSIGNEES: AT&T Bell Laboratories, Murray Hill, NJ

ISSUED: Apr. 8 , 1986

FILED: May 31, 1983

ABSTRACT: In order to control the transfer of packets of information among a plurality of stations, the instant communications system, station and protocol contemplate first and second oppositely directed signal paths. At least two stations are coupled to both the first and the second signal paths. A station reads one signal from a path and writes another signal

on the path. The one signal is read by an arrangement which electrically precedes the arrangement for writing the other signal. Packets are transmitted in a regular, cyclic sequence. A head station on a forward path writes a start cycle code for enabling each station to transmit one or more packets. If a station has a packet to transmit, it can read the bus field of a packet on the forward path. Responsive thereto, a logical interpretation may be made as to whether the forward path is busy or is not busy. If the path is not busy, the packet may be written on the path by overwriting any signal thereon including the busy field. If the path is busy, the station may defer the writing until the path is detected as not busy. In order to accommodate different types of traffic, the head station may write different start cycle codes. For example, a start-of-voice code may enable stations to transmit voice packets; a start-of-data code may enable stations to transmit data packets, etc. for the different types of traffic. Further, the start cycle codes may be written in a regular, e.g., periodic, fashion to mitigate deleterious effects, such as speech clipping. Still further, the last station on the forward path may write end cycle codes in packets on a reverse path for communicating control information to the head station. Responsive to the control information, the head station may modify the cycle to permit the respective stations to, for example, transmit more than one packet per cycle or to vary the number of packet time slots, which are allocated to each of the different types of traffic.

# Deregulation ⇒ Trends

- replacing multiplexors with **Routers/Switches/...** << 1/10 circuit swi. cost
- **Standard telco interfaces being replaced by datacom interfaces**
- New Alliances
- future developments building on VOIP
  - ◆ Fax broadcast, Improved quality of service, Multipoint audio bridging, Text-to-speech conversion and Speech-to-Text conversion, Voice response systems, ...
  - ◆ Replacing the wireless voice network's infrastructure with IP

See the Univ. of California at Berkeley ICEBERG project report:

<http://iceberg.cs.berkeley.edu/release/>

⇒ Telecom (only) operators have no future

⇒ Telecom (only) companies have no future

# VoIP details

Carry the speech frame inside an RTP packet

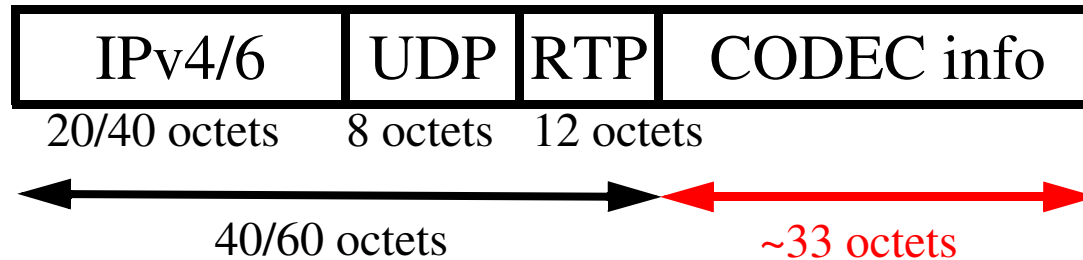

Typical packetisation time of 10-20ms per audio frame.

See <http://www.ietf.org/ids.by.wg/avt.html>



# RTP: Real-Time Transport Protocol

Designed to carry out variety of real-time data: audio and video.

Provides two key facilities:

- Sequence number for order of delivery
- Timestamp for control playback

Provides no mechanisms to ensure timely delivery.

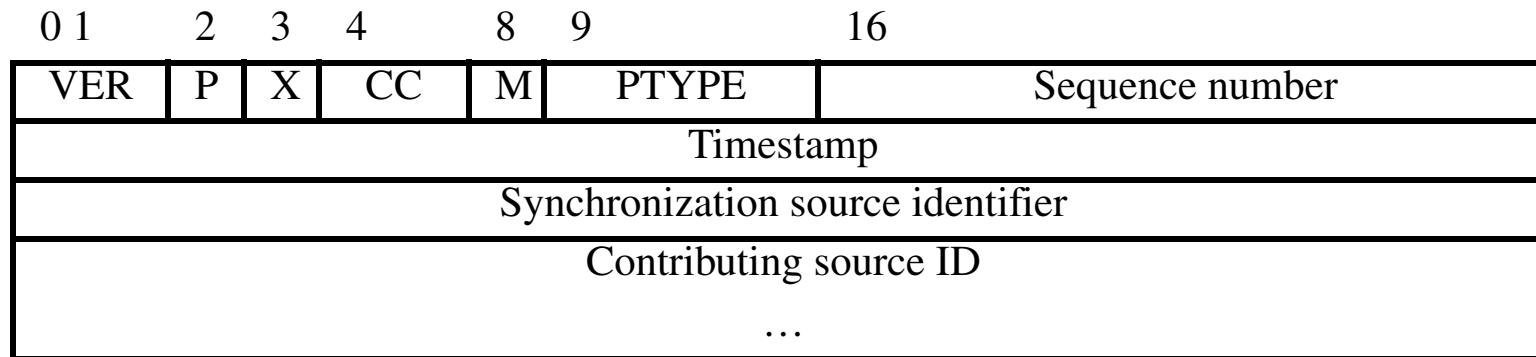

- P - whether zero padding follows the payload.
- X - whether extension or not.
- M - marker for beginning of each frame.
- PTYPE - Type of payload.

# RTP and H.323 for IP Telephony

|                          |             |                       |                    |                 |               |                   |
|--------------------------|-------------|-----------------------|--------------------|-----------------|---------------|-------------------|
| audio/video applications |             | signaling and control |                    |                 |               | data applications |
| video code               | audio codec | RTCP                  | H.225 registration | H.225 Signaling | H.245 Control | T.120             |
| RTP                      |             |                       |                    |                 |               |                   |
| UDP                      |             |                       |                    | TCP             |               |                   |
| IP                       |             |                       |                    |                 |               |                   |

- H.323 is the framework of a group protocols for IP telephony (from ITU)
- H.225 - Signaling used to establish a call
- H.245 - Control and feedback during the call
- T.120 - Exchange of data associated with a call
- RTP - Real-time data transfer
- RTCP - Real-time Control Protocol

# SIP: Session Initiation Protocol

SIP is an alternative to H.323 proposed by IETF. Only covers signaling (parts of H.323). Does not use RTP (but **sessions** can use RTP)

Several types of servers defined:

- **User agent server** runs on a SIP terminal = a client element, User Agent Client (UAC) + server element, User Agent Server (UAS)
- SIP proxy - interprets, and, if necessary, rewrites specific parts of a request message before forwarding it to a server closer to the destination:
  - SIP stateful proxy server - remembers its queries and answer; can also forward several queries in parallel.
  - SIP stateless proxy server
- SIP redirect server - directes the client to contact an alternate URI
- Location server - knows the current binding (from REGISTER msgs)

SIP uses SDP (Session Description Protocol) to get information about a call, such as, the media encoding, protocol port number, multicast addresses, etc.

# SIP timeline

Alice invites Bob to a SIP session:

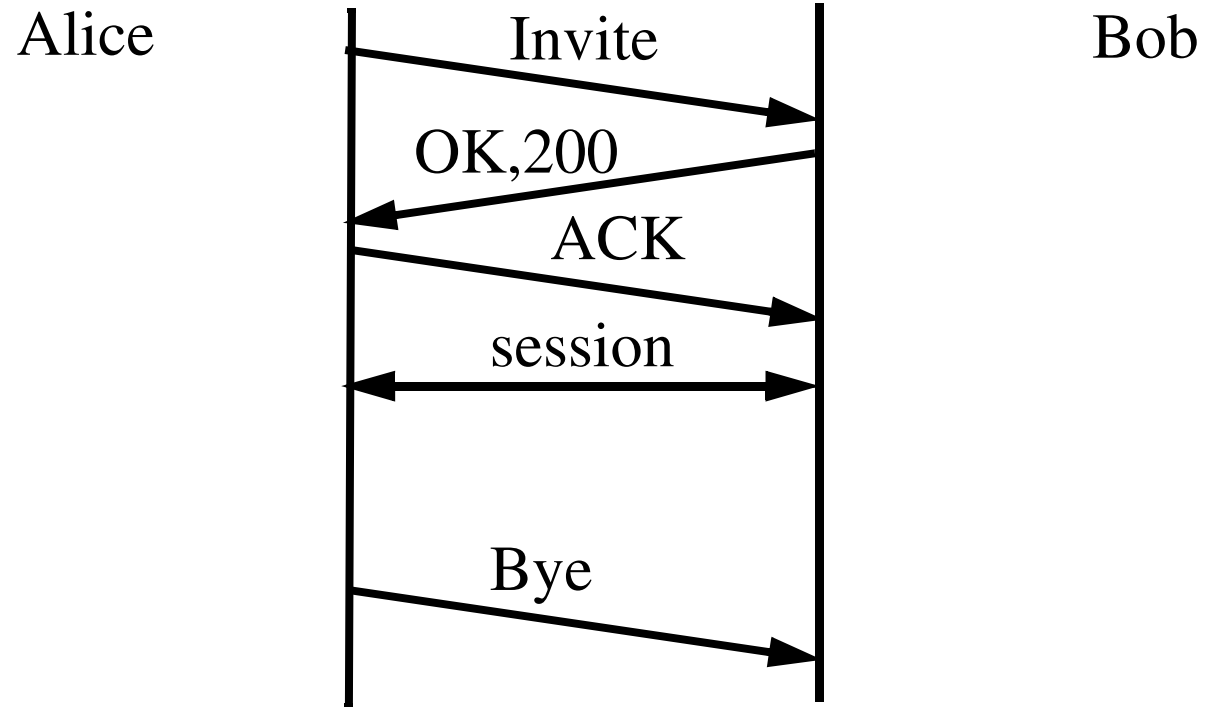

# SIP Invite<sup>1</sup>

```
INVITE sip:bob@biloxi.com SIP/2.0
Via: SIP/2.0/UDP pc33.atlanta.com;branch=z9hG4bK776asdhds
To: Bob <sip:bob@biloxi.com>
From: Alice <sip:alice@atlanta.com>;tag=1928301774
Call-ID: a84b4c76e66710
CSeq: 314159 INVITE
Contact: <sip:alice@pc33.atlanta.com>
Content-Type: application/sdp
Content-Length: 142
```

(Alices SDP not shown)

SIP is a text-based protocol and uses ISO 10646 character set in UTF-8 encoding (RFC 2279). The message body uses MIME and *can* use S/MIME for security.

The generic form of a message is:

```
generic-message = start-line
                  message-header*
                  CRLF
                  [ message-body ]
```

---

1. Example from draft-ietf-sip-rfc2543bis-06.ps

# Bob's response<sup>1</sup>

```
SIP/2.0 200 OK Via: SIP/2.0/UDP
pc33.atlanta.com;branch=z9hG4bK776asdhds
Via: SIP/2.0/UDP
bigbox3.site3.atlanta.com;branch=z9hG4bK77ef4c2312983.1
Via: SIP/2.0/UDP pc33.atlanta.com;branch=z9hG4bKnashds8
To: Bob <sip:bob@biloxi.com>;tag=a6c85cf
From: Alice <sip:alice@atlanta.com>;tag=1928301774
Call-ID: a84b4c76e66710
CSeq: 314159 INVITE
Contact: <sip:bob@192.0.2.8>
Content-Type: application/sdp
Content-Length: 131
```

(Bobs SDP not shown)

---

1. Example from draft-ietf-sip-rfc2543bis-06.ps

# SIP Methods

| <b>Method</b> | <b>Purpose</b>   |
|---------------|--|
| Invite        | Invites a user to join a call.   |
| Bye           | Terminates the call between two of the users on a call.                                  |
| Options       | Requests information on the capabilities of a server.                                    |
| Ack           | Confirms that a client has received a final response to an INVITE.                       |
| Register      | Provides the map for address resolution, this lets a server know the location of a user. |
| Cancel        | Ends a pending request, but does not end the call.                                       |

# SIP Status codes

SIP status codes are patterned on and similar to HTTP's status codes:

|     |  |
|-----|--|
| 1xx | Provisional request received, continuing to process the request                      |
| 2xx | Success - the action was successfully received, understood, and accepted             |
| 3xx | Redirection - further action needs to be taken in order to complete the request      |
| 4xx | Client Error - the request contains bad syntax or cannot be fulfilled at this server |
| 5xx | Server Error - the server failed to fulfill an apparently valid request              |
| 6xx | Global Failure - the request cannot be fulfilled at any server                       |



# ENUM

IETF's E.164 Number Mapping standard uses Domain Name Server (DNS) to map standard International Telecommunication Union (ITU-T) international public telecommunications numbering plan (E.164) telephone numbers to a list of Universal Resource Locators (URL). SIP then uses those URL's to initiate sessions.

For example, ENUM DNS converts a telephone number in E.164 format, e.g. [+46812345](#), and returns e.g., a Universal Resource Identifier (URI) [SIP:olle.svenson@telia.se](#)

Then a SIP client can make a connection to the SIP gateway [telia.se](#) passing the local part [olle.svenson](#).

ENUM can return a wide variety of URI types.

# Further Reading

IP Telephony (*iptel*)

PSTN and Internet Internetworking (*pint*)

Also important are the measures of delay, delay jitter, throughput, packet loss, etc. IP Performance Metrics (*ippm*) is attempting to specify how to measure and exchange information about measurements of these quantities.

A great set of references compiled by prof. Raj Jain is available at:

[http://www.cis.ohio-state.edu/~jain/refs/ref\\_voip.htm](http://www.cis.ohio-state.edu/~jain/refs/ref_voip.htm)

# Web Services

Using protocols built on top of HTTP or HTTPs, such as:

- Atom/AtomPub - see [2], RFCs 4287[3] and 5023[4]
- JavaScript Object Notation (JSON) - see RFC 4627[5] and JSON.org
- Simple Object Access Protocol (SOAP) [6]
- Representational State Transfer (REST) protocol [7][8]

# Twitter

Twitter is a service based upon 140 character message (the length is derived from the capacity of SMS).

- A social network based service providing two way communication.
- Both public and private "tweets"
- Search engines can process public tweets
- Three APIs: REST API, Search API, Streaming API

See for example: Paul McFedries, [twitter: Tips, Tricks, and Tweets](#) [1]

Twitter is now serving as a base protocol for other services.

- Micropayments - such as Twitpay and Twippr (due to PayPal opening opening up their code for other developers).
-

# Summary

This lecture we have discussed:

- Network Management
- SNMP
- VoIP (including RTP)
- Twitter

# References

- [1] Paul McFedries, *twitter: Tips, Tricks, and Tweets*, Wiley Publishing Inc., 2009, ISBN 978-0-470-52969-0
- [2] Ben Hammersley, *Developing Feeds with RSS and Atom*, O'Reilly Media, April 2005, 272 pages
- [3] M. Nottingham and R. Sayre (Editors), *The Atom Syndication Format*, IETF, Network Working Group, Request for Comments: 4287, December 2005. <http://www.ietf.org/rfc/rfc4287.txt>
- [4] J. Gregorio and B. de Hora (Editors), *The Atom Publishing Protocol*, IETF, Network Working Group, Request for Comments: 5023, October 2007. <http://www.ietf.org/rfc/rfc5023.txt>
- [5] D. Crockford, *The application/json Media Type for JavaScript Object Notation (JSON)*, IETF, Network Working Group, Request for Comments: 4627, July 2006. <http://www.ietf.org/rfc/rfc4627.txt>
- [6] D. Box, D. Ehnebuske, G. Kakivaya, A. Layman, N. Mendelsohn, H. Nielsen, S. Thatte, and D. Winer, "Simple Object Access Protocol (SOAP) 1.1", May 2000. <http://www.w3.org/TR/2000/NOTE-SOAP-20000508>
- [7] Alex Rodriguez, *RESTful Web services: The basics*, Web page, IBM, 06 Nov 2008  
<http://www.ibm.com/developerworks/webservices/library/ws-restful/>
- [8] Leonard Richardson and Sam Ruby, *RESTful Web Services: Web services for the real world*, O'Reilly Media, May 2007, 448 pages.
- [9]

# IK1550 Internetworking/Internetteknik

## Spring 2010, Period 4

### Module 10: IPv6

Lecture notes of G. Q. Maguire Jr.



**KTH Information and  
Communication Technology**

© 2010 G.Q.Maguire Jr. .

All rights reserved. No part of this course may be reproduced, stored in a retrieval system, or transmitted, in any form or by any means, electronic, mechanical, photocopying, recording, or otherwise, without written permission of the author.

Last modified: 2010.03.21:17:37

# Lecture 6: Outline

- IPv6



# Internet Protocol Version 6 (IPv6)

- Successor of current IPv4
- Internet needs to change IP in order to continue growth
- Defines a transition from IPv4 to IPv6

Specified by RFC 2460: Internet Protocol, Version 6 (IPv6) Specification, December 1998[1].

# Growth

- Currently IPv4 serves a market doubling every ~12 months
- In addition, new and very large markets are developing rapidly:
  - Nomadic Computing
  - Networked Entertainment
  - Device Control

# Nomadic Computing

- Wireless computers
  - supporting multimedia
  - replacing pagers, cellular telephones, ...
- IPv6 includes support for mobility
  - low overhead (?)
  - auto configuration
  - mobility

# Networked Entertainment

Your TV will be an Internet Host!

[consider the network attached Personal Video Recorders (PVR), such as TiVo's DVR, SONICblue's ReplayTV, Sony's SVR-2000, Philips' PTR, ...)]

- 500 channels of television
- large scale routing and addressing
- auto-configuration
- requires support for real-time data

SonicBlues's ReplayTV 4000 a networked Digital Video Recorder (DVR) {i.e., coder/decoder + very big disk) that takes advantage of your broadband Internet connection - enables you to capture and transfer videos.

Providing “narrowcast” content via broadband  $\Rightarrow$  all the time is “primetime”.

# Device Control

- Control everyday devices for
  - lightning, heating and cooling, motors, ...
  - new street light controllers already have IP addresses!
  - electrical outlets with addresses
  - networked vehicles (within the vehicle<sup>1</sup>, between vehicles, and vehicles to infrastructure)<sup>2</sup>
- Market size is enormous
- Solution must be
  - simple, robust, easy to use
  - very low cost
  - potential power savings by (remote) network management based control may be quite large

There is already a networked: Toaster, a Coke machine, ... .

---

1. On-Board Diagnostic systems (OBD-II), see slide 8 [2]

2. See InternetCAR, slide 4 (showing a Yokohama City bus) [2]

# IPv6 features

- **Expanded Addressing Capabilities**
  - 128 bit address length
  - supports more levels of hierarchy
  - improved multicast routing by using a **scope** field
  - new cluster addresses to identify topological regions
- **Header Format Simplification**
  - some IPv4 fields have been dropped, some made optional
  - header is easier to compute
- **Improved Support for Extensions and Options**
  - more efficient for forwarding of packets
  - less stringent limits to length of options
  - greater flexibility for introduction of future options
- **Flow Labeling Capability**
  - labeling of packets belonging to a particular “flow”
  - allows special handling of, e.g., real-time, packets
- **Authentication and Privacy Capabilities**
  - Extensions to support authentication, data integrity, and (optional) data confidentiality

# IPv6 header format

|  |                 |                       |                     |
|--|-----------------|-----------------------|---------------------|
| version<br>4 bits                      | Class<br>8 bits | flow label<br>20-bits |                     |
| "payload" length (in octets)<br>16 bit |                 | next header<br>8 bits | hop limit<br>8 bits |
| Source Address<br>128 bits             |                 |                       |                     |
| Destination Address<br>128 bits        |                 |                       |                     |

IPv6 header (total length = 40 bytes)

IPv6: 6 fields + 2 addresses

versus

IPv4: 10 fixed fields + 2 addresses + options

# Demultiplexing

Initially, it was assumed that by keeping the version field the same that IPv4 and IPv6 could be mixed over the same links with the same link drivers.

However, now IPv6 will be demultiplexed at the link layer:  
hence, IPv6 been assigned the Ethernet type 0x86DD (instead of IPv4's 0x8000)



# Simplifications

IPv6 builds on 20 years of internetworking experience - which lead to the following simplifications and benefits:

| Simplification                        | Benefits  |
|---------------------------------------|---|
| Use fixed format headers              | Use extension headers instead, thus no need for a header length field, simpler to process   |
| Eliminate header checksum             | Eliminate need for recomputation of checksum at each hop (relies on link layer or higher layers to check the integrity of what is delivered)  |
| Avoid hop-by-hop segmentation         | No segmentation, thus you <b>must</b> do <b>Path MTU discovery</b> or only send small packets (1996: 536 octets, 1997: proposed 1500 octets) (for observed PMTUs see [4]) <ul style="list-style-type: none"><li>• This is because we should have units of <b>control</b> based on the units of <b>transmitted</b> data.</li></ul> |
| Eliminate Type of Service (ToS) field | Instead use (labeled) <b>flows</b>  |

# Quality-of-Service Capabilities

- for packet streams
- Flow characterized by **flow id + source address + destination address**
- unique **random** flow id for each source



- Class field

| D (1 bit)       | Network-wide priority (3 bits)  | Reserved (4 bits)   |
|-----------------|---|---|
| Delay sensitive | Encodes the priority of traffic, can be used to provide “Differentiated services” | Researchers would like to use two of these bits for congestion avoidance control: <ul style="list-style-type: none"><li>◆ one bit which could be set by routers to indicate that congestion was experienced;</li><li>◆ the other bit could be used by the source to mark that it is “ready to adapt”.</li></ul> |

- Flow ID - indicates packets which should all be handled the same way.

The original specified in *RFC 1809: Using the Flow Label Field in IPv6*. Subsequently updated - see Chapter 6 of Huitema, **2nd edition**; this change occurred because of Steve McCanne’s SigComm’96 paper [6]. **Note that chapter 27 in Forouzan is incorrect!**

# Payload length

Payload length is the length of the data carried after the header.

As the length field is 16 bits  $\Rightarrow$  maximum packet size of 64 kilobytes; but there is a provision for "**jumbograms**" [via the Hop-by-Hop option header with option type 194]. See RFC 2675 [7].

# IPv4 Protocol type $\Rightarrow$ IPv6 Next Header type

Tells how to interpret the next header which follows, it is either the payload type or the type of the next header. [Payload types use the IPv4 protocol type values]

| Decimal | Keyword | Header type                     |
|---------|---------|---------------------------------|
| 0       | HBH     | Hop-by-hop options              |
| 2       | ICMP    | IPv6 ICMP                       |
| 3       | GGP     | Gateway-to-Gateway Protocol     |
| 5       | ST      | Stream                          |
| 6       | TCP     | Transmission Control Protocol   |
| 17      | UDP     | User Datagram Protocol          |
| 43      | RH      | IPv6 Routing Header             |
| 44      | FH      | IPv6 Fragmentation Header       |
| 45      | IDRP    | Inter-domain Routing Protocol   |
| 51      | AH      | Authentication Header           |
| 52      | ESP     | Encrypted Security Payload      |
| 59      | Null    | No next Header (IPv6)           |
| 60      |         | IPv6 Destination Options Header |
| 88      | IGRP    | IGRP                            |
| 89      | OSPF    | Open Shortest Path First        |
| 255     |         | Reserved                        |

# Extension headers

- Each header is a multiple of 8 octets long
- order (after IPv6 header):
  - Hop-by-hop option,
  - Destination options header (1)
  - Routing header,
  - Fragment header,
  - Authentication header,
  - Encapsulating security payload header,
  - Destination options header (2)
  - Followed by the upper layer header (e.g., TCP, UDP, ...)

So a TCP packet looks like:

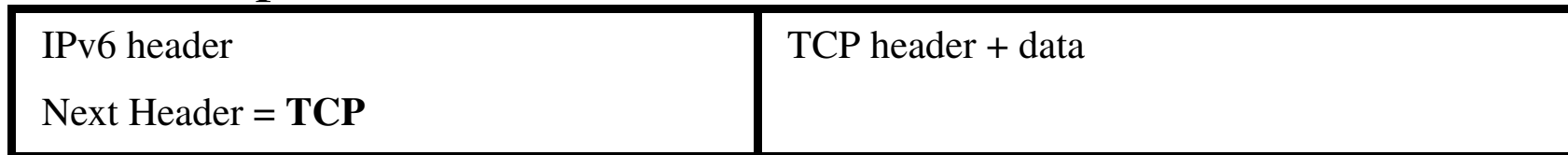

If we wanted to explicitly route the above packet, we simply add a routing header:

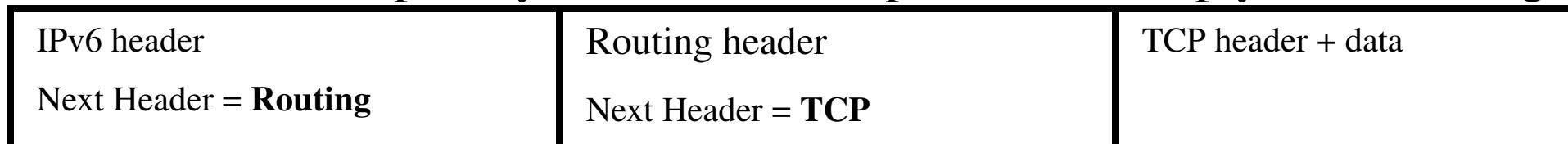

# Addressing

- 128 bits long
- three types: unicast, multicast, anycast

|           |  |
|-----------|--|
| Unicast   | identifies exactly one interface   |
| Multicast | identifies a group of interfaces; a packet sent to a multicast address will be delivered to all members of the group |
| Anycast   | delivered to the nearest member of the group   |

- $2^{96}$  times more addresses than IPv4 are available !!!

IPv6 addresses per  $m^2$

Earth: 511,263,971,197,990  $m^2$

$\Rightarrow$  665,570,793,348,866,943,898,599 /  $m^2$

- pessimistic estimate with hierarchies:  $\sim 1,564$  addresses /  $m^2$
- optimistic: 3,911,873,538,269,506,102 /  $m^2$

# Writing an IPv6 address

The 128 bit IPv6 address is written as eight 16 bit integers using hexadecimal digits.

The integers are separated by colons, for example:

2001:0DB8:7654:3210:FEDC:BA98:7654:3210

A number of abbreviations are allowed:

- leading zeros in integers can be suppressed
- a **single** set of consecutive 16 bit integers with the value null, can be replaced by double colon, i.e.,  
2001:DB8:0:0:0:0:7654:3210 becomes 2001:DB8::7654:3210
- When an IPv4 address is turned into an IPv6 address we prepend 96 bits of zero; but we can write it as:  
::10.0.0.1 - hence combining dotted-decimal and IPv6 forms
- Prefixes can be denoted in the same manner as for IPv4, i.e., CIDR:  
2001:DB8::/32 - for a 32 bit long prefix

# Address Allocation [17] and [22]

| Binary prefix       | Hex. prefix      | Fraction of address space | Assignment   |
|---------------------|------------------|---------------------------|--|
| 0000 0000           | ::/8             | 1/256                     | Reserved   |
| 0000 0001           | 100::/8          | 1/256                     | Unassigned   |
| 0000 001            | 200::/7          | 1/128                     | Network Service Access Point (NSAP) Allocation-RFC 1888  |
| 0000 01             | 400::/6          | 1/64                      | Unassigned (first half was formerly Novell's IPX)        |
| 0000 1              | 800::/5          | 1/32                      | Unassigned   |
| 0001                | 1000::/4         | 1/16                      | Unassigned   |
| <b>001</b>          | <b>2000::/3</b>  | <b>1/8</b>                | <b>Global Unicast - RFC 2374 see RFC 3587</b>            |
| 010                 | 4000::/3         | 1/8                       | Unassigned (formerly provider based unicast addresses)   |
| 011                 | 6000::/3         | 1/8                       | Unassigned   |
| 100                 | 8000::/3         | 1/8                       | Unassigned (formerly Geographic-based Unicast Addresses) |
| 101                 | A000::/3         | 1/8                       | Unassigned   |
| 110                 | C000::/3         | 1/8                       | Unassigned   |
| 1110                | E000::/4         | 1/16                      | Unassigned   |
| 1111 0              | F000::/5         | 1/32                      | Unassigned   |
| 1111 10             | F800::/6         | 1/64                      | Unassigned   |
| 1111 110            | FC00::/7         | 1/128                     | Unassigned   |
| 1111 1110 0         | FE00::/9         | 1/512                     | Unassigned   |
| <b>1111 1110 10</b> | <b>FE80::/10</b> | <b>1/1024</b>             | <b>Link Local Use Addresses</b>                          |



| Binary prefix | Hex. prefix | Fraction of address space | Assignment                                       |
|---------------|-------------|---------------------------|--|
| 1111 1110 11  | FEC0::/10   | 1/1024                    | Reserved for IANA (was Site Local Use Addresses) |
| 1111 1111     | FF00::/8    | 1/256                     | Multicast Addresses                              |

## Global Unicast Addresses

RFC 2374 defined an IPv6 address allocation structure that which featured Top Level Aggregator (TLAs) and Next Level Aggregator (NLAs) - this has been replaced (see RFC 3587[18]) by a coordinated allocation policy defined by the Regional Internet Registries (RIRs) [19]

The Subnet Local Aggregator (SLAs) of RFC 2374  $\Rightarrow$  now called the “subnet ID”

|                 |                                 |                        |                           |
|-----------------|---------------------------------|------------------------|---------------------------|
| 001<br>(3 bits) | global routing prefix (45 bits) | subnet ID<br>(16 bits) | Interface ID<br>(64 bits) |
|-----------------|---------------------------------|------------------------|---------------------------|

Thus the Regional Internet Registries are allocating addresses from 2000:/3

For a table of IPv6 unicast assignment see

<http://www.iana.org/assignments/ipv6-unicast-address-assignments>

For an analysis of use from the point of view of RIPE see [24]

# Interface ID

Must be unique to the link, but there are some advantages of making it more globally unique.

Hence, most will be based on the IEEE EUI-64 format, but with the “u” (unique) bit inverted.

- The “u” bit is the 7th most significant bit of a 64 bit EUI.
- The inversion was necessary because 0:0:0:0 is a valid EUI, but this would collide with one of the IPv6 special addresses.
- $u=1$ , when the address comes from a valid EUI, and is 0 otherwise.

To go from a 48 bit IEEE 802, you insert 0xFFFE in between the 3rd and 4th octets of an IEEE 802 address, i.e., 123456789abc becomes 123456FFFE789abc.

# Special Address Formats

## Unspecified address

“::” == “0:0:0:0:0:0:0:0” - can only be used as a source address by a station which does not yet have an address

## Loop-back address

0:0:0:0:0:0:0:1 - used to send an IPv6 datagram to yourself

## IPv4-based address

prefix the 32 bit IPv4 address with 96 zero bits

## Site local addresses

Site local address can not be routed on the global internet, but they can be used by sites that are not connected to the internet or for communication within the site.

|                         |                |                     |                           |
|-------------------------|----------------|---------------------|---------------------------|
| 1111111011<br>(10 bits) | 0<br>(38 bits) | Subnet<br>(16 bits) | Interface ID<br>(64 bits) |
|-------------------------|----------------|---------------------|---------------------------|

## Link local addresses

Link local addresses are simply unique to a given link - they can be used by stations that have not yet been assigned a provider-based address.

|                         |                |                           |
|-------------------------|----------------|---------------------------|
| 1111111010<br>(10 bits) | 0<br>(54 bits) | Interface ID<br>(64 bits) |
|-------------------------|----------------|---------------------------|

# Multicast Addresses

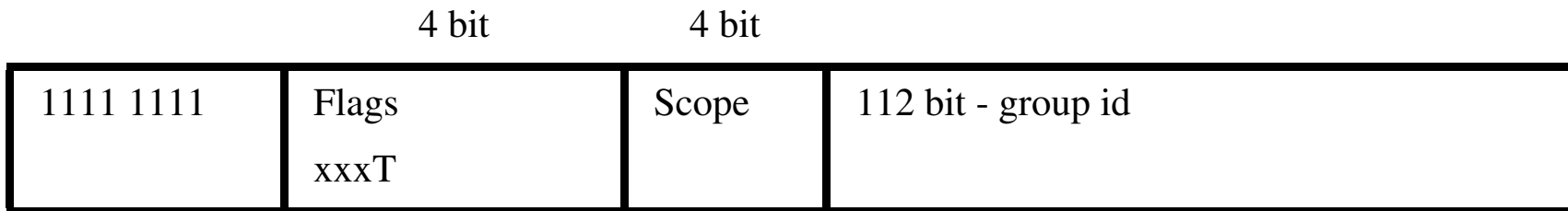

T == Transient

|       |   |
|-------|---|
| T = 0 | well-known permanent - assigned by the IANA |
| T = 1 | non-permanent                               |

| Scope         |                          |
|---------------|--------------------------|
| 0             | reserved                 |
| 1             | node local scope         |
| 2             | link local scope         |
| 3, 4          | unassigned               |
| 5             | site local scope         |
| 6, 7          | unassigned               |
| 8             | organization local scope |
| 9, A, B, C, D | unassigned               |
| E             | global scope             |
| F             | reserved                 |

# Permanently assigned groups

For example, group 0x43 has been assigned to the Network Time Protocol (NTP), hence:

|          |   |
|----------|---|
| FF01::43 | represents all NTP servers on the same node as the sender             |
| FF02::43 | represents all NTP servers on the same link as the sender             |
| FF05::43 | represents all NTP servers on the same site as the sender             |
| FF08::43 | represents all NTP servers within the same organization as the sender |
| FF0E::43 | represents all NTP servers in the Internet                            |

IANA has assigned a whole series of group identifiers, including:

|                  |  |
|------------------|--|
| FF0X:0:0:0:0:0:0 | Reserved multicast address - this can not be used within any scope |
| FF01:0:0:0:0:0:1 | All <b>Nodes</b> on this <b>node</b> address                       |
| FF02:0:0:0:0:0:1 | All <b>Nodes</b> on this <b>link</b> address                       |
| FF01:0:0:0:0:0:2 | All <b>Routers</b> on this <b>node</b> address                     |
| FF02:0:0:0:0:0:2 | All <b>Router</b> address on this <b>link</b>                      |

|                     |  |
|---------------------|--|
| FF02:0:0:0:0:3      | unassigned   |
| FF02:0:0:0:0:1:1    | Link Name  |
| FF02:0:0:0:0:1:2    | All DHCP agents on this link                         |
| FF02:0:0:0:0:1:3    | All DHCP servers on this link                        |
| FF02:0:0:0:0:1:4    | All DHCP relays on this link                         |
| FF05:0:0:0:0:1:2    | All DHCP agents at this site                         |
| FF05:0:0:0:0:1:3    | All DHCP servers at this site                        |
| FF05:0:0:0:0:1:4    | All DHCP relays at this site                         |
| FF0X:0:0:0:0:2:7FFE | Session Announcement Protocol (SAP) v1 Announcements |

## Multimedia conferences:

|                        |                        |
|------------------------|------------------------|
| FF0X:0:0:0:0:2:8000 .. | multimedia conferences |
| FF0X:0:0:0:0:2:FFFF    |                        |

X=2 -- this link; X=5 -- this site

Use SAP to announce the conference - repeatedly until the end of the conference.



# Prefix for IPv6 documentation

The IPv6 unicast address prefix `2001:DB8::/32` is reserved for use in examples for books, RFCs, ... [8].

Note that this is a **non-routable** range - to help avoid problems!

# Anycast

Sending a packet to a generic address to get a specific service from the “nearest” instance. This puts the burden of determining which instance to deliver it to on the routing system.

Requires defining a router entry for each anycast address.

Subnet Anycast Address:

|                           |                   |
|---------------------------|-------------------|
| Subnet prefix<br>(n bits) | 0<br>(128-n bits) |
|---------------------------|-------------------|

Thus the host ID of zero is treated as the subnet.

# IPv6 Routing

- all standard routing protocols
- routing extensions
  - **Provider Selection**
  - **Host Mobility** (route to current location)
  - **Auto-Readdressing** (route to new address)

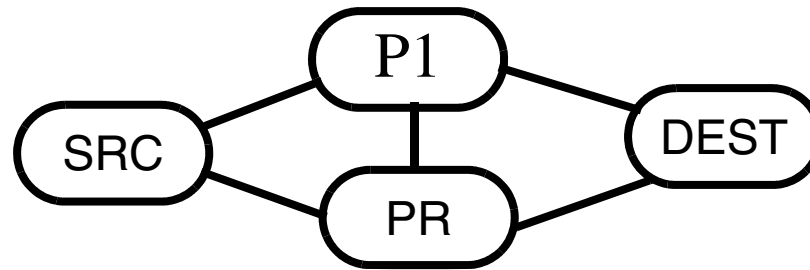

Figure 1: IPv6 Routing Option: provider specifies: SRC, PR, P1, Dest  
reply: Dest, PR, P1, SRC

# Routing header

| Next Header<br>(8 bits)  | Header Ext Length<br>(8 bits) | Routing Type=0<br>(8 bits) | Segments Left<br>(8 bits) |
|--------------------------|-------------------------------|----------------------------|---------------------------|
| reserved<br>(32 bits)    |                               |                            |                           |
| address[1]<br>(128 bits) |                               |                            |                           |
| address[2]               |                               |                            |                           |
| ...                      |                               |                            |                           |
| address[n]               |                               |                            |                           |

Next Header identifies the next header in the chain of headers.

Header Ext. Length. - number of 64 bit words (not including the first 64 bits).

Routing type=0, is the generic routing header which all IPv6 implementations must support.

Number of Segments is the number of segments left in the list (between 0 and 23).

# Fragment header

|                         |                      |                              |                      |              |
|-------------------------|----------------------|------------------------------|----------------------|--------------|
| Next Header<br>(8 bits) | Reserved<br>(8 bits) | Fragment offset<br>(13 bits) | RESERVED<br>(2 bits) | M<br>(1 bit) |
| Identification          |                      |                              |                      |              |

Fragment offset - in units of 64 bit words, the field is the most significant 13 bits of a 16 bit words.

M == More fragment bit, set in all but the last fragment

Identification - a 32 bit number

# Destination Options header

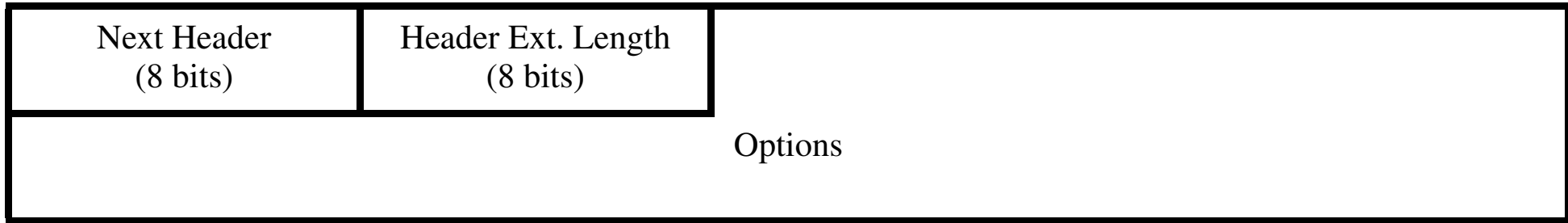

Each options field is encoded as:

Option Type (8 bits)      Option Data Length (8 bits)      Option Data (n octets)

The option type:

Action (2 bits)      C (1 bit)      Number (6 bits)

Action tells what action must be taken if the processing nodes does **not** recognize the option.

| Bits | Action   |
|------|--|
| 00   | Skip over this option  |
| 01   | Discard packet silently (i.e., without sending an ICMP report)                       |
| 10   | Discard packet and send an ICMP report - even if destination is multicast            |
| 11   | Discard packet and send an ICMP report - only if destination is <b>not</b> multicast |

C == change en route bit -- indicates that this option may be changed by

intermediate relays on the way to the destination

Currently only two options are defined:

Pad1 == a null byte - for use in padding to a 64-bit boundary; note it does not have a null option length field after it - as it is the whole field

PadN - the length field says how many null bytes are needed to file to a 64-bit boundary.

# Hop-by-Hop Options header

Same basic format as Destination option header, but the hop-by-hop header will be processed at each hop along the way.

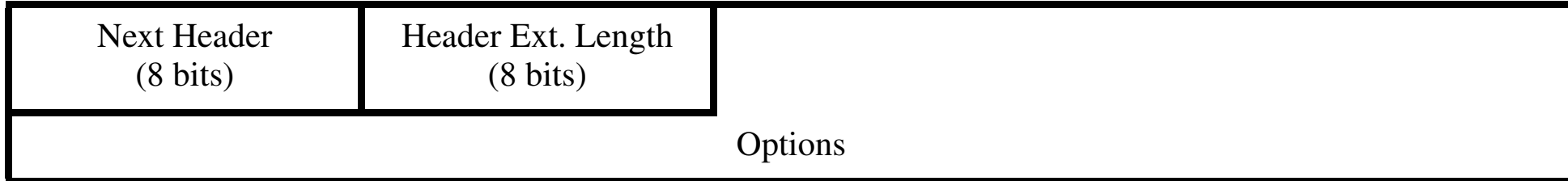

Each options field is encoded as:



Currently three options are defined: Pad1, PadN, and

- Jumbo payload option (option type =194) - the option Data Length is 4 and is followed by a 32 bit Jumbo Payload Length value.

See RFC 2113: Router Alert Option [9].



# Security

- Header Authentication with signatures
  - Must have support for Message Digest 5 (MD5) algorithm [11]
- RFC 1810 [12] examines MD5 performance
- Packet Encapsulation with e.g., DES

For more information see Chapter 5 of *IPv6*, 2nd edition, by Christian Huitema.

# IPSEC IPv6 implementation

The US Naval Research Lab (NRL) IPv6/IPsec Software Distribution

- a reference implementation of IPv6 and IP Security for the 4.4BSD-Lite networking software.
- Freely distributable (subject to U.S. export controls) and usable for commercial and non-commercial purposes (you must adhere to the NRL and UC Berkeley license terms) see also:

<http://web.mit.edu/network/isakmp>

- DOD ISAKMP Distribution
- Cisco's ISAKMP Distribution
- NRL's IPv6 + IPSEC Alpha 7.1 Distribution (Dec '98)
- Portland State University's Mobile IP with IPSEC for FreeBSD 2.2.1.

See also the list of IPv6 implementations at:

<http://playground.sun.com/pub/ipng/html/ipng-implementations.html>

# IPv6 ICMP [13]

| Type<br>(8 bits) | Code<br>(8 bits) | Checksum<br>(16 bits) |
|------------------|------------------|-----------------------|
| Message Body     |                  |                       |

## Currently defined ICMP Types

| Type | Purpose                    |
|------|----------------------------|
| 1    | Destination Unreachable    |
| 2    | Packet too big             |
| 3    | Time exceeded              |
| 4    | Parameter problem          |
| 128  | Echo Request               |
| 129  | Echo Reply                 |
| 130  | Group Membership Query     |
| 131  | Group Membership Report    |
| 132  | Group Membership Reduction |
| 133  | Router Solicitation        |
| 134  | Router Advertisement       |
| 135  | Neighbor Solicitation      |
| 136  | Neighbor Advertisement     |
| 137  | Redirect                   |

# IPv6 ICMP Error Messages

Type: 1, 2, 3, or 4:

| Type  | Code | Checksum |
|---|------|----------|
| Parameter   |      |          |
| As much of invoking packet as will fit - without the overall ICMP packet exceeding 576 octets |      |          |

For type 1 the code reveals the reason for discarding the datagram

# IPv6 ICMP Echo Request/Reply (PING)

Type: Echo Request = 128, Echo Reply = 129

|            |      |                 |
|------------|------|-----------------|
| Type       | Code | Checksum        |
| Identifier |      | Sequence number |
| Data       |      |                 |

# IPv6 ICMP and groups

Three group membership messages (type 130, 131, and 132):

| Type                   | Code | Checksum |
|------------------------|------|----------|
| Maximum Response Delay |      | Unused   |
| Multicast Address      |      |          |

The Group Membership Reduction is used when a node leaves group.

Reports are always sent to the same group address that is reported.

Maximum response delay is the time in milliseconds that the responding report messages can be delayed. Responding stations are supposed to spread their responses uniformly over this range of delays (to prevent everyone from responding at once).

# Summary of IPv6 ICMP

- incorporates IPv4's **ARP** (via **neighbor solicitation and advertisement**) and **IGMP** (via **group membership messages**)
- **RARP** is **dropped** since BOOTP provides the same functionality
- **dropped** IPv4's **Source Quench**
- added **Packet Too Big** message to simplify learning MTU size

For more information about ICMP see: RFC 2463 [13]

# DNS and IPv6

A new record type “AAAA” which contains a 128 bit address.

Just as for the “in-addr.arpa” domain used for converting Ipv4 addresses into names, IPv6 defines an “ipv6.int” domain:

thus the address 2001:0DB8:1:2:3:4:567:89ab is represented as:

b.a.9.8.7.6.5.0.4.0.0.0.3.0.0.0.2.0.0.0.1.0.0.0.8.b.d.0.1.0.0.2.IP6.INT

For further information see RFC 3596 [14].



# IPv6 Transition Mechanisms

- Incremental update and deployment
  - first step: dual stack hosts and routers
  - Encapsulation of IPv6 in IPv4 packets  $\Rightarrow$  tunnels
- Minimal upgrade dependencies (must first upgrade DNS)
- Easy addressing (upgraded routers can use IPv4 address)
- FreeBit Co., Ltd.'s Feel6 - secure IPv6 over IPv4[5], see slide 12 [79] and <http://start.feel6.jp/>
- See also [15]

# Why IPv6?

- solves Internet scaling problem
  - “eliminates” the problem of running out of addresses
  - allows route aggregation - which allows the size of the routing tables in the backbone routers to decrease
- flexible transition (interworks with IPv4)
- meets the needs of new markets
- new functionality
- real-time flows
- provider selection
- host mobility
- end-to-end security
- auto-configuration - chapter 4, “Plug and Play” in *IPv6*, 2nd edition, by Christian Huitema - this a **very major** advantage of IPv6. See also [21]

# IPv6 networks

**6Bone** - <http://www.6bone.net/> a testbed for deployment of IPv6

- Note the phase out of the 3FFE::- prefix will be returned to the unassigned address pool on 6 June 2006 [16].

**vBNS** - <http://www.vbns.net>

**6NET** <http://www.6net.org/> - project co-funded by European Commission

**Euro6IX**: European IPv6 Internet Exchanges Backbone

<http://www.euro6ix.org/main/index.php> - project co-funded by European Commission

For some issues concerning IPv6 deployment see [23]

# RIR assignments of IPv6 addresses

Total number of allocated IPv6 prefixes per RIR on 13/05/2005 [25]

| RIR      | Size in /48s  | Count |
|----------|---------------|-------|
| APNIC    | 416,579,590   | 376   |
| ARIN     | 9,699,375     | 195   |
| LACNIC   | 1,048,577     | 17    |
| RIPE NCC | 1,091,723,264 | 635   |
| Total:   | 1,519,050,806 | 1,223 |

# If things are to be connected they need to be addressable $\Rightarrow$ IPv6

In the near term an important enabler is IPv6.

The EU Commission points to two objectives for adoption of IPv6[27]:

- The IPv4 address space is being exhausted
- The vast IPv6 “a platform for innovation in IP based services and applications”

A problem is that IPv6 has been in development and gradual roll-out since the 1990s!

# Migration to IPv6

A set of priorities for the “migrating to the new Internet protocol IPv6” were published by the EU Commission in 2002 [28]:

- 1 “An increased support towards IPv6 in public networks and services,
- 2 The establishment and launch educational programmes on IPv6,
- 3 The adoption of IPv6 through awareness raising campaigns,
- 4 The continued stimulation of the Internet take-up across the European Union,
- 5 An increased support to IPv6 activities in the 6th Framework Programme,
- 6 The strengthening of the support towards the IPv6 enabling of national and European Research Networks,
- 7 An active contribution towards the promotion of IPv6 standards work,
- 8 The integration of IPv6 in all strategic plans concerning the use of new Internet services.”

# Where are ISPs?

“... There is evidence that less than half of the ISPs offer some kind of IPv6 interconnectivity. Only a few ISPs have a standard offer for IPv6 customer access service (mainly for business users) and provide IPv6 addresses.<sup>1</sup> The percentage of Autonomous Systems (typically ISPs and large end-users) that operate IPv6 is estimated at 2.5%.<sup>2</sup>

Accordingly, IPv6 traffic seems to be relatively low. Typically the IPv6/v4 ratio is less than 0.1% at Internet Exchange Points (of which about one in five supports IPv6).<sup>3</sup> However, this omits direct ISP to ISP traffic and IPv6 which is tunnelled and so appears at first glance to be still IPv4. Recent measurements suggest that this kind of traffic IPv6 which is "tunnelled" is growing.”[28]

---

1. <http://www.sixxs.net/faq/connectivity/?faq=ipv6transit>

<http://www.sixxs.net/faq/connectivity/?faq=ipv4native>

2. <http://bgp.he.net/ipv6-progress-report.cgi>

3. “Traffic analysis at Amsterdam Internet Exchange reveals for the first 10 months 2007 average daily IP traffic of 177 Gbs; of which IPv6 traffic is 47 Mbs, i.e. 0.03%.” <http://www.ripe.net/ripe/meetings/ripe-55/presentations/steenman-ipv6.pdf>

# Further information

See:

<http://www.ipv6.org/>

<http://www.ipv6forum.com/>

Measurements of dual stack IPv6 implementations: <http://mawi.wide.ad.jp/mawi/dualstack/>

See also: [3] and [4].



# Summary

This lecture we have discussed:

- IPv6

# References

- [1] S. Deering and R. Hinden, “Internet Protocol, Version 6 (IPv6) Specification”, IETF RFC 2460, December 1998  
<http://www.ietf.org/rfc/rfc2460.txt>
- [2] Jun Murai, “WIDE report”, 5th CAIDA-WIDE Workshop, Information Sciences Institute, Marina del Rey, CA, 15 March 2005  
<http://www.caida.org/projects/wide/0503/slides/murai.pdf>
- [3] Kenjiro Cho, “Measuring IPv6 Network Quality” (part 1), 5th CAIDA-WIDE Workshop, Information Sciences Institute, Marina del Rey, CA, 15 March 2005 <http://www.caida.org/projects/wide/0503/slides/kenjiro-1.pdf>
- [4] Kenjiro Cho, “Measuring IPv6 Network Quality” (part 2), *Internet Initiative Japan (IIJ)* / WIDE, 5th CAIDA-WIDE Workshop, Information Sciences Institute, Marina del Rey, CA, 15 March 2005  
<http://www.caida.org/projects/wide/0503/slides/kenjiro-2.pdf>
- [5] “Trying Out for Yourself: Smooth use of IPv6 from IPv4 by Feel6 Farm”, IPv6Style, NTT Communications, 7 March 2003  
<http://www.ipv6style.jp/en/tryout/20030307/index.shtml>
- [6] S. McCanne, V. Jacobson, M. and Vetterli, “Receiver-driven Layered Multicast”, ACM SIGCOMM, August 1996, Stanford, CA, pp. 117-130. <ftp://ftp.ee.lbl.gov/papers/mccanne-sigcomm96.ps.gz>
- [7] D. Borman, S. Deering, and R. Hinden, “IPv6 Jumbograms”, IETF RFC 2675 August 1999  
<http://www.ietf.org/rfc/rfc2675.txt>
- [8] G. Huston, A. Lord, and P. Smith, “IPv6 Address Prefix Reserved for Documentation”, IETF RFC 3849, July 2004  
<http://www.ietf.org/rfc/rfc3849.txt>
- [9] Dave Katz, “IPv6 Router Alert Option”, IETF RFC 2113, February 1997 <http://www.ietf.org/rfc/rfc2113.txt>
- [10] R. Gilligan, S. Thomson, J. Bound, and W. Stevens, “Basic Socket Interface Extensions for IPv6”, IETF RFC 2133, April 1997  
<http://www.ietf.org/rfc/rfc2133.txt>
- [11] R. Rivest, “The MD5 Message-Digest Algorithm”, IETF RFC 1321, April 1992 <http://www.ietf.org/rfc/rfc1321.txt>
- [12] J. Touch, “Report on MD5 Performance”, IETF RFC 1810, June 1995 <http://www.ietf.org/rfc/rfc1810.txt>

- [13] A. Conta and S. Deering, “Internet Control Message Protocol (ICMPv6) for the Internet Protocol Version 6 (IPv6) Specification”, IETF RFC 2463, December 1998 <http://www.ietf.org/rfc/rfc2463.txt>
- [14] S. Thomson, C. Huitema, V. Ksinant, and M. Souissi, “DNS Extensions to Support IP Version 6”, IETF RFC 3596, October 2003
- [15] C. Huitema, R. Austein, S. Satapati, and R. van der Pol, “Unmanaged Networks IPv6 Transition Scenarios”, IETF RFC 3750 , April 2004 <http://www.ietf.org/rfc/rfc3750.txt>
- [16] R. Fink and R. Hinden, “6bone (IPv6 Testing Address Allocation) Phaseout”, IETF RFC 3701, March 2004 <http://www.ietf.org/rfc/rfc3701.txt>
- [17] R. Hinden and S. Deering, “Internet Protocol Version 6 (IPv6) Addressing Architecture”, IETF RFC 3513, April 2003 <http://www.ietf.org/rfc/rfc3513.txt>
- [18] R. Hinden, S. Deering, and E. Nordmark, “IPv6 Global Unicast Address Format”, IETF RFC 3587, August 2003 <http://www.ietf.org/rfc/rfc3587.txt>
- [19] APNIC, ARIN, and RIPE NCC, "IPv6 Address Allocation and Assignment Policy", Document ID: ripe-267, January 22, 2003 <http://www.ripe.net/ripe/docs/ipv6policy.html>
- [20] IAB, “IAB/IESG Recommendations on IPv6 Address Allocations to Sites”, IETF RFC 3177, September 2001 <http://www.ietf.org/rfc/rfc3177.txt>
- [21] S. Thomson and T. Narten, “IPv6 Stateless Address Autoconfiguration”, IETF RFC 2462, December 1998
- [22] Toshiyuki Hosaka, “IPv6 Address Allocation and Policy: PART1 IPv6 Address Basics”, Tech Tutorials, IPv6Style, NTT Communications, 18 November 2004 <http://www.ipv6style.jp/en/tech/20041117/index.shtml>
- [23] Cisco, “IPv6 Deployment Strategies”, 23 December 2002 , [http://www.cisco.com/univercd/cc/td/doc/cisintwk/intsolns/ipv6\\_sol/ipv6dswp.htm](http://www.cisco.com/univercd/cc/td/doc/cisintwk/intsolns/ipv6_sol/ipv6dswp.htm)
- [24] Gert Döring, “Impressions:An overview of the global IPv6 routing table”, RIPE 50, Stockholm, SE, 3 May 2005, <http://www.space.net/~gert/RIPE/R50-v6-table.pdf>
- [25] RIPE, “Total number of allocated IPv6 prefixes per RIR on 13/05/2005”, web page accessed 2005.05.14 <http://www.ripe.net/rs/ipv6/stats/index.html>

- [26] J. Rajahalme, A. Conta, B. Carpenter, and S. Deering. “IPv6 Flow Label Specification”, IETF RFC 3697, March 2004  
<http://www.ietf.org/rfc/rfc3697.txt>
- [27] Advancing the Internet, Action Plan for the Deployment of Internet Protocol version 6 (Ipv6) In Europe, Communication from the Commission to the European Parliament, The Council, the European Economic and Social Committee and the Committee of the Regions, Brussels, 27 May 2008  
[http://ec.europa.eu/information\\_society/policy/ipv6/docs/european\\_day/communication\\_final\\_27052008\\_en.pdf](http://ec.europa.eu/information_society/policy/ipv6/docs/european_day/communication_final_27052008_en.pdf)
- [28] European Commission, Next Generation Internet priorities for action in migrating to the new Internet protocol IPv6, Communication from the Commission to the Council and the European Parliament, 21 February 2002

# IK1550 Internetworking/Internetteknik

## Spring 2010, Period 4

### Module 11: Mobile IP

Lecture notes of G. Q. Maguire Jr.



**KTH Information and  
Communication Technology**

© 2010 G.Q.Maguire Jr. .

All rights reserved. No part of this course may be reproduced, stored in a retrieval system, or transmitted, in any form or by any means, electronic, mechanical, photocopying, recording, or otherwise, without written permission of the author.

Last modified: 2010.03.21:17:36

# Outline

- Mobile IP

# Emerging Network Architecture

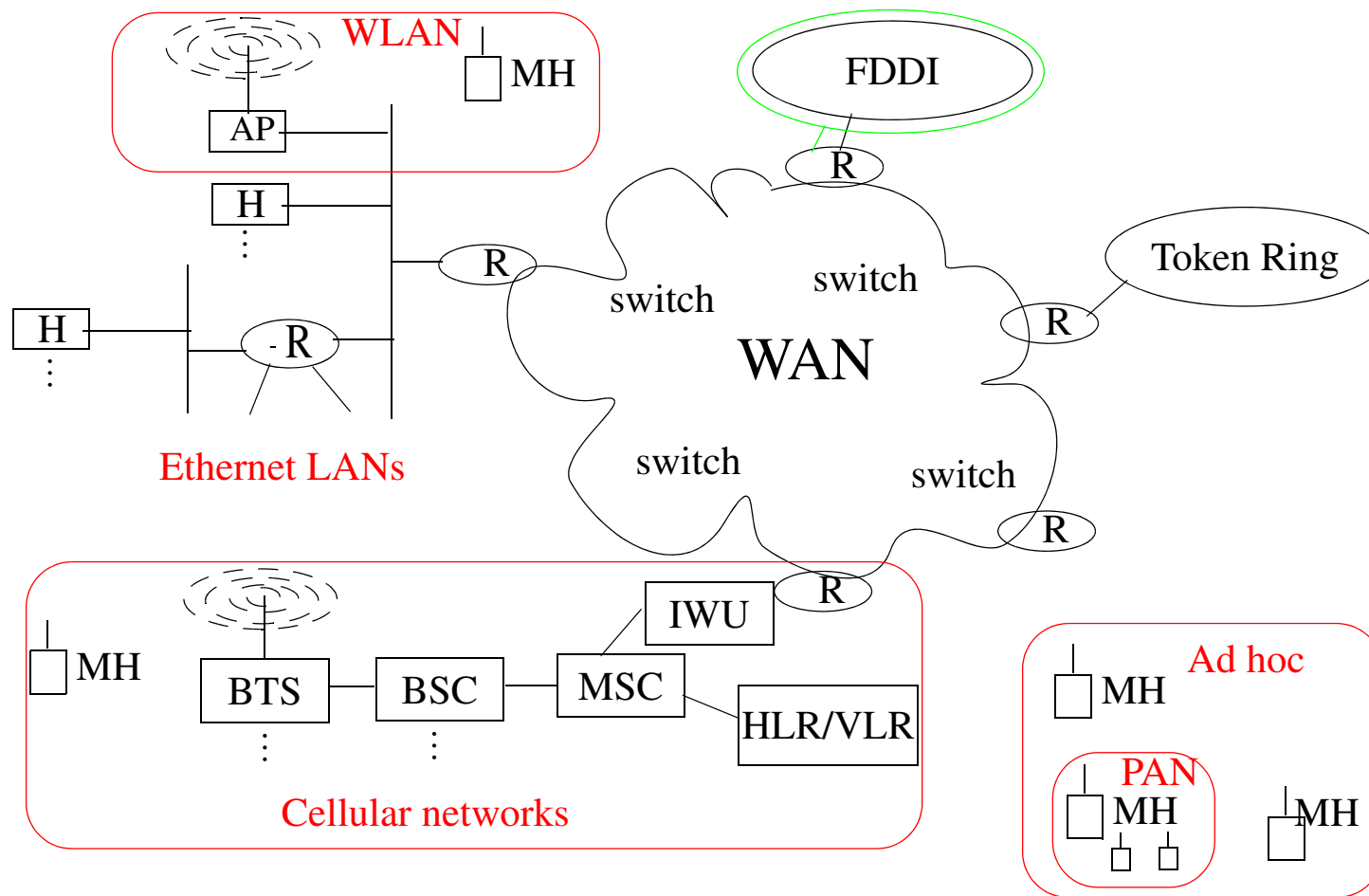

Figure 1: Mobility (WWAN, WLAN, PAN, ...) driving us towards Mobile Internet

# Mobility

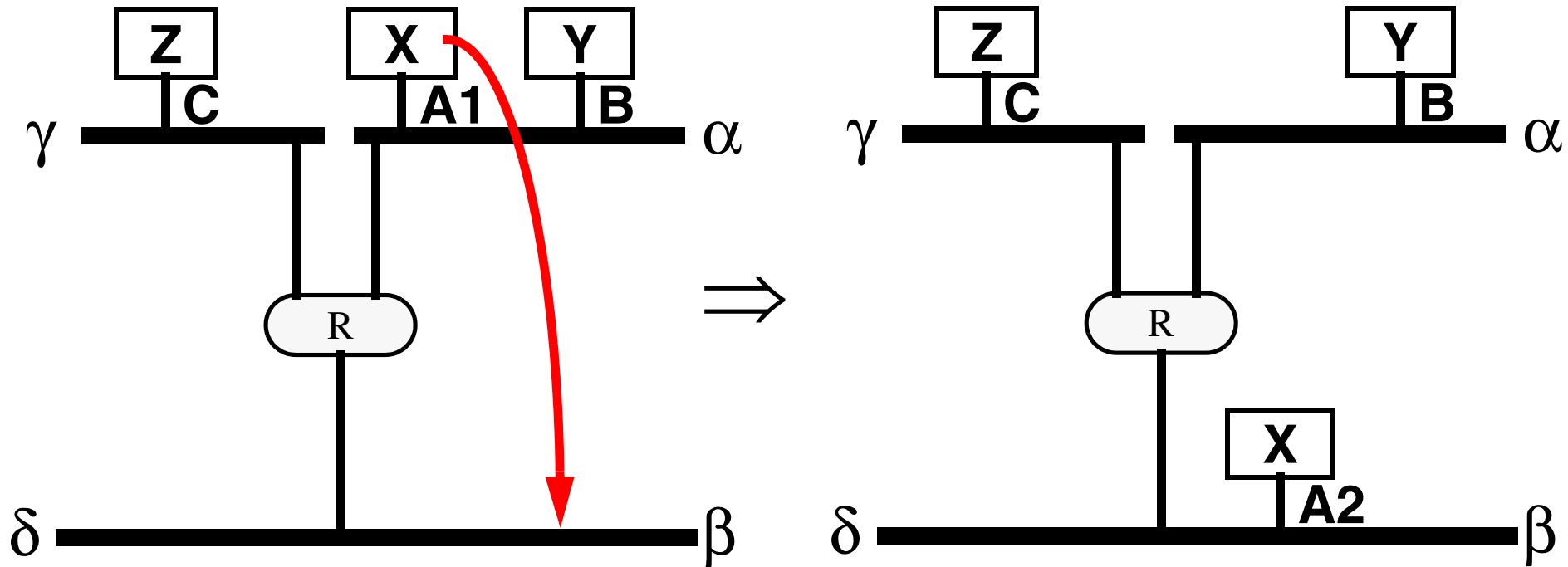

Figure 2. X disconnects from location A1 and reconnects at location A2

What is “X”? X represents the identity (ID) of the node<sup>1</sup>

- in an Ethernet it might be the MAC address, thus a node has a constant identity

While A1, A2, ... represent the network addresses of node X.

- IP network address consists of {Network, Host}, i.e.,  $A1 = \{\alpha | n\}$ , where n is unique on network  $\alpha$ .

1. Of course this really mixes the interface ID with the node ID - solution is a Network Access Identifier[1].



# Updating after a move

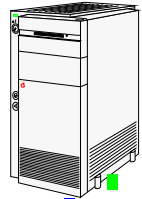

Host name: **“ccslab1.kth.se”**

Name Resolution: DNS, Host File, ...  $\Leftarrow$  DNS, Host File, ...

IP address **130.237.15.254**  $\Leftarrow$  **130.237.216.25**

HW address: **Ethernet MAC address** **08:00:2B:00:EE:0B**

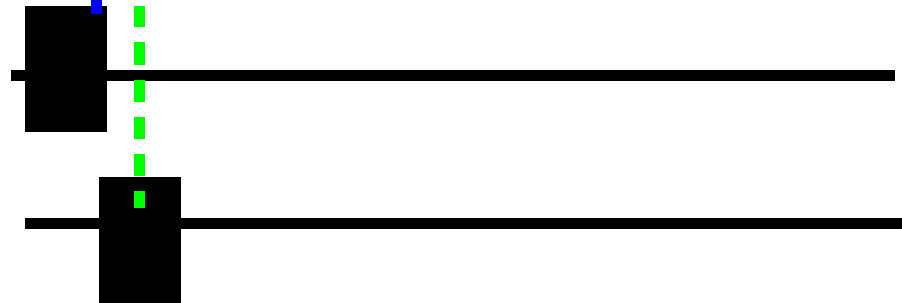
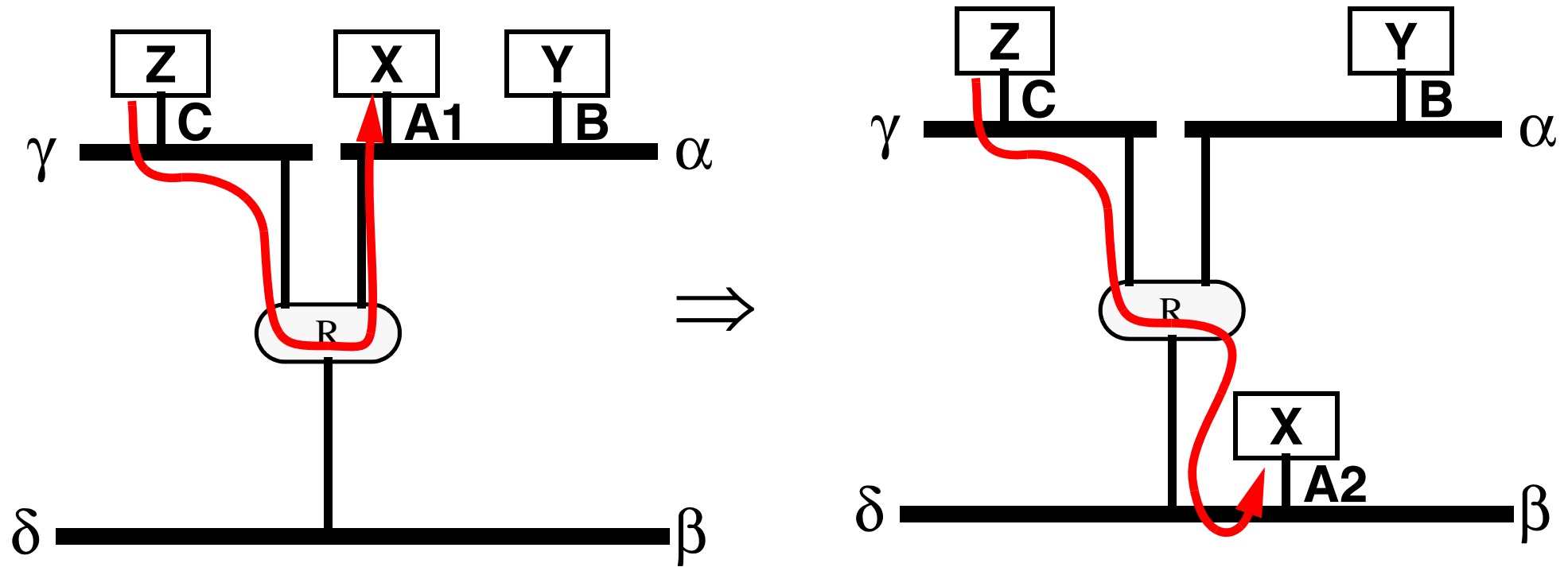

Figure 3: Must update IP address related mappings after a move  $\Rightarrow$  administrative nightmare

# Objectives of Mobile IP

- To provide mobility support for the Internet
- To enable node mobility: across changes in IP subnet
- Allow change in location without change of IP address
- Communication should be possible (even) while moving (if the interface/link supports it)
- TCP/IP connections should survive movement
- Active TCP and UDP port bindings should be maintained

## Communication from Z to X



**Figure 4. Z is communicating with X at A1 and wants to continue when X reconnects at location A2**

- This would require that router R send packets from Z to X over a new path (route).
  - ✗ But X now has a new network address, since it is on a different network ( $\beta$ ).

# How can Z continue to communication to X?

1. Just use bridging and change the forwarding table in the bridge (since the bridge uses MAC addresses)
  - ✗ But bridging does **not** **scale** well
2. The application could stop, then restart with the new address for X
  - ✗ This is unpleasant for the user - since they might have to do this very frequently and/or the programs may not tolerate this change - since they have too much state.
3. We could hide this change with a new layer of software
  - a. We could change the socket library
    - ✗ for example: we could do source routing - but, it turns out that this is not well supported by existing code in the OS<sup>1</sup> and in router (in addition, many the firewall routers at many sites filter out source routed packets!)
    - ✗ Would require changes in all systems (even the non-mobile systems - since both ends of the communication would have to change)
  - b. We could remap the addresses in the router
    - ✗ This would means doing host specific routing, which does not scale well
  - c. We could define a new Mobile-IP address
    - ✓ The implications of this will be described in the following material.

---

1. An informal experiment conducted by John Ioannidis as part of this Mobile\*IP research (and documented in an appendix of his thesis) indicted that almost all operating systems, of the time, did not correctly support source routing!

# Identification

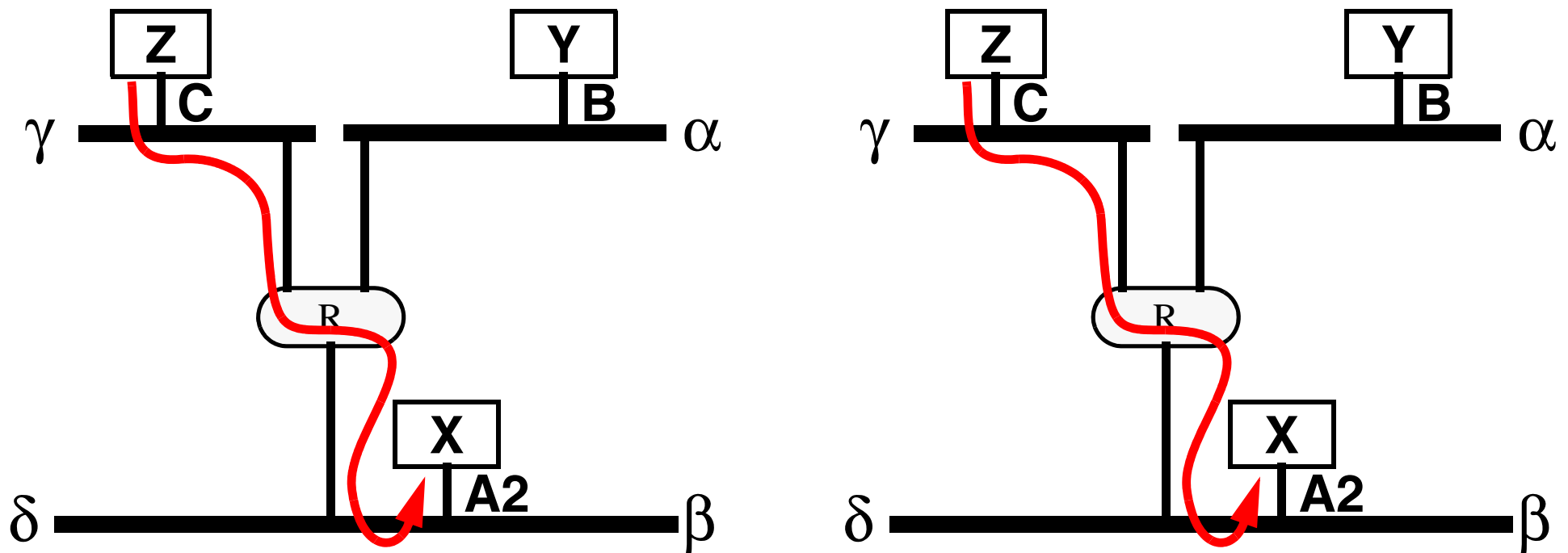

**Figure 5. How do we know it is the same X?**

**When X moves to its new location (A2)**

- Why should it get service?
- How do we know it is the same X? (Or even that it is X?)

# Establishing Identity

When a node arrives on a network it must identify itself

- mechanism: typically via a challenge response protocol
- Who should it identify itself to? Answer: The MSR  $\equiv$  1/2 Mobility Support Router

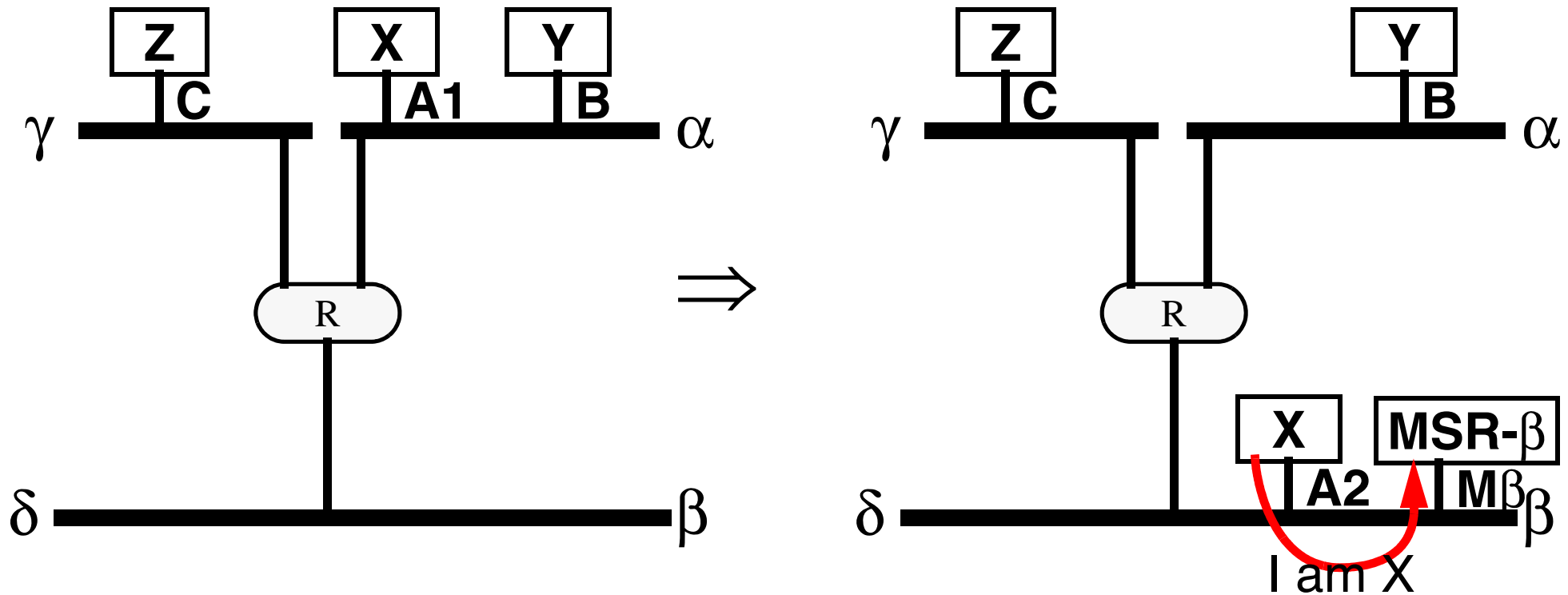

Figure 6. How do we know it is the same X?

# How did it know to send the “I am” message to the MSR?

- When a node arrives on a network it listens for broadcasts from MSRs

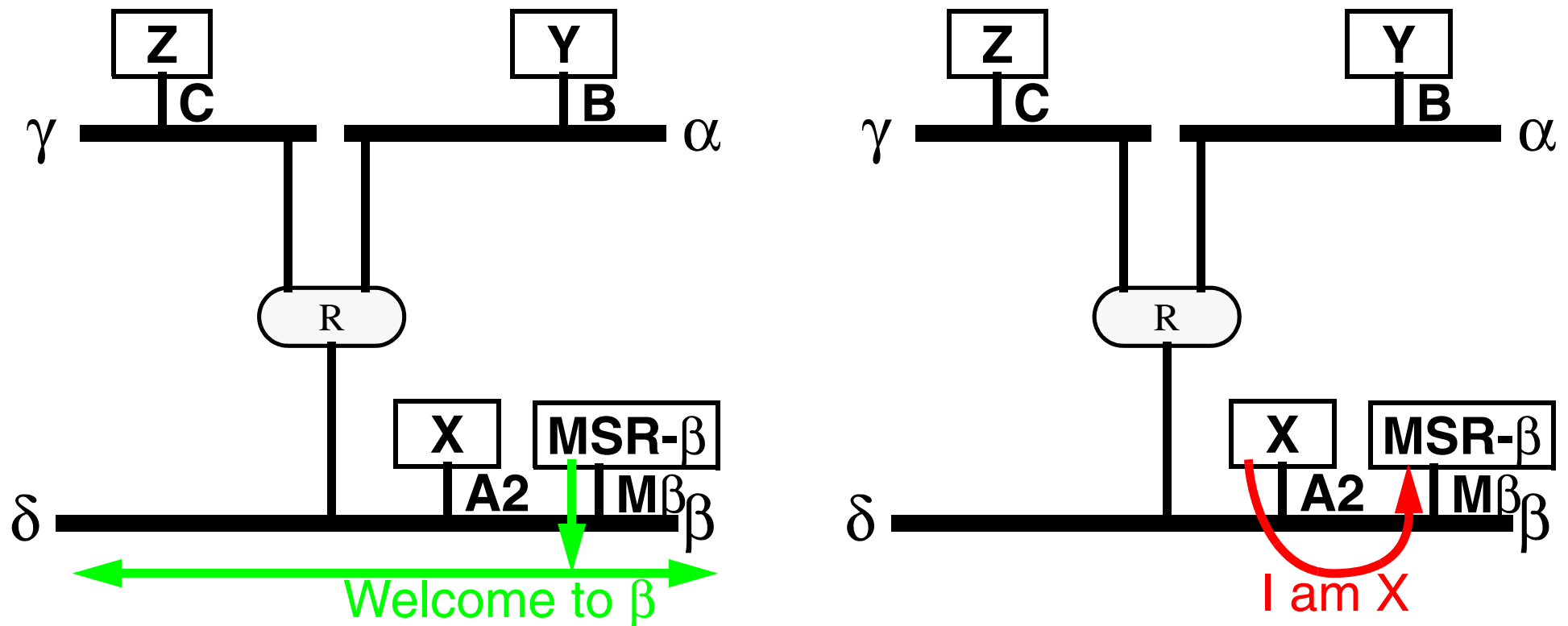

Figure 7. “Welcome (Greeting)” messages answered by “I am” messages  
These broadcast “Welcome” messages advertise:

- the presence of an MSR (and its MAC address)
- advertise one or more networks it provides connectivity to

# Could the MSR functionality be collocated with the router?

- When a node arrives on a network it listens for broadcasts from MSRs

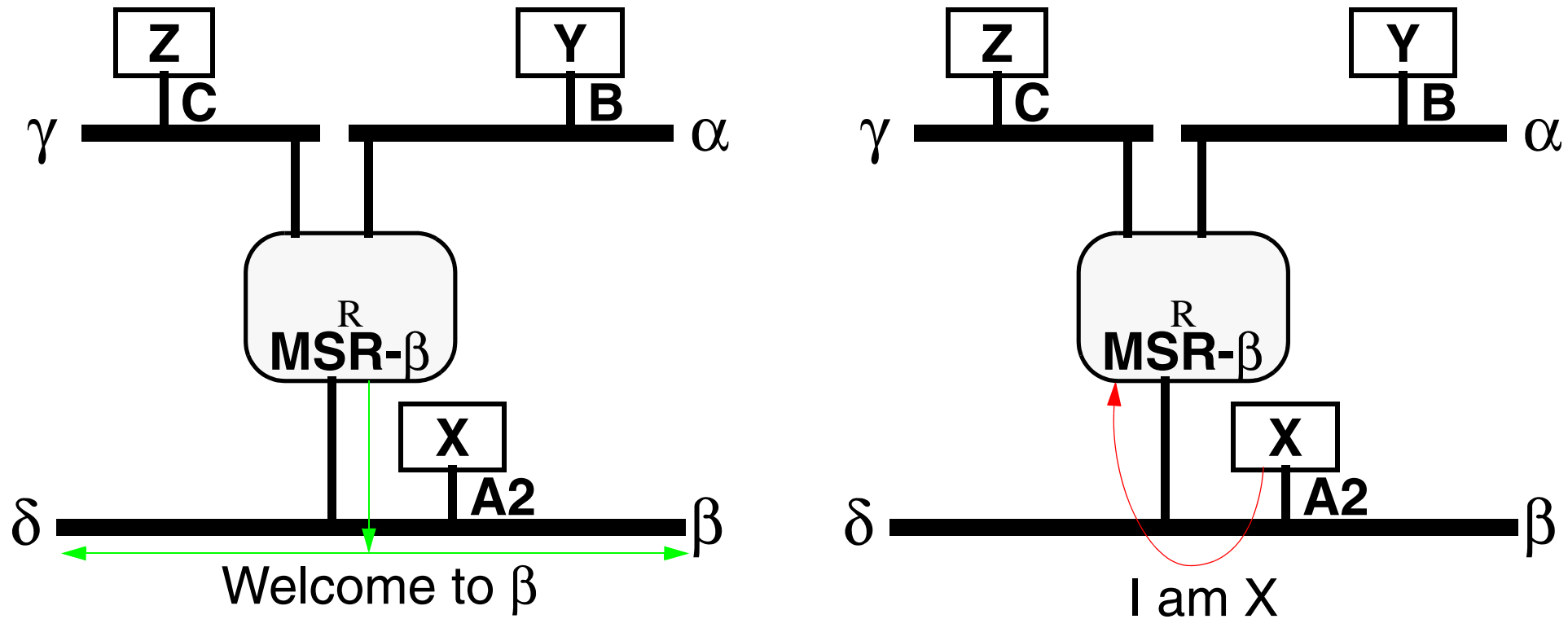

Figure 8. “Welcome (Greeting)” messages from router answered by “I am” messages

- ✘ Requires updating **all** of the routers on network segments which are going to support mobility to be updated.



# Getting Service

Once it's identity is known, the **policy** question must be asked: Should X get service?

The policy question and its answer may involve:

- roaming agreements (generally reciprocal agreements),
- current traffic loads,
- anticipated traffic loads,
- mobile user's priority/class/... ,
- ... .

The question of authentication, authorization, and accounting (AAA) for mobile users is addressed in [4].

See also IEEE 802.1x Port Based Network Access Control

<http://www.ieee802.org/1/pages/802.1x.html>

## Back to the original problem: Z wants to send a message to X

Initially X is located at A1 then it moves to A2.

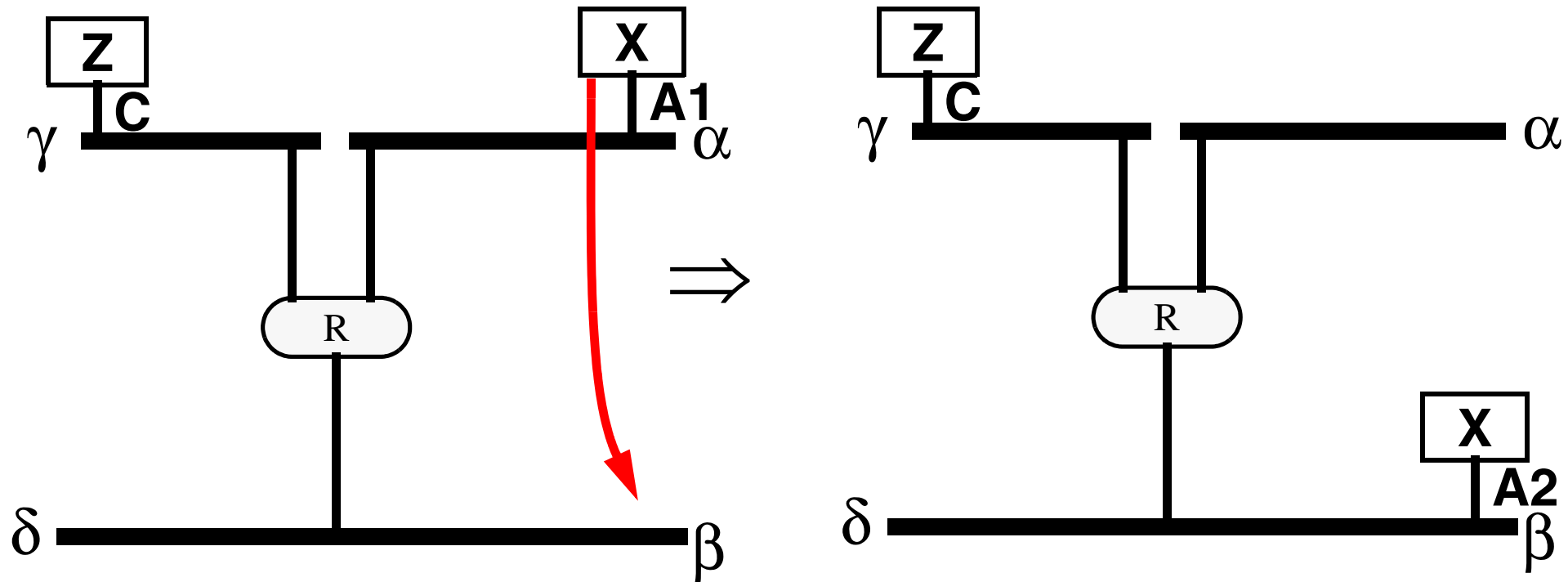
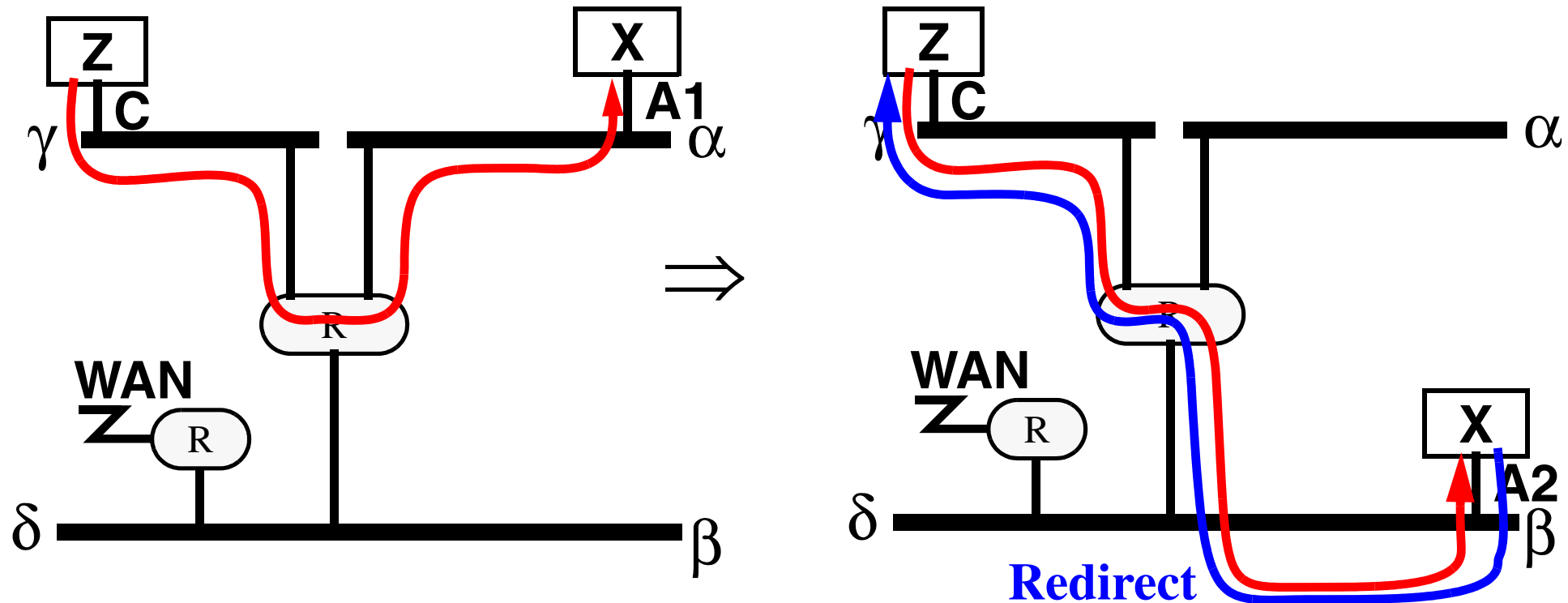

Figure 9. X moves from A1 to A2, Z not aware of Mobility

There are several alternatives.

## Alternative 1

Initially X is located at A1 then it moves to A2.

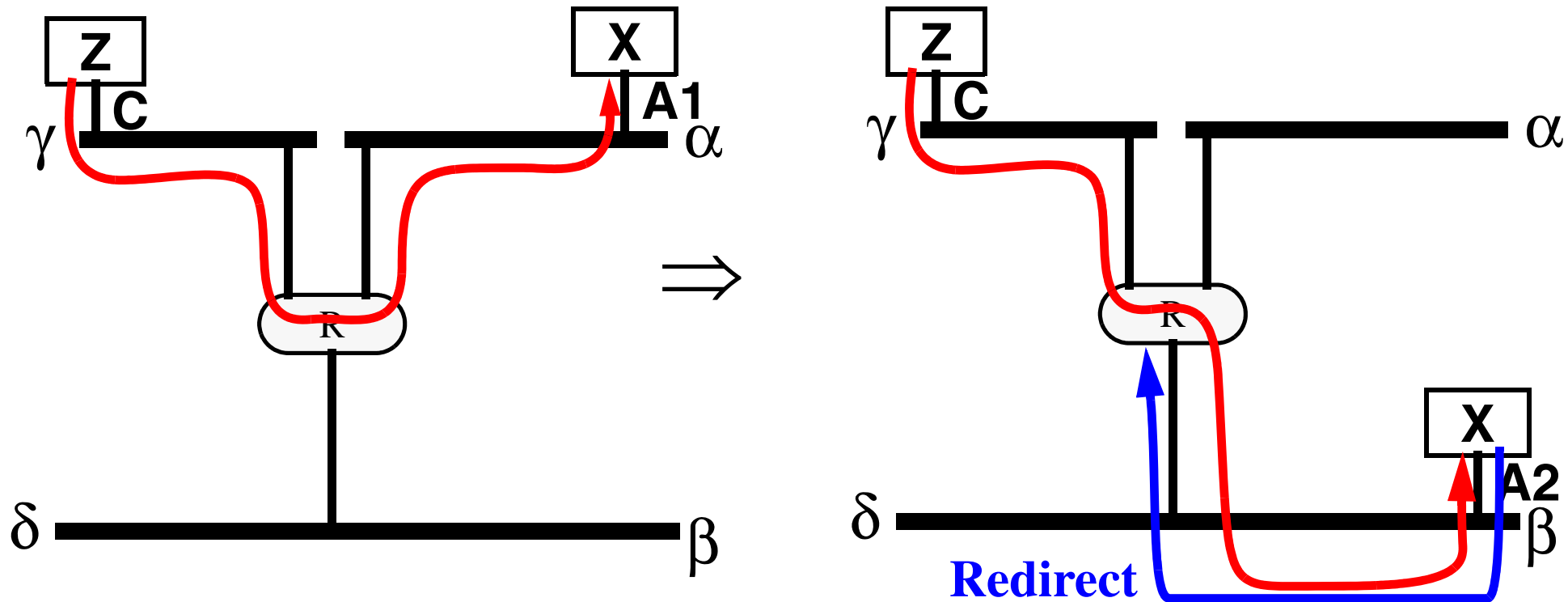

**Figure 10. X must send a redirect message to Z, to tell it it's new address A2.**

- ✗ Z must be aware of where X currently is.
- ✗ X must get a new local address A2 (How? perhaps DHCP)

## Alternative 2

Initially X is located at A1 then it moves to A2.

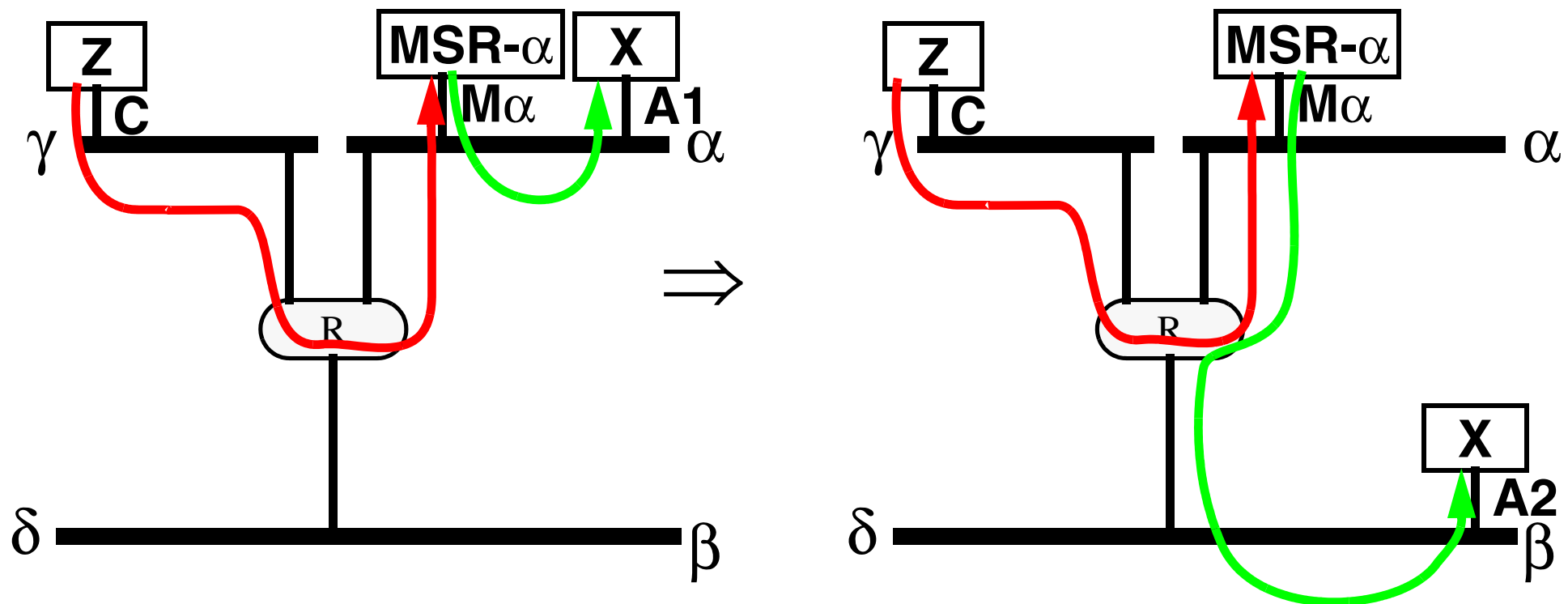

**Figure 11.** X must send a redirect message to the **Router**, to tell it it's new address A2 (rather than A1).

- ✗ Router must now perform host specific routing.
- ✗ X must get a new local address A2 (How? perhaps DHCP)

## Alternative 3

Initially X is located at A1 then it moves to A2.

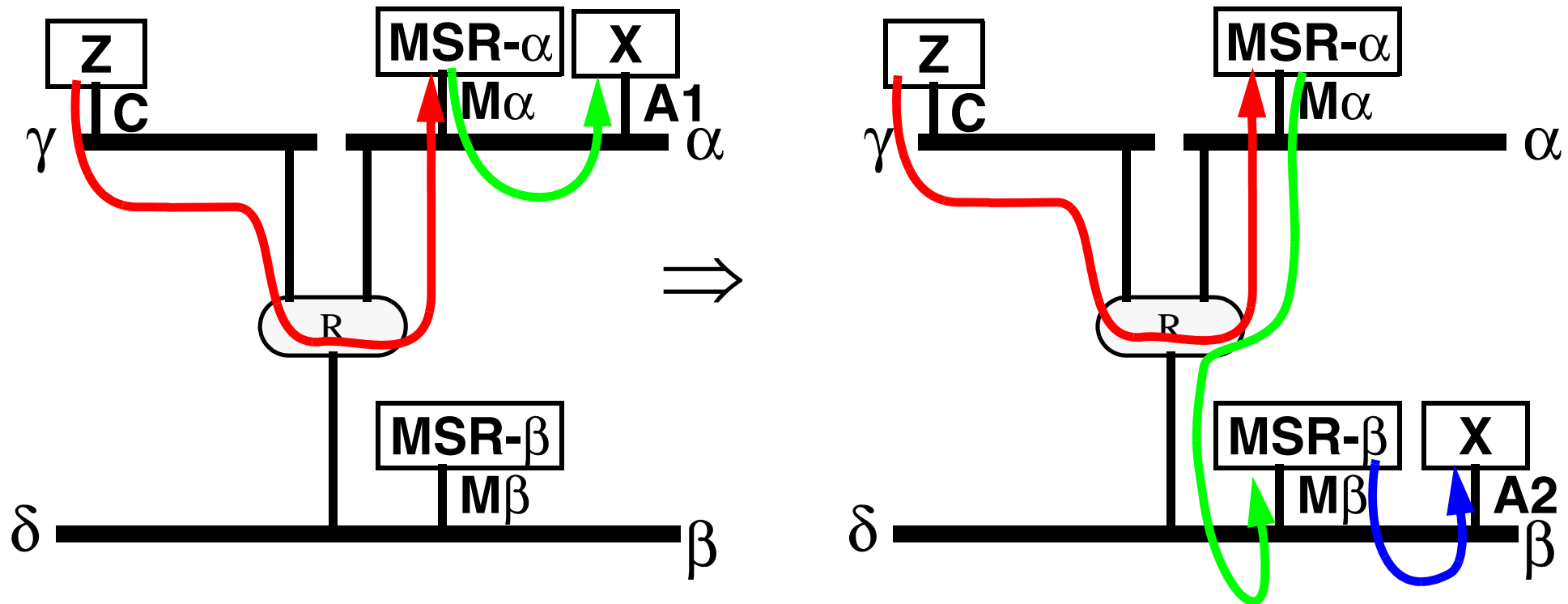

**Figure 12.** X must send a redirect message to a Mobility Support Router (**MSR- $\alpha$** ), to tell it it's new address A2 (rather than A1).

- ✗ **MSR- $\alpha$**  must now perform host specific routing.
- ✗ X must get a new local address A2 (How? perhaps DHCP)
- ✓ Z is now completely unaware of the move.
- ✓ Router R is now completely unaware of the move (except for twice the traffic over the link to/from  $\alpha$ ).

## Alternative 4

Initially X is located at A1 then it moves to A2.

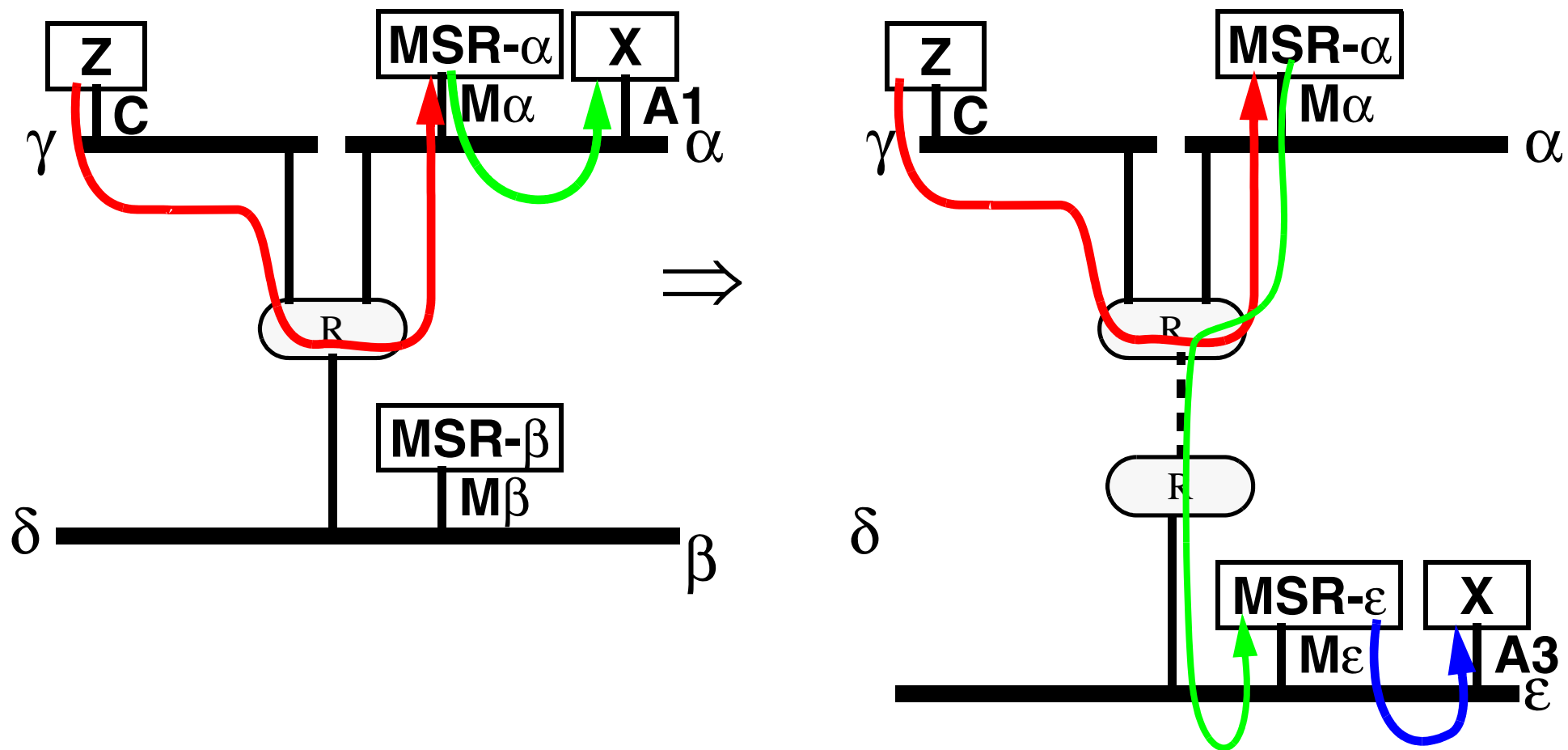

**Figure 13.** X sends a message to **MSR-β**, to get its new address A2 and says its old MSR was **MSR-α**.

- ✗ **MSR-α** must now perform host specific routing to **MSR-β** (which can provide the local address A2)
- ✓ Z is now completely unaware of the move - it always sends traffic to **MSR-α**.
- ✓ If X moves again, Z does not change where it sends traffic to & traffic need not go via **MSR-β** - it will go directly from **MSR-α** to the MSR responsible for the new segment.

## Alternative 4 continued

Initially X is located at A1 then it moves to A2 and then moves to A3.



**Figure 14.** X sends a message to MSR- $\epsilon$ , to get its new address A3 and says its old MSR was MSR- $\alpha$ .

- ✓ The traffic from MSR- $\alpha$  to MSR- $\beta$  or MSR- $\alpha$  to MSR- $\epsilon$  can be encapsulated, using for example IP in IP (written IP-IP) encapsulation. Thus none of the intervening routers needs know about mobility.

## How does Z know to send things to MSR- $\alpha$ ?

It does **not** know to do this!  $\Rightarrow$  Z simply sends the packet to the network address of X.

But what is the (real) network address of X?

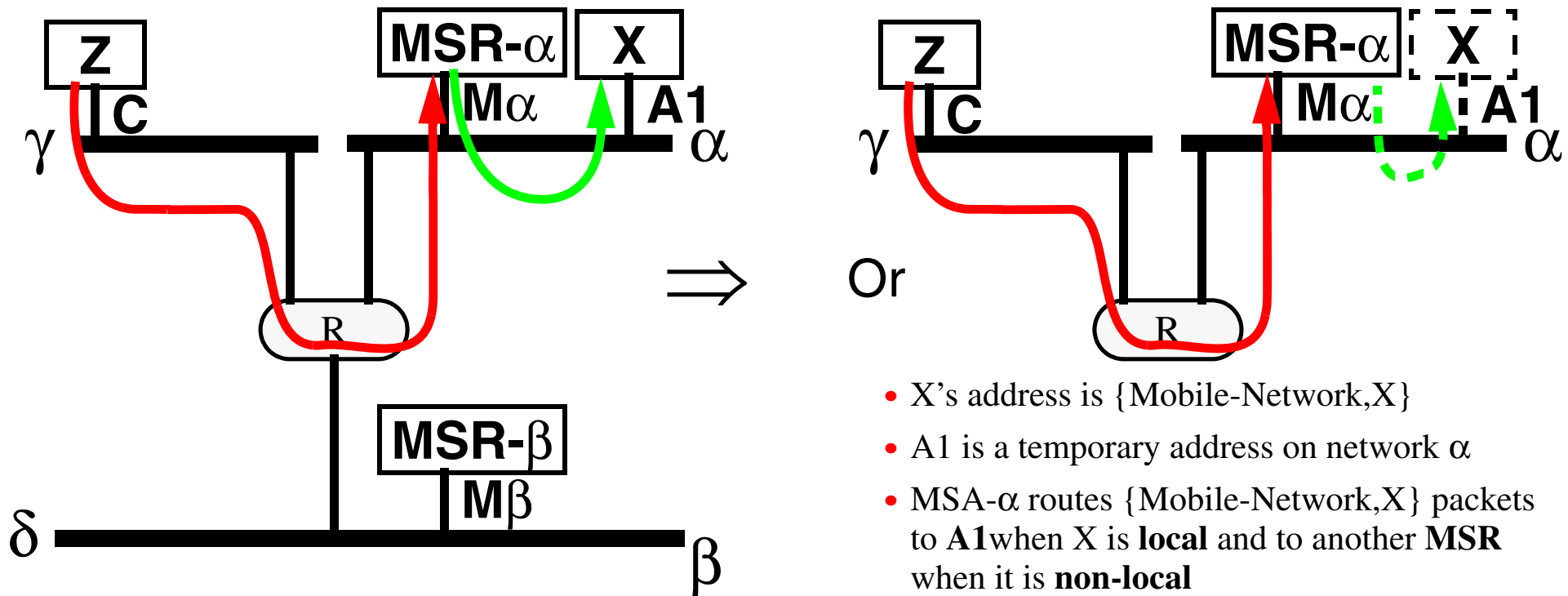

- X's address is {Mobile-Network, X}
- A1 is a temporary address on network  $\alpha$
- MSR- $\alpha$  routes {Mobile-Network, X} packets to A1 when X is **local** and to another MSR when it is **non-local**

**Figure 15. X's address - either on either an actual network or on a virtual network**

- ✓ In the first case ("actual" network addresses), either the hosts and routers have to be changed, or MSRs are necessary to intercept and reroute the packets.
- ✓ In the virtual network case, we use the MSRs to implement mobility for nodes on a virtual mobile network.



# What happens in the case of wireless networks?

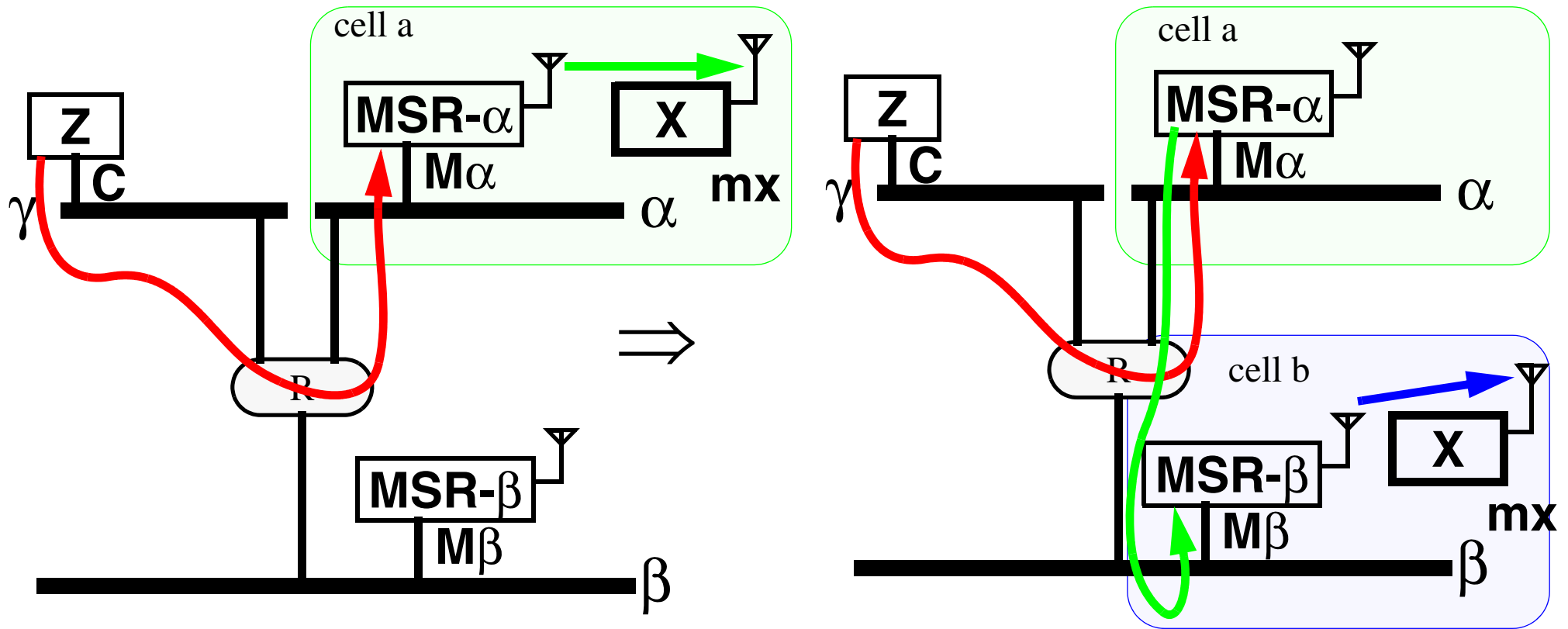

**Figure 16. X moves from the cell a to the cell b**

- The wireless cells are implemented by a basestation co-located with the MSR.
- Note that X retains it's mobile network address "mx".

# Wireless Local Area Networks

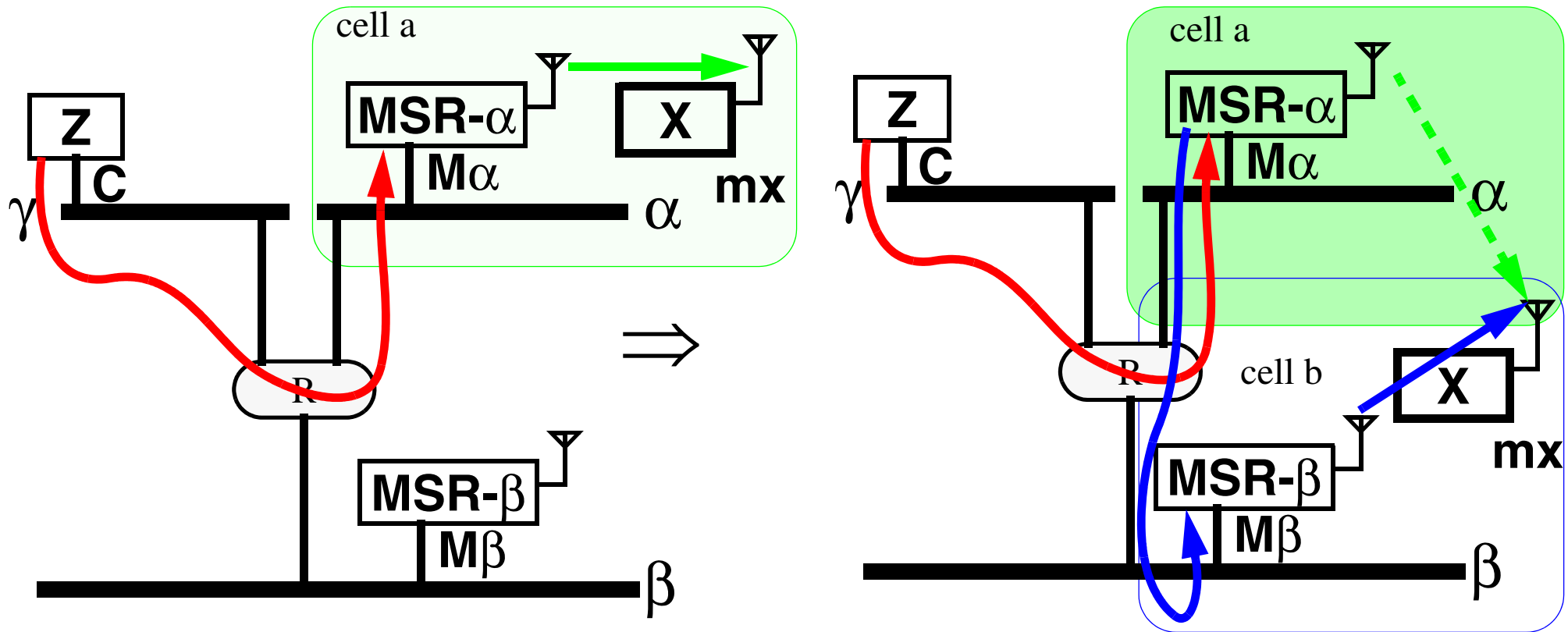

**Figure 17.** X moves from the cell a to the cell b, but is **still** reachable by cell a!

- Mobile network address "mx" is reachable from both MSR- $\alpha$  and MSR- $\beta$ .
- This could not occur in the wired case (unless there were multiple interfaces), since X would have to disconnect from network  $\alpha$  to connect to network  $\beta$ .
- If the cell size is small the movement between cells could be frequent (and caused by other events, such as a new user, a door moving, ...).

# Wireless WANs

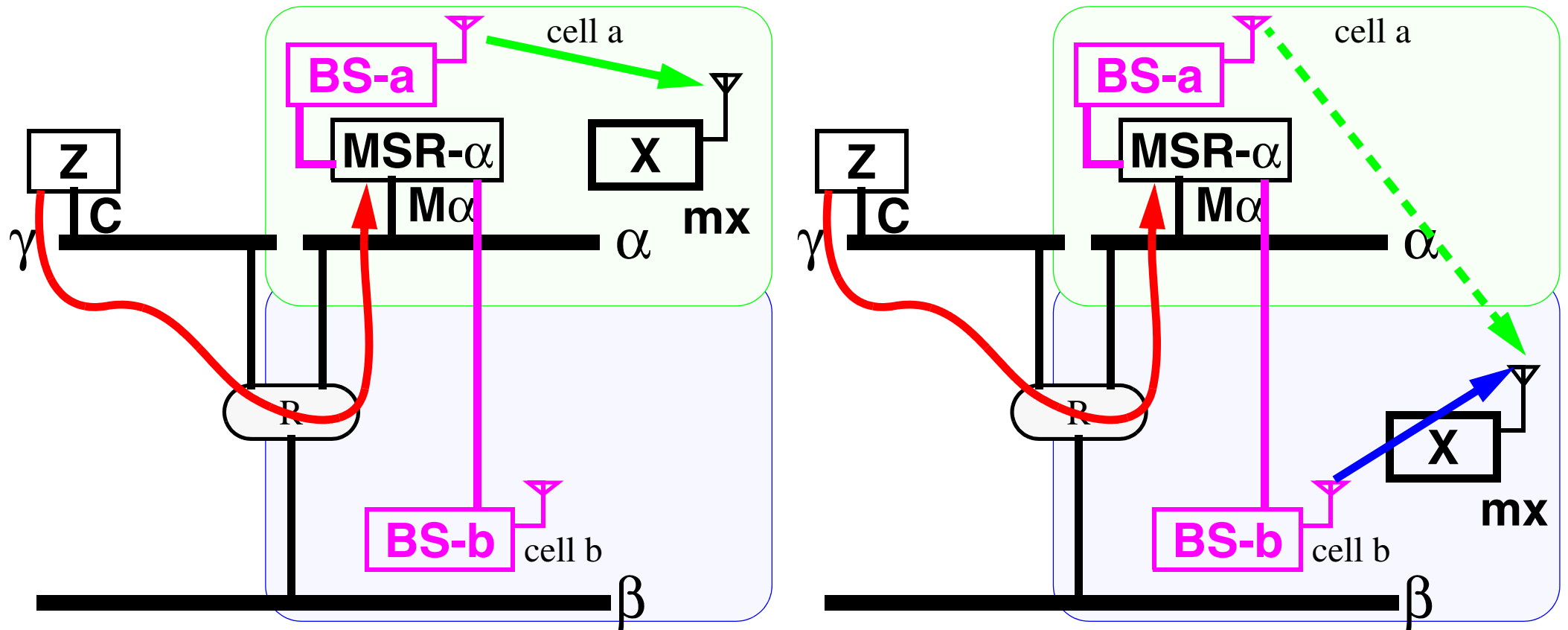
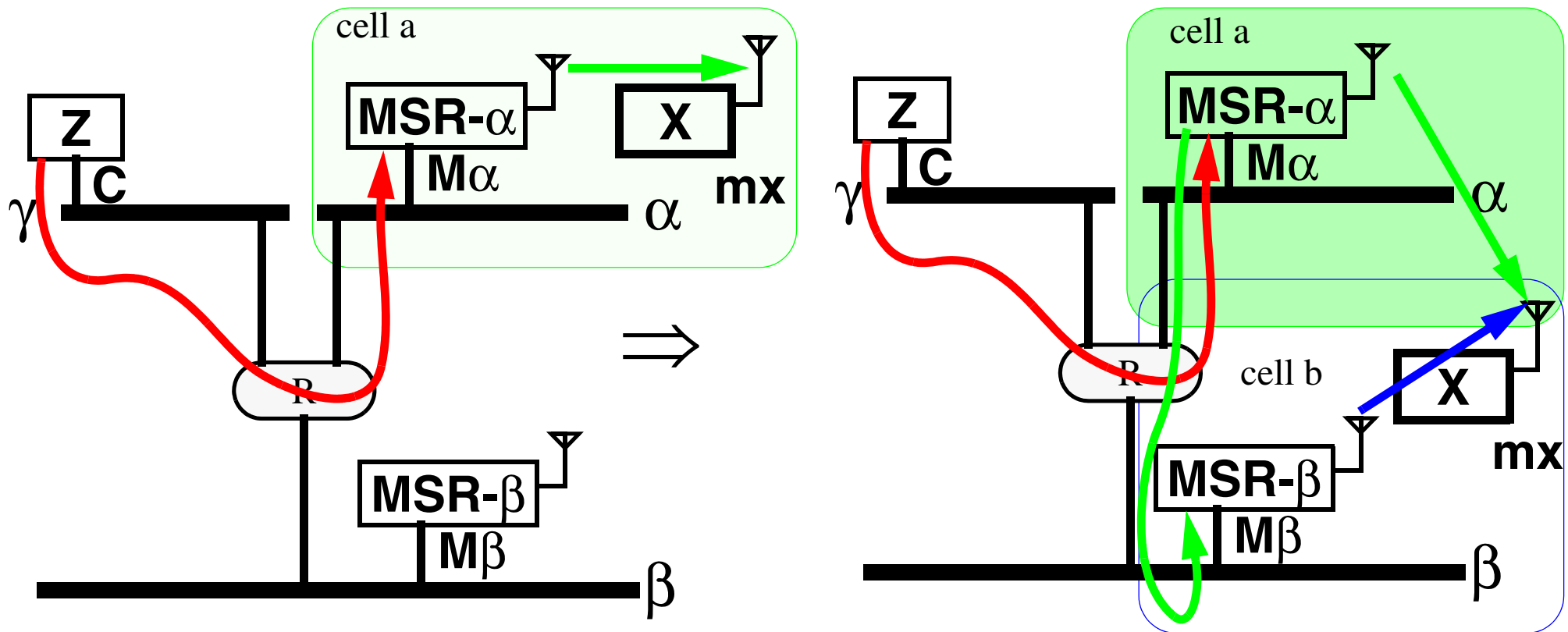

Figure 18. X moves from the cell a to the cell b, but may **still** reachable by cell a - but both cells are part of the same network

- Basestation-a, basestation-b, ... are all part of the **same network** and it is up to this network to select which cell a mobile is in and which basestation will be used to communicate with it.

# Simulcasting in Wireless Local Area Networks (WLANs)



**Figure 19. X is moving from the cell a to the cell b**

- Mobile network address “mx” is partially reachable from both MSR-α and MSR-β - thus we will send packets via both MSR-α and MSR-β. This insures:
  - ✓ Lower probability of packet loss (important if we must provide low latency and high reliability - such as is needed for voice and some other services)
  - ✗ increases traffic in both cells

# Mobile IP Standardization Effort

- Originally proposed by Columbia University, IBM, etc.
- Internet Engineering Task Force (IETF) Mobile-IP working group
  - <http://www.ietf.org/html.charters/mobileip-charter.html>

Mobile-IP standard status:

- RFCs:
  - Mobile-IPv4 (RFC 2002) IP Mobility Support; RFC 2003: IP Encapsulation within IP; RFC 2004, RFC 2005, RFC 2006, etc.
  - Mobile-IPv6
- Many Drafts related to v4 & v6:
  - Mobile IP NAI Extension, AAA Registration Keys for MIP, Registration Keys for Route Optimization, Mobile IP Challenge/Response Extensions, CDMA2000 Extension to MIP, Cellular IP, Regional Tunnel Management, Hierarchical MIP Handoffs, etc.

# A Mobile-IP(V4) Scenario

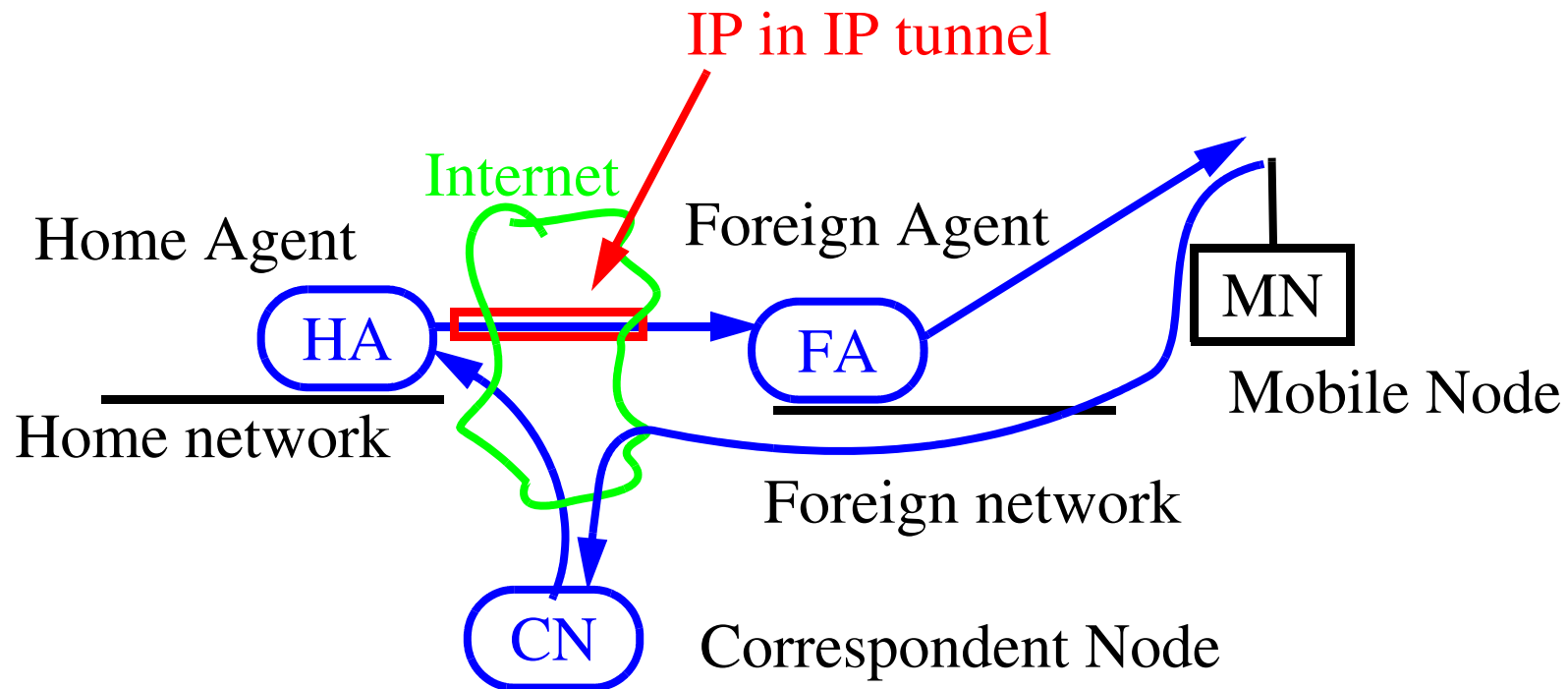

CN sends packet to MN's home network (because that is where its IP address is logically located), HA intercepts them and forwards them inside an IP-in-IP tunnel to the Care of Address (CoA) where the FA forwards them to the MN.

Traffic from the MN can go directly to the CN (**unless** there is **ingress** filtering)  
⇒ **triangle** routing

# A Mobile-IP(V6) Scenario

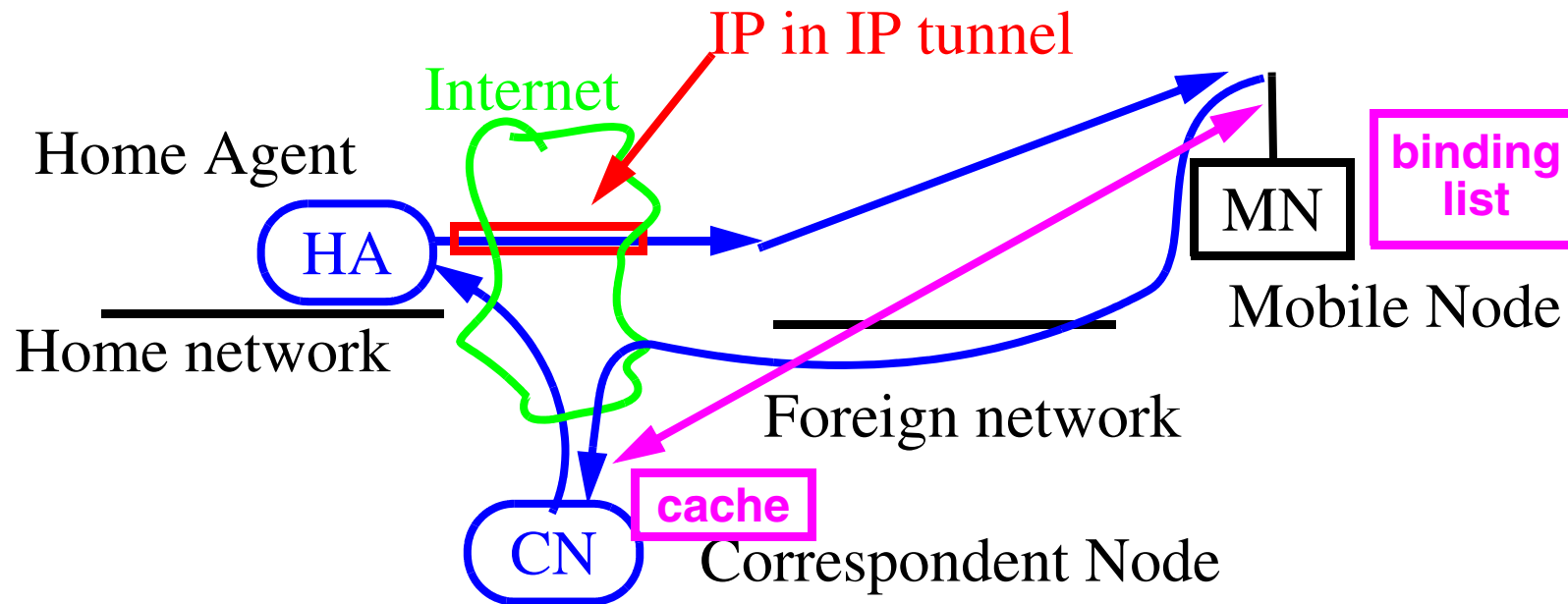

CN sends packet to MN's home network (because that is where its IP address is logically located), HA intercepts them and forwards them inside an IP-in-IP tunnel to the Care of Address (CoA) which is the MN's address in the foreign network.

However, the MN can tell the CN about its **current** address via a **binding update** (BU), now traffic can flow both ways directly between the CN and MN.

# IP-in-IP Encapsulation

In-in-IP vs. Minimal encapsulation - the major difference is the first puts the whole IP packet inside another, while the later tries to only put a minimal header inside along with the original data portion of the IP packet.

For details see

- IP Encapsulation within IP, RFC 2003 [2]
- Minimal Encapsulation within, IP RFC 2004 [3]



# Tunneling IP Datagrams

Both home agents and foreign agents (v4) must support tunneling datagrams using IP-in-IP encapsulation and decapsulation.

MNs that use a co-located COA must also support decapsulation (v6).

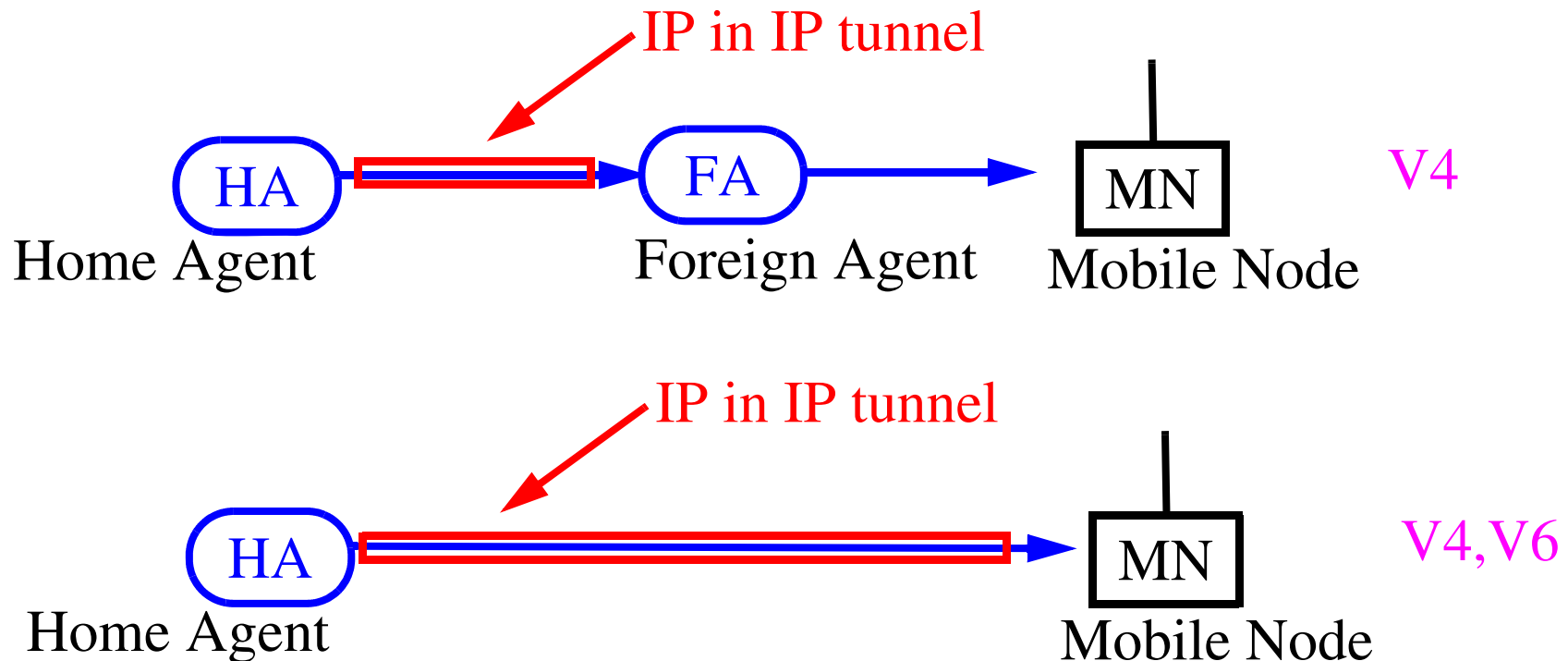

# Temporary Address Assignment

Two types of temporary Care-Of-Address:

- **Foreign agent care-of address (V4)**
  - a care-of address provided by a foreign agent through its Agent Advertisement messages.
- **Co-located care-of address (V4, V6)**
  - a care-of address acquired by the mobile node as a local IP address through some external means, eg. dynamically acquired as a temporary address through dynamic host configuration protocol (DHCP) RFC 1541, or the address may be owned by the MN as a long-term address for its use while visiting this foreign network.

# Agent Discovery

Why Agent Discovery?

Methods an MN can use to determine whether it is currently at its home network or a foreign network. By:

- **Agent Advertisement**
  - periodic transmissions (beacons) sent by a mobility agent (rate limited to max. 1/s).
- **Agent Solicitation**
  - Send by an MN to discover agents.

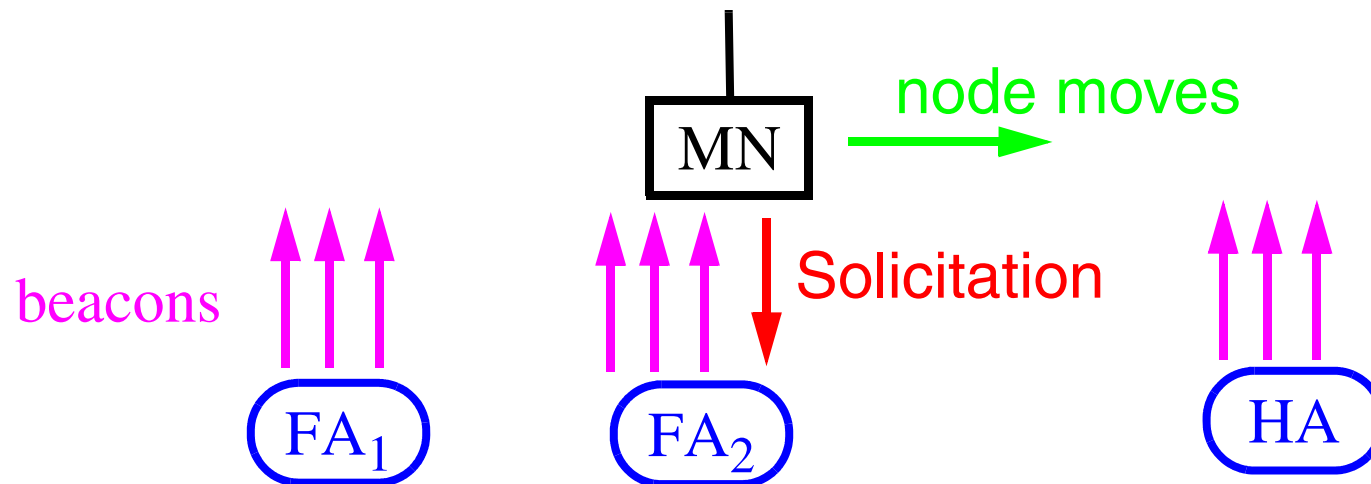

# Agent Advertisement Message Format

Extension of an ICMP router advertisement

|  |   |        |                 |    |
|--|---|--------|-----------------|----|
| 0  | 8 | 16     | 24              | 31 |
| TYPE (16)  |   | Length | Sequence Number |    |
| Lifetime   |   | CODE   | Reserved        |    |
| Care of Address* {the number is determined by the length field; must be at least 1 of F bit set} |   |        |                 |    |

| Bit | Name | Meaning  |
|-----|------|--|
| 0   | R    | Registration with this foreign agent (or another foreign agent on this link) is required; using a co-located care-of address is not permitted. |
| 1   | B    | Busy. Foreign agent not accepting registrations from additional mobile nodes.  |
| 2   | H    | Agent offers service as a home agent.  |
| 3   | F    | Agent offers service as a foreign agent.   |
| 4   | M    | Agent implements receiving tunneled datagrams that use minimal encapsulation   |
| 5   | G    | Agent implements receiving tunneled datagrams that use GRE encapsulation   |
| 6   | V    | Agent supports Van Jacobson header compression over the link with any registered mobile node.  |
| 7   |      | reserved (must be zero)  |

# Registration Message Format

|  |       |          |    |    |
|--|-------|----------|----|----|
| 0  | 8     | 16       | 24 | 31 |
| TYPE (1 or 3)  | FLAGS | Lifetime |    |    |
| Home Address   |       |          |    |    |
| Home Agent   |       |          |    |    |
| Care of Address* {the number is determined by the length field; must be at least 1 of F bit set} |       |          |    |    |
| Identification   |       |          |    |    |
| Extensions   |       |          |    |    |

| Bit | Name | Meaning  |
|-----|------|--|
| 0   | S    | Simultaneous bindings, this is an additional address for the mobile                        |
| 1   | B    | Broadcast datagrams. Home agent to tunnel any broadcast packets it receives to the mobile. |
| 2   | D    | Mobile using co-located care-of address and will decapsulation itself                      |
| 3   | M    | Mobile requests home agent to use Minimal encapsulation.                                   |
| 4   | G    | Mobile requests home agent to use GRE encapsulation.                                       |
| 5   | V    | Mobile node requests that agent use Van Jacobson header compression.                       |
| 6-7 |      | reserved (must be zero)  |

# MN Requirements

An MN must have:

- home address, netmask,
- mobility security association for each HA.

For each pending registration, MN maintains the following information:

- link-layer address of the FA to which the Registration Request was sent
- IP destination address of the Registration Request
- Care-of address used in the registration
- remaining lifetime of the registration

# FA Requirements (v4)

- Each FA must be configured with a **care-of-address**.
- Must maintain a **visitor list** with following information:
  - Link-layer source address of the mobile node
  - IP Source Address (the MN's Home Address)
  - UDP Source Port
  - Home Agent address
  - Requested registration Lifetime
  - Identification field

This visitor list acts much like a [Visitor Location Register \(VLR\)](#) in a cellular system.

# HA Requirements

Each HA must have:

- the home address and mobility security association of each authorized MN that it is serving as a home agent.

Must create or modify its **mobility binding list** entry containing:

- Mobile node's CoA (or CoAs in the case of simultaneous bindings)
- Identification field from the Registration Request
- Remaining Lifetime of the registration

The mobility binding list acts much like a [Home Location Register](#) (HLR) in a cellular system.



# Optimization Problem

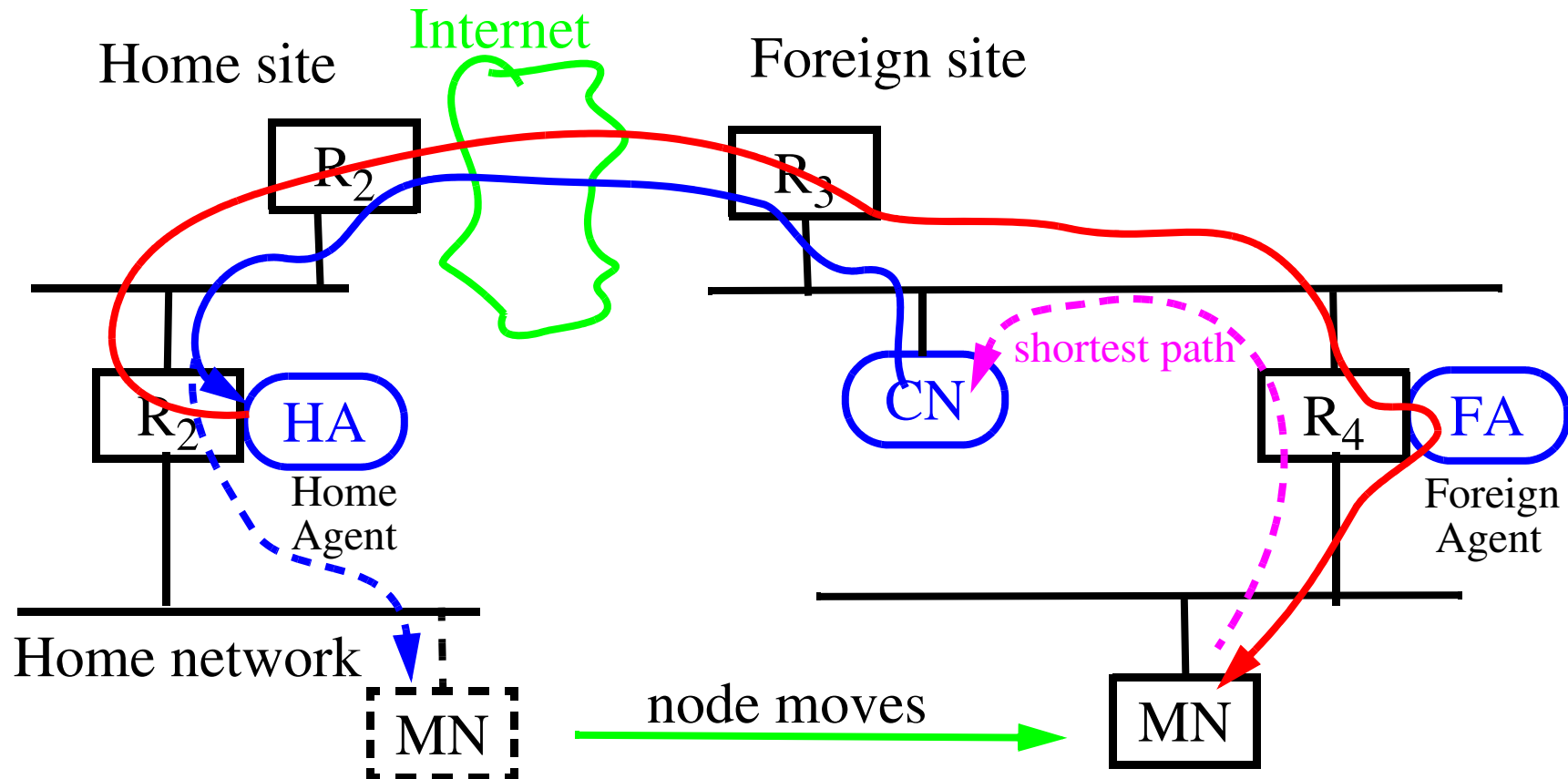

We can **not** follow the shortest path in Mobile IPv4 because the CN will always send it via our home network. However, we may be able to use the shortest path from the MN to the CN.

# Problems of Mobile IP (RFC2002)

- |  |                     |
|--|---------------------|
| <ul style="list-style-type: none"><li>• Only provides basic “macro mobility” support</li><li>• Not developed for cellular systems</li><li>• No interface defined between cellular systems (e.g. between Mobile-IP/HLR/VLR)</li><li>• No handover support</li></ul> | } ⇒ Cellular        |
| <ul style="list-style-type: none"><li>• Weak in security</li><li>• No key distribution mechanism</li></ul>   | } Security          |
| <ul style="list-style-type: none"><li>• Route optimization problems</li></ul>  | ⇒ Optimization      |
| <ul style="list-style-type: none"><li>• No QoS, real-time support, (DiffServ, RSVP)</li></ul>  | ⇒ QoS and Real-time |
| <ul style="list-style-type: none"><li>• ...</li></ul>  |                     |

# Mobile IP Problems and Development

- Cellular Micro Mobility:
  - CDMA2000 Extension to MIP
  - Cellular IP
  - Regional Tunnel Management
  - Hierarchical MIPv6 Handoffs
  - MIP based Micro Mobility Mgt
- Security:
  - Mobile IP NAI Extension
  - AAA Registration Keys for MIP
  - Registration Keys for Route Optimization
  - Mobile IP Challenge/Response Extensions
- Route Optimization:
  - Route optimization for MIPv4, v6
- Real-time QoS:
  - No solution yet

# CDMA2000 Extension to Mobile IP

A draft entitled: Mobile IP Based Micro Mobility Management Protocol in the Third Generation Wireless Network, by 3Com, Alcatel, Cisco, Ericsson, Lucent, Nortel, Motorola, Samsung, etc.

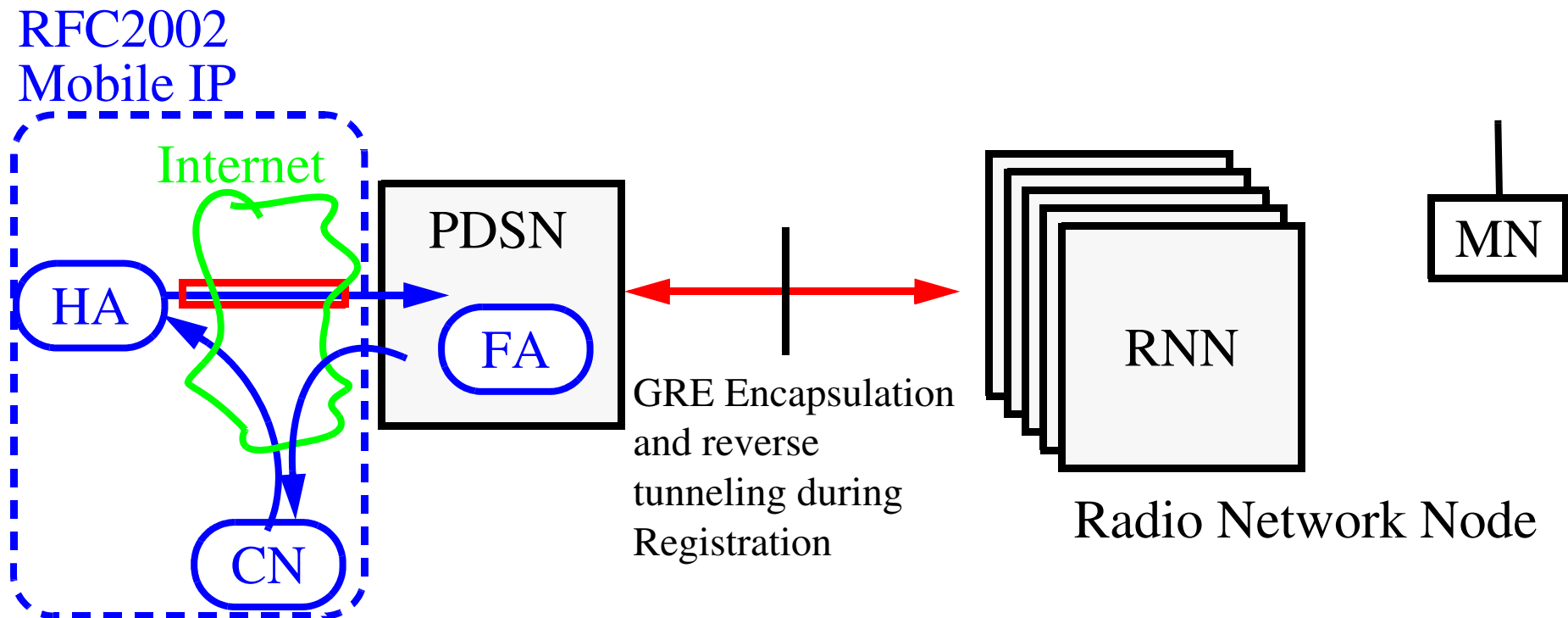

# Wireless IP Network Architecture

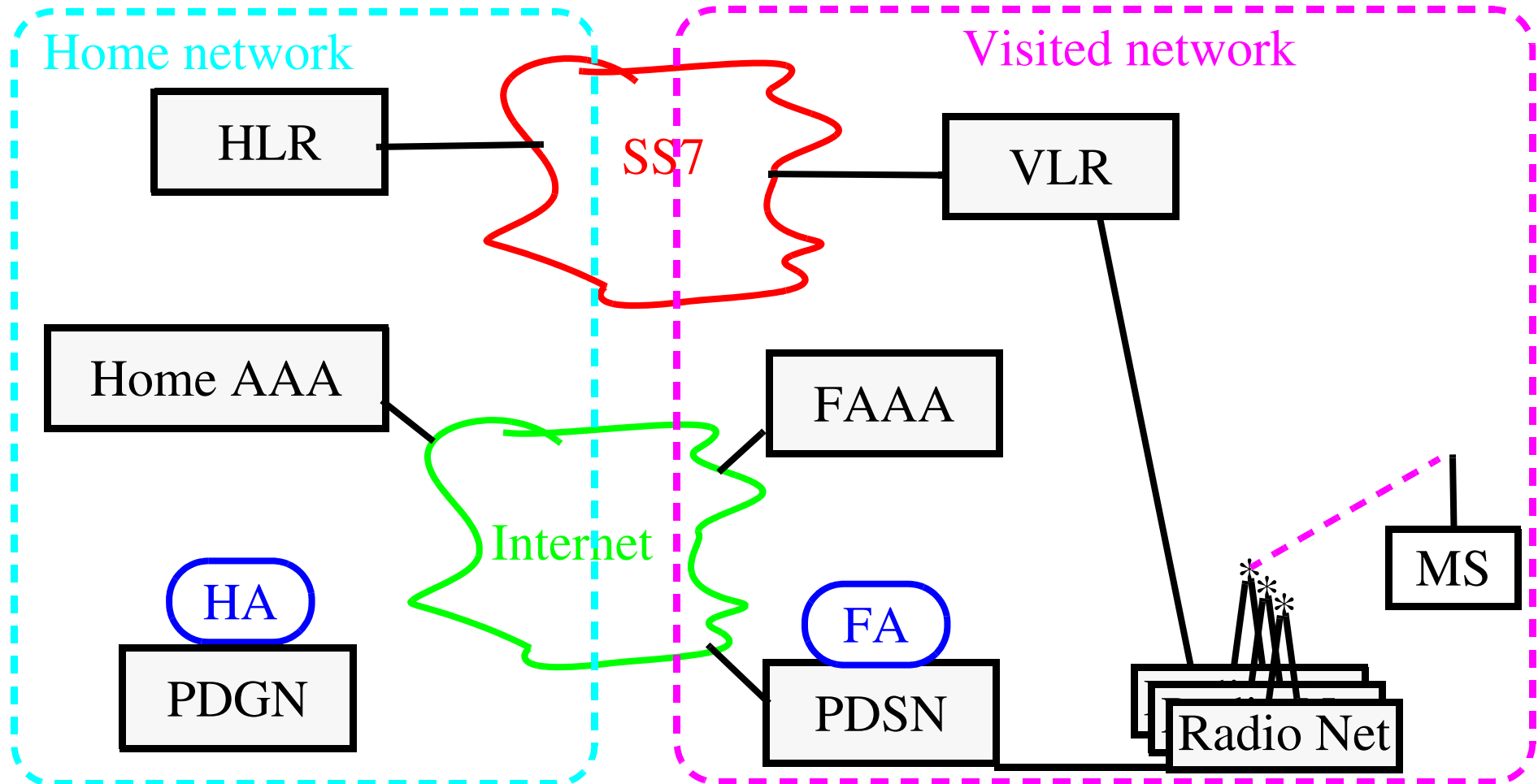

# Cellular IP (CIP)

HAWAII extension is similar to Cellular IP.

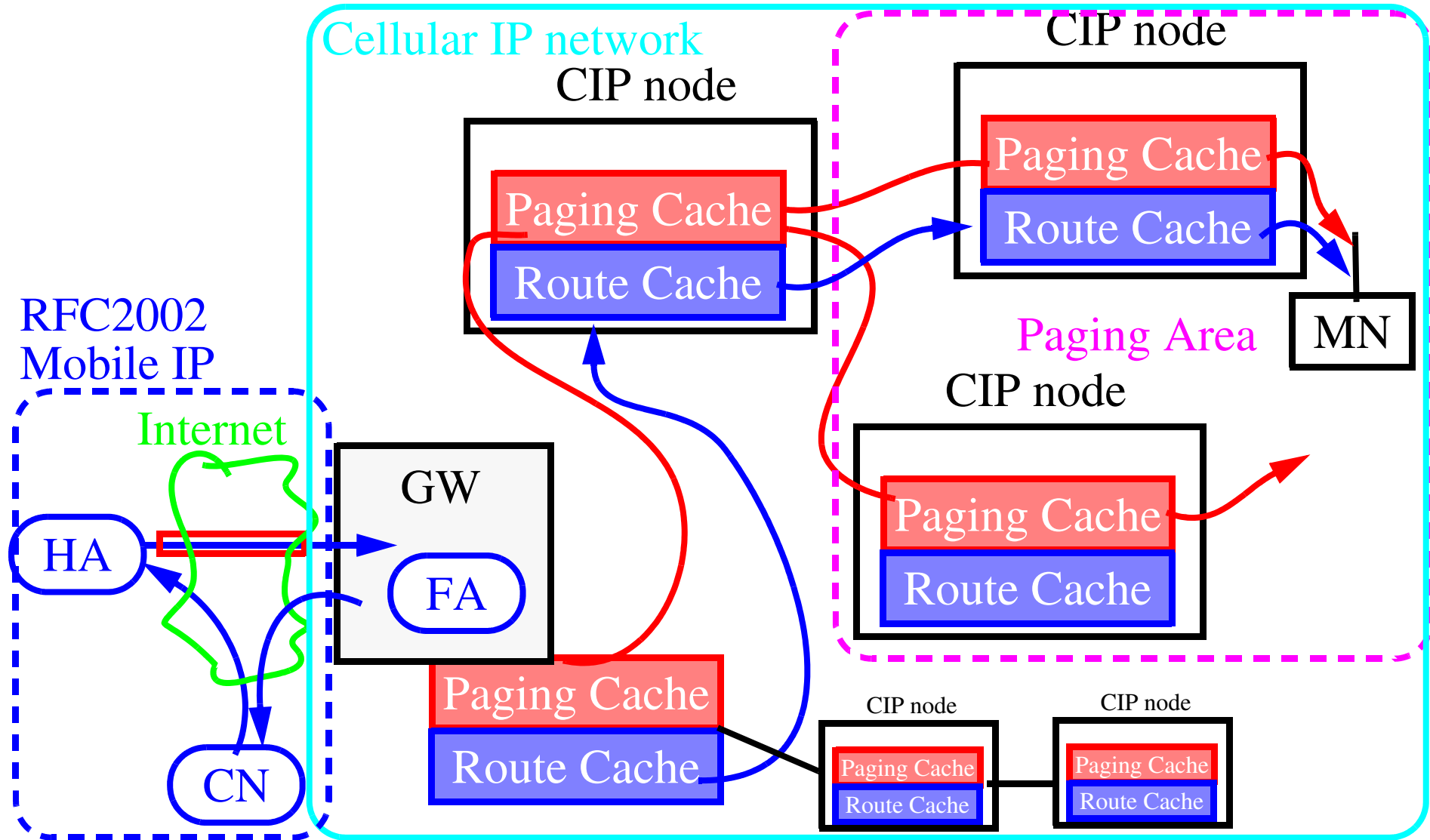

# Cellular IP (CIP): Handover

HAWAII extension is similar to Cellular IP.

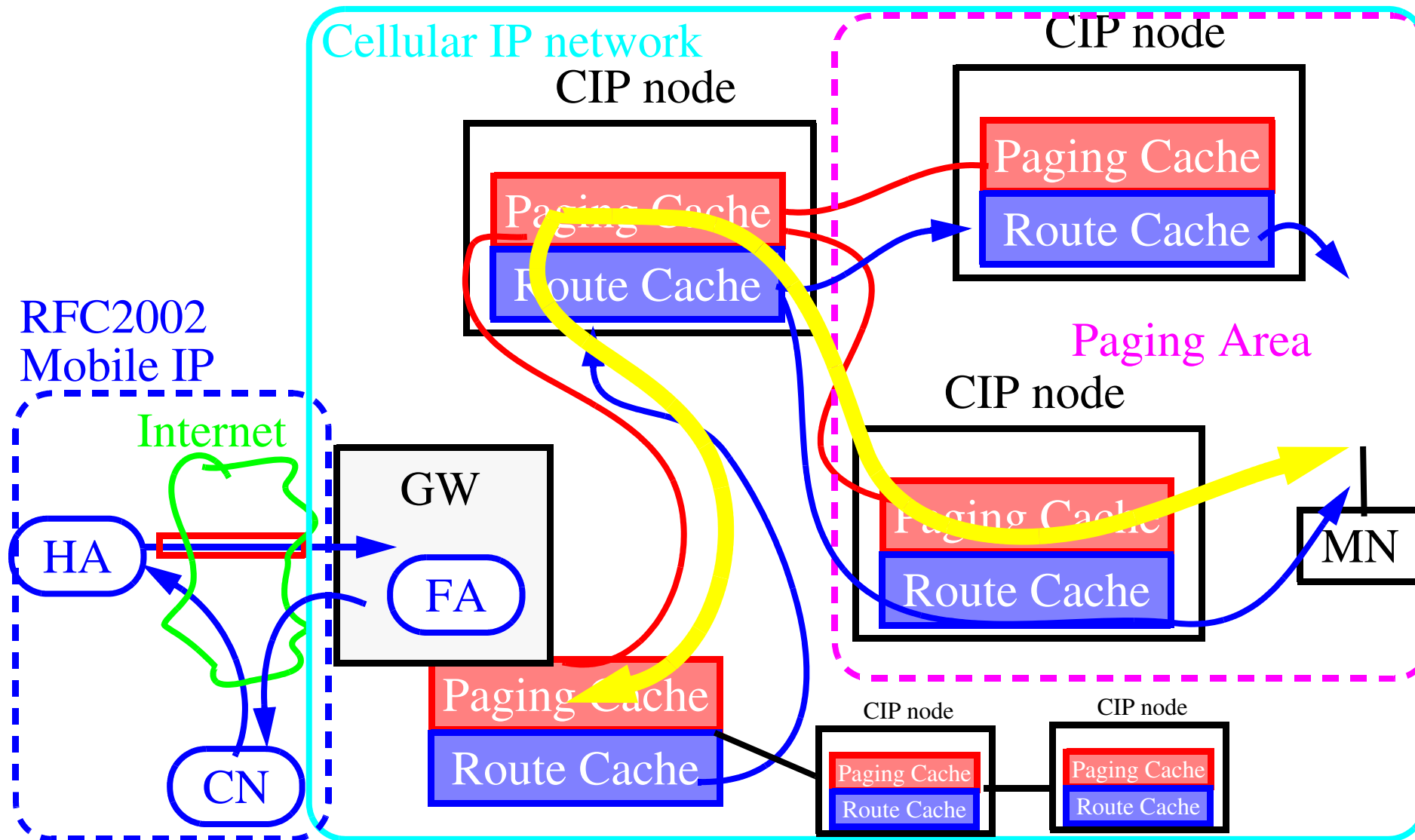

# Cellular IP (CIP): Location Update

HAWAII extension is similar to Cellular IP.

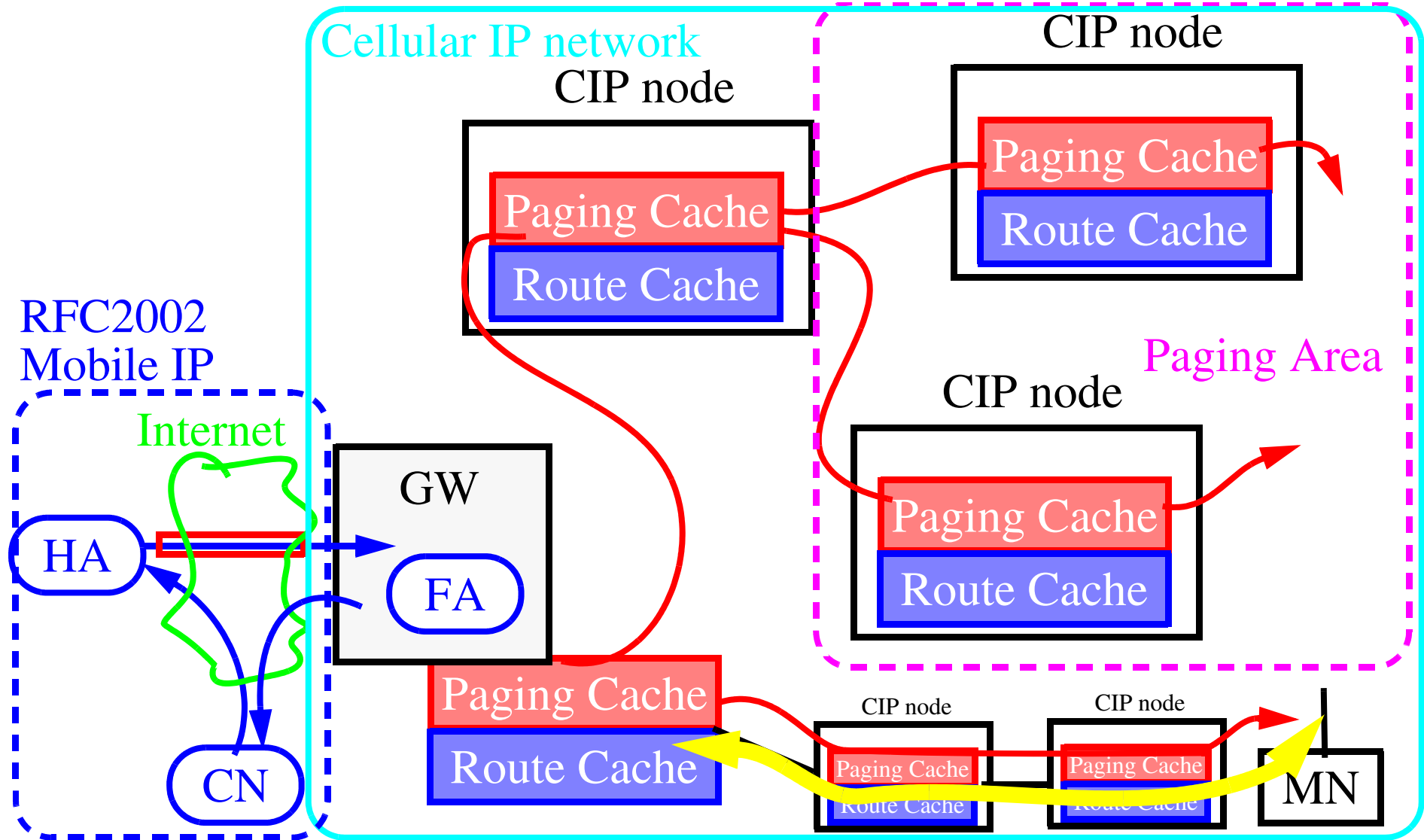



# Hierarchical FA and Regional Tunneling

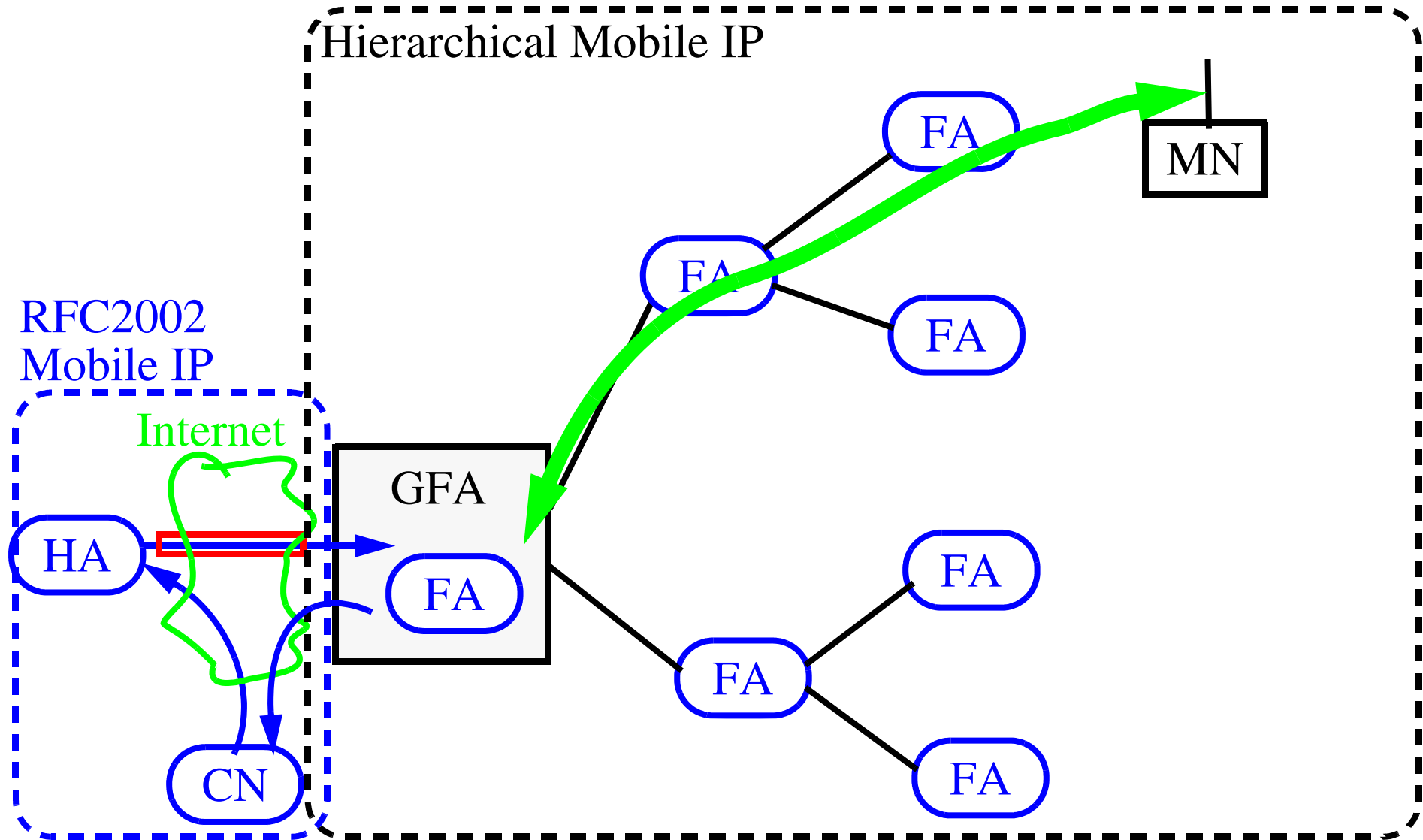

# Hierarchical FA and Regional Tunneling

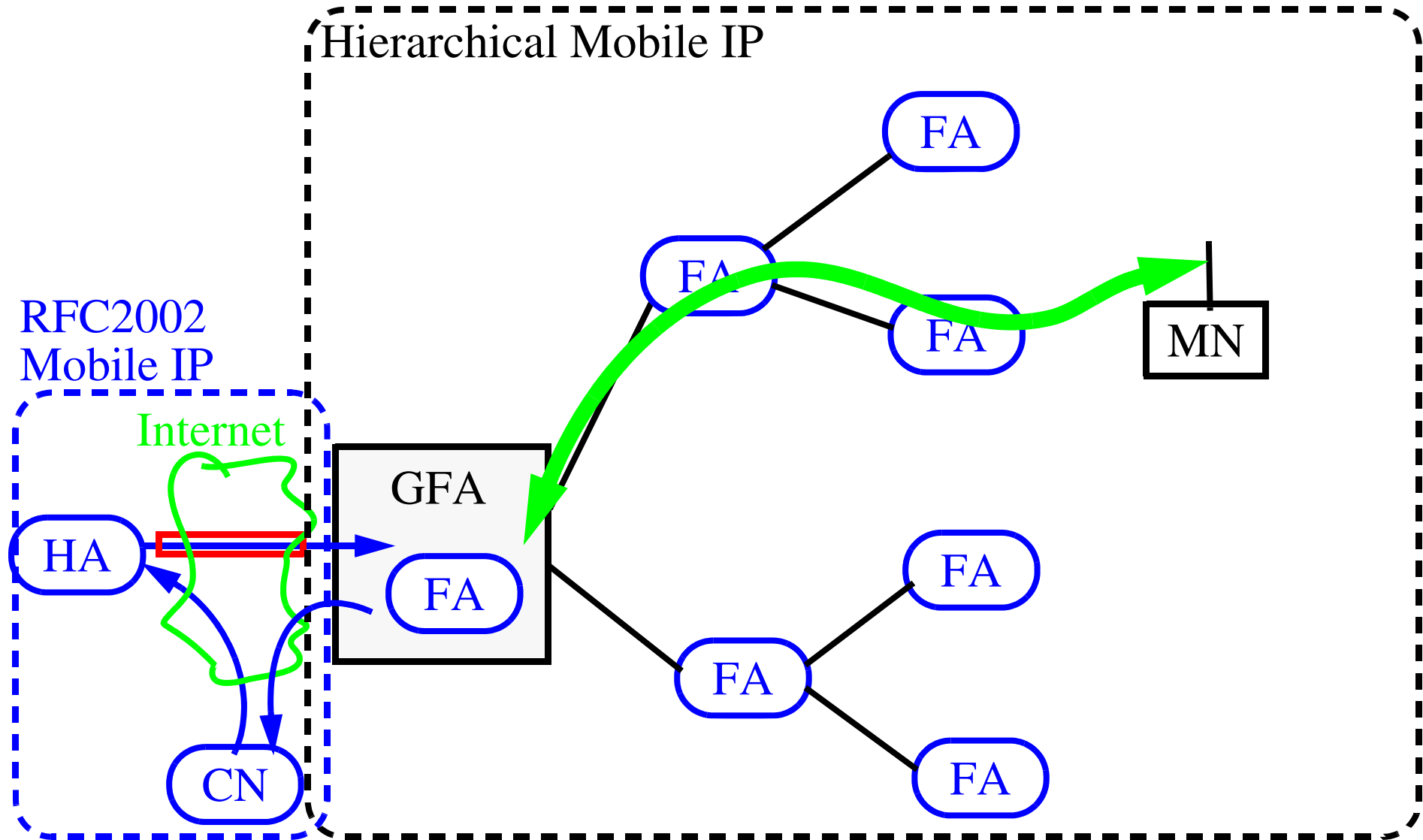

# Hierarchical FA and Regional Tunneling

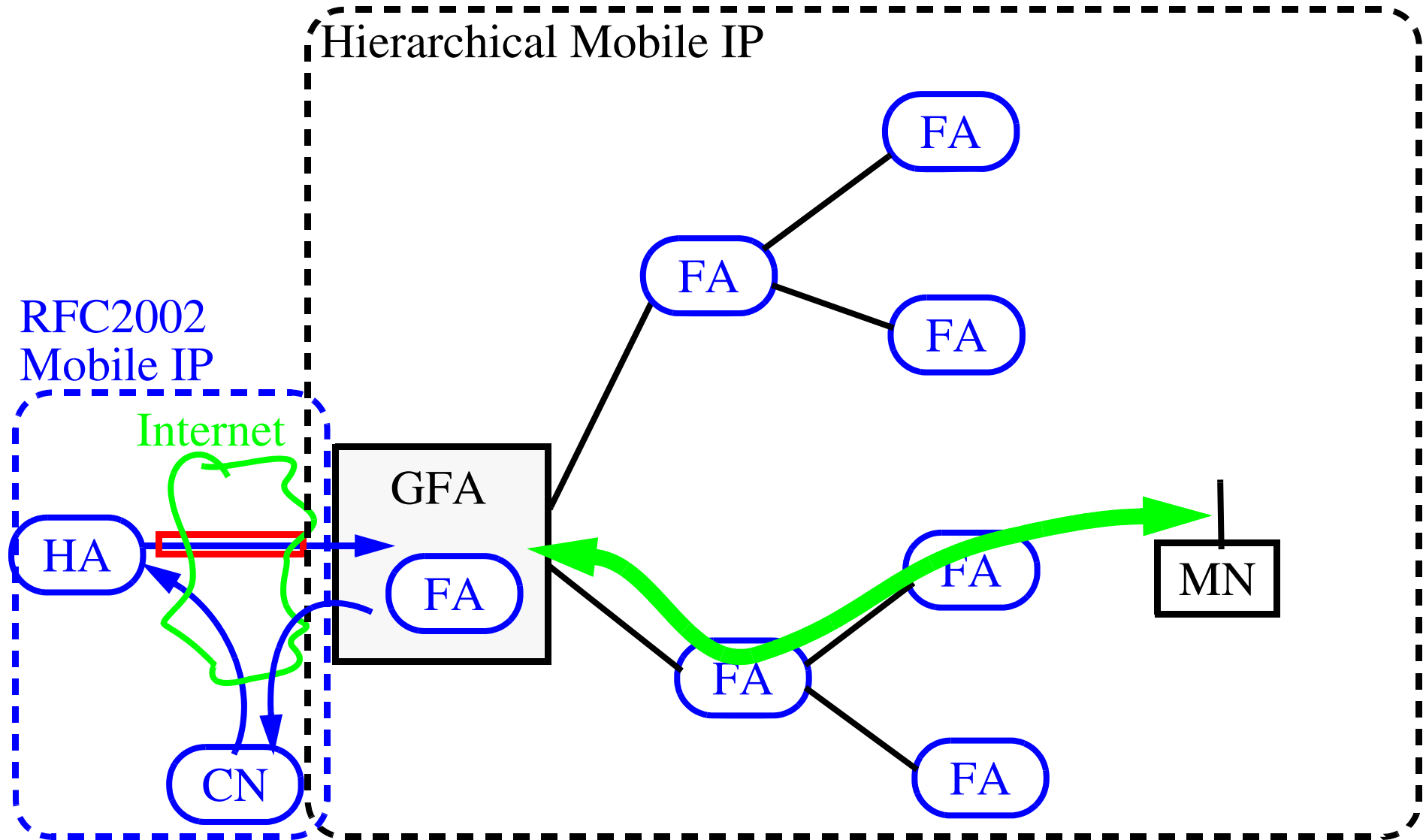

# Why not simply use Dynamic DNS (DDNS)?

## Problems of Dynamic DNS Mobility

- Only support inter-session mobility.
- TCP has to be disconnected when changing net.
- No inter-networking handover.
- Performance limitation problems.
- Security, Intranet firewall, etc.

|                          | Mobile IP    | Dynamic DNS |
|--------------------------|--------------|-------------|
| TCP survive the movement | Yes          | No          |
| Intra-session mobility   | Yes          | No          |
| Handover Support         | (Working on) | No          |
| Performance Limitation   | No           | Yes         |

Thus DDNS does not really provide mobility, just connecting at different places.

# Summary

This lecture we have discussed:

- Mobile IP

# References

- [1] . B. Aboba and M. Beadles, “The Network Access Identifier”, IETF RFC 2486, January 1999  
<http://www.ietf.org/rfc/rfc2486.txt>
- [2] C. Perkins, “IP Encapsulation within IP”, IETF RFC 2003, October 1996 <http://www.ietf.org/rfc/rfc2003.txt>
- [3] C. Perkins, “Minimal Encapsulation within IP”, IETF RFC 2004, October 1996 <http://www.ietf.org/rfc/rfc2004.txt>
- [4] Juan Caballero Bayerri and Daniel Malmkvist, Experimental Study of a Network Access Server for a public WLAN access network, M.S. Thesis, KTH/IMIT, Jan. 2002

# IK1550 Internetworking/Internetteknik

## Spring 2010, Period 4

### Module 12: IPSec, VPNs, Firewalls, and NAT

Lecture notes of G. Q. Maguire Jr.



KTH Information and  
Communication Technology

© 2010 G.Q.Maguire Jr. .

All rights reserved. No part of this course may be reproduced, stored in a retrieval system, or transmitted, in any form or by any means, electronic, mechanical, photocopying, recording, or otherwise, without written permission of the author.

Last modified: 2010.03.21:17:36

# Outline

- IPSec, VPN, ...
- Firewalls & NAT
- Private networks



# Private networks

Private Networks are designed to be used by a limited set of users (generally those inside an organization)

|          |  |
|----------|--|
| Intranet | a private network - access limited to those in an organization                               |
| Extranet | intranet + limited access to some resource by additional users from outside the organization |

## Addresses for Private IP networks

- these should never be routed to outside the private network
- they should never be advertised (outside the private network)
- allocated (**reserved**) addresses:

| Range                          | Total addresses |
|--------------------------------|-----------------|
| 10.0.0.0 to 10.255.255.255     | $2^{24}$        |
| 172.16.0.0 to 172.31.255.255   | $2^{20}$        |
| 192.168.0.0 to 192.168.255.255 | $2^{16}$        |

# Virtual Private networks (VPNs)

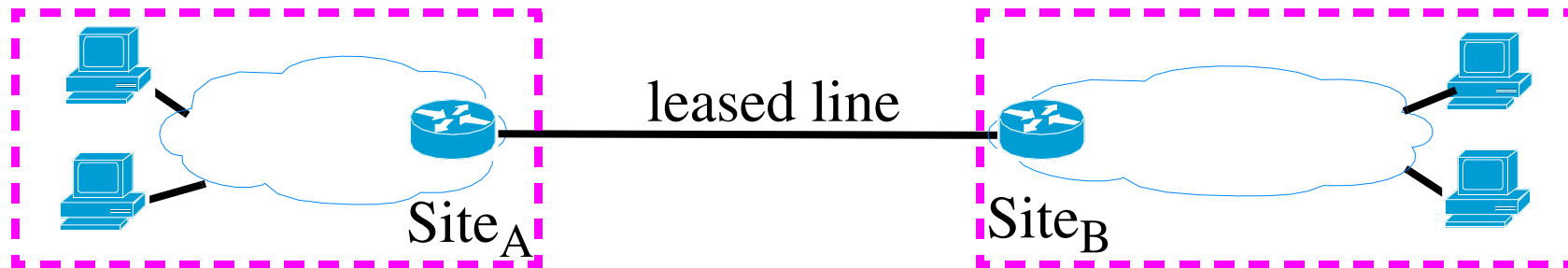

Figure 1: Private network

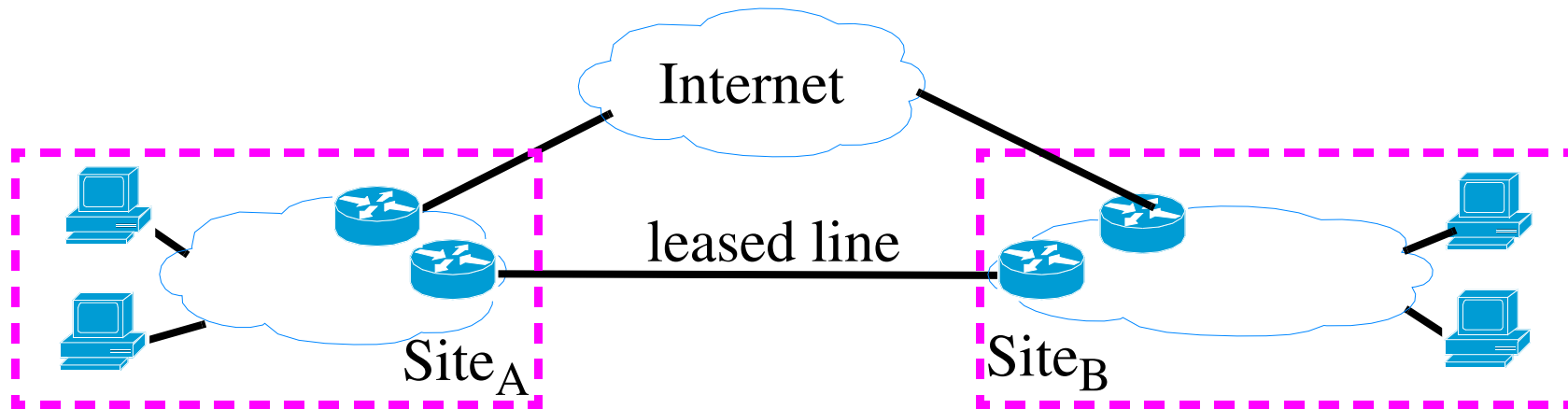

Figure 2: Hybrid network

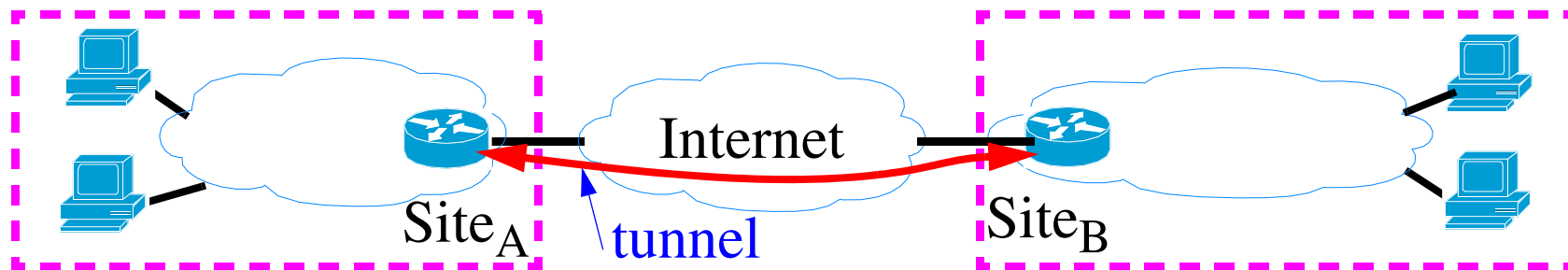

Figure 3: Virtual Private network

# Security Protocols, APIs, etc.

- Generic Security Services App. Programming Interface (GSS-API)
- Network layer security
  - Internet Protocol Security Protocol (IPSEC)
- Secured Socket Layer (SSL)/Transport Layer Security
  - transport layer security
  - Secured HyperText Transport Protocol (S-HTTP)
- Application layer security
  - Pretty Good Privacy (PGP) [22]
  - Privacy-Enhanced Electronic Mail (PEM), S/MIME (signed MIME), PGP/MIME, and OpenPGP, ... [23]
  - MasterCard and Visa's Secured Electronic Transaction (SET)
- Authentication
  - Remote Authentication Dial-In User Services (RADIUS)  
<http://www.gnu.org/software/radius/radius.html>, FreeRADIUS <http://www.freeradius.org/>
  - DIAMETER <http://www.diameter.org/>
  - ...

# GSS-API

Generic Security Services Application Programming Interface (GSS-API)

- provides an abstract interface which provides security services for use in distributed applications
- but isolates callers from specific security mechanisms and implementations.

GSS-API peers establish a common security mechanism for security context establishment either through administrative action, or through negotiation.

GSS-API is specified in:

- J. Linn, "Generic Security Service API v2", RFC 2078 [8]
- J. Wray, "Generic Security Service API v2: C-bindings", RFC 2744 [9].

# IPSec

IPSec in three parts:

- encapsulating security payload (ESP) defines encryption or IP payloads,
- authentication header (AH) defines authentication method, and
- the IP security association key management protocol (ISAKMP) manages the exchange of secret keys between senders and recipients of ESP or AH packets.

# ESP packet

Consists of:

- a control header - contains a Security Parameters Index (SPI) and a sequence number field (the SPI + destination IP address uniquely identifies the Security Association (SA)).
- a data payload - encrypted version of the user's original packet. It may also contain control information needed by the cryptographic algorithms (for example DES needs an initialization vector (IV)).
- an optional authentication trailer - contains an Integrity Check Value (ICV) - which is used to validate the authenticity of the packet.

ESP could use any one of several algorithms: DES, Triple DES, ...

See: RFC 2406: IP Encapsulating Security Payload (ESP)[2]

# AH header

For authentication purposes only contains:

- an SPI,
- a sequence number, and
- an authentication value.

AH uses either:

- Message Digest 5 (MD5) algorithm,
- Secure Hash Algorithm 1 (SHA-1),
- truncated HMAC (hashed message authentication code), or
- ...

For further information see:

- IP Authentication Header - RFC 2402 [3]

# ISAKMP

ISAKMP is based on the Diffie-Hellman key exchange protocol; it assumes the identities of the two parties are known.

Using ISAKMP you can:

- control the level of trust in the keys,
- force SPIs to be changed at an appropriate frequency,
- identify keyholders via digital certificates  
[requires using a certificate authority (CA)]

For further information see:

- Internet Security Association and Key Management Protocol (ISAKMP) - RFC 2408 [4]
- The Internet IP Security Domain of Interpretation for ISAKMP - RFC 2407 [5]
- The OAKLEY Key Determination Protocol - RFC 2412 [6]
- The Internet Key Exchange (IKE) - RFC 2409 [7]



# Where can you run IPsec?

| Mode       | Where it runs  | Payload   |
|------------|--|---|
| Transport  | end-systems  | payload data follows the normal IP header   |
| Tunnelling | internetworking device: e.g., router, firewall, or VPN gateway | <ul style="list-style-type: none"><li>• end-user's entire packet-IP headers and all-placed within another packet with ESP or AH fields [thus it is encapsulated in another packet]</li><li>• can hide the original source and destination address information</li></ul> |

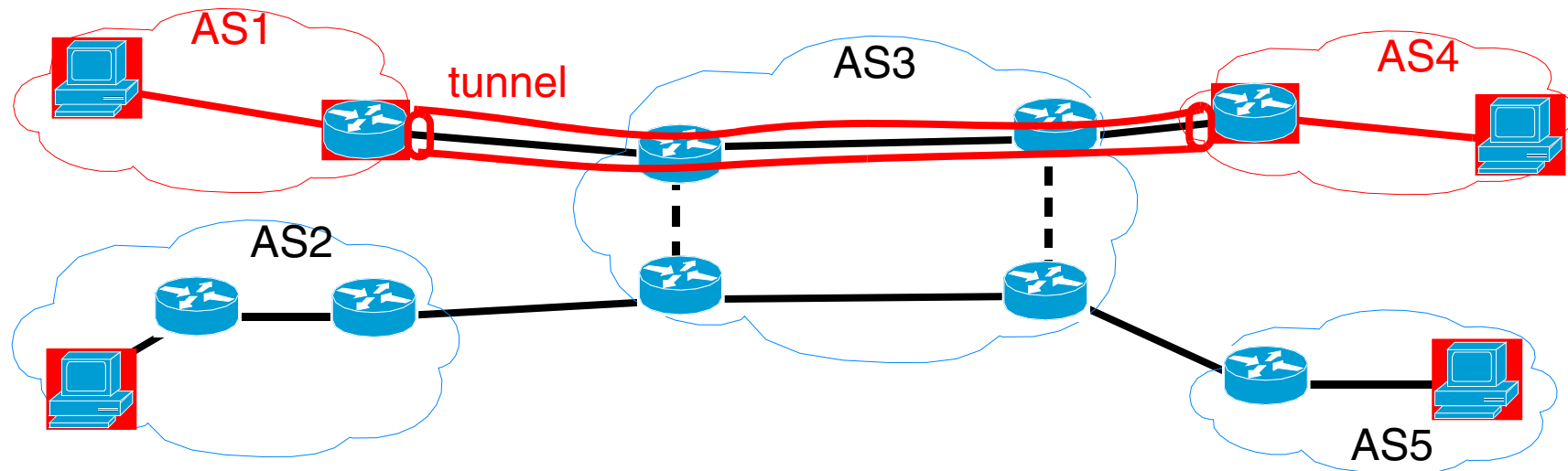

Figure 4: IPsec usage  
red = secure, black = unsecure

# Firewalls

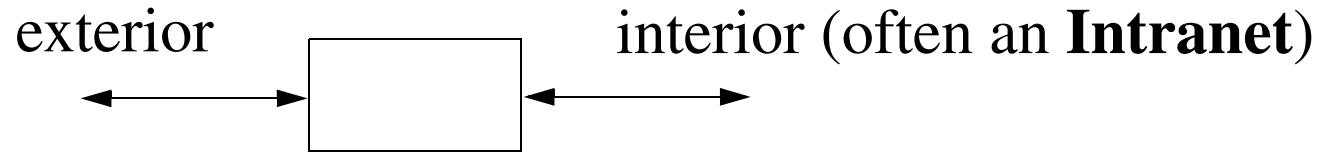

Figure 5: Firewall an internet gateway

The firewall can provide packet by packet filtering of packets coming into the **intranet** or leaving the intranet. The firewall can decide which packets should be forwarded based on [source](#), [destination addresses](#), and [port](#) (or even deeper examination) using an explicitly defined **policy**.

# Linux firewall

For example, for the software firewall used in Linux systems called “ipfwadm”:

- all ports are typically closed for inbound traffic,
- all outbound traffic is “IP masqueraded”, i.e., appears to come from the gateway machine; and
- For bi-directional services required by the users, “holes” may be punched through the firewall - these holes can reroute traffic to/from particular ports:
  - to specific users or
  - the most recent workstation to request a service.

# Firewall Design

apply basics of security:

- **least privilege:**
  - don't make hosts do more than they have to (implies: specialize servers)
  - use minimum privileges for the task in hand
- **fail safe**
  - even if things break it should not leave anything open
- **defence in depth**
  - use several discrete barriers - don't depend on a single firewall for all security
- **weakest links**
  - know the limitations of your defences - understand your weakest link

Firewalls should have sufficient performance to keep the pipes full - i.e., a firewall should not limit the amount of traffic flowing across the connection to the external network, only **what** flows across it!

# Proxy Access Through A Firewall

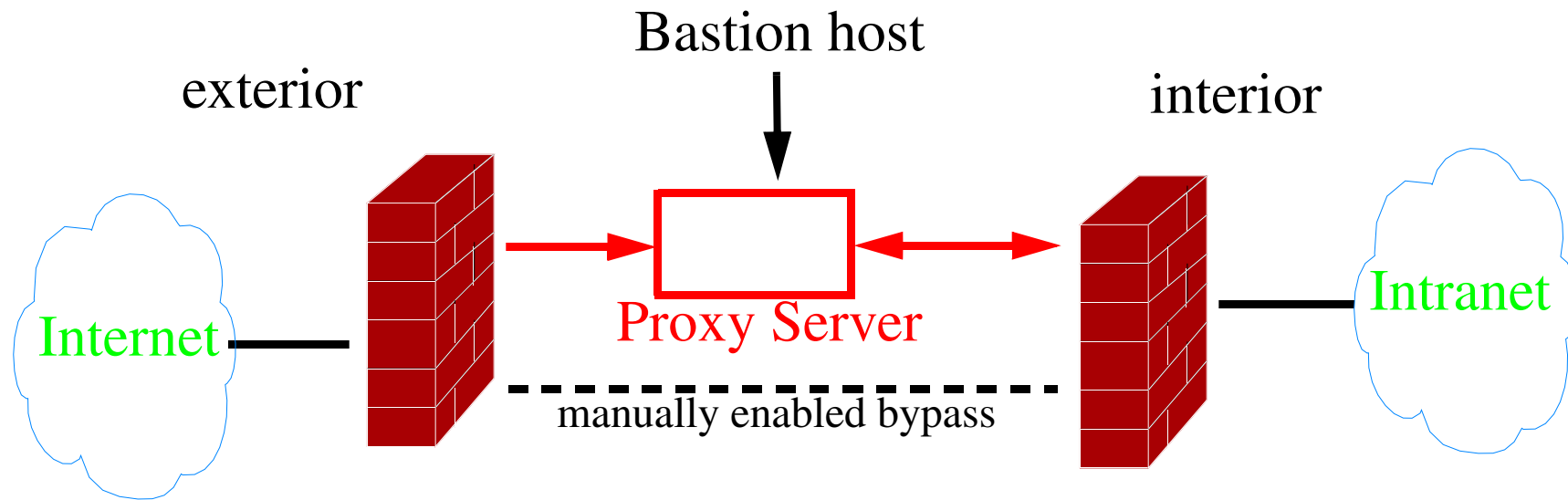

Figure 6: Firewall and internet gateway

Often you need application level proxies (i.e., they understand details of the application protocol) -- an example is to proxy RealAudio's streaming audio.

# SOCKs

Permeo Technologies, Inc.'s SOCKS <http://www.socks.nec.com/>

In order to bridge a firewall we can use a proxy:

- the proxy will appear to be **all external hosts** to those within the firewall
  - for example, If a user attached to the intranet requests a webpage, the request is sent to the proxy host where the same request is duplicated and sent to the real destination. When data is returned the proxy readdresses (with the user's intranet address) the returned data and sends it to the user.
- widely used to provide proxies for commonly used external services (such as Telnet, FTP, and HTTP).

See: [16] and [17]

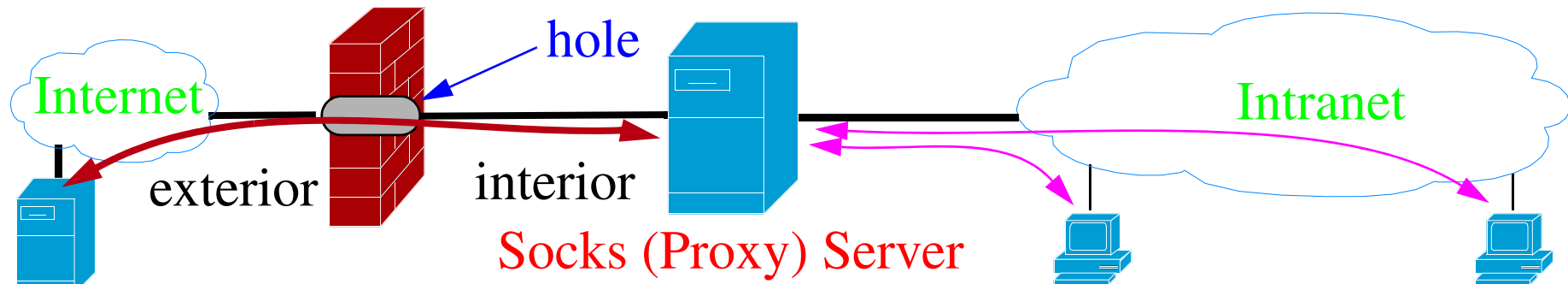

Figure 7: Firewall and internet gateway

# Newping

<http://ftp.cerias.purdue.edu/pub/tools/dos/socks.cstc/util/newping.c>

- a “ping” for SOCKS
- it depends on the target host **not** blocking the service on the appropriate port (in this case “**time**”). This version is primarily for checking “Is it alive?” rather than gathering statistics on the average response time of several echo requests.
- Uses the “**time**” TCP port to verify that a host is up, rather than using ICMP ⇒ usable through a firewall that blocks ICMP.

# MBONE through firewalls

<http://www.cs.virginia.edu/~mngroup/projects/firewalls/>

Their firewall features:

- Source host checking (allowing only certain hosts to transmit through the firewall, or denying specific hosts)
- Destination port checking
- Packet contents (unwrapping encapsulated IP)
- Regulating bandwidth allocated to a specific multicast group's traffic

Their Mbone gateway is based on a modified multicast routing daemon.

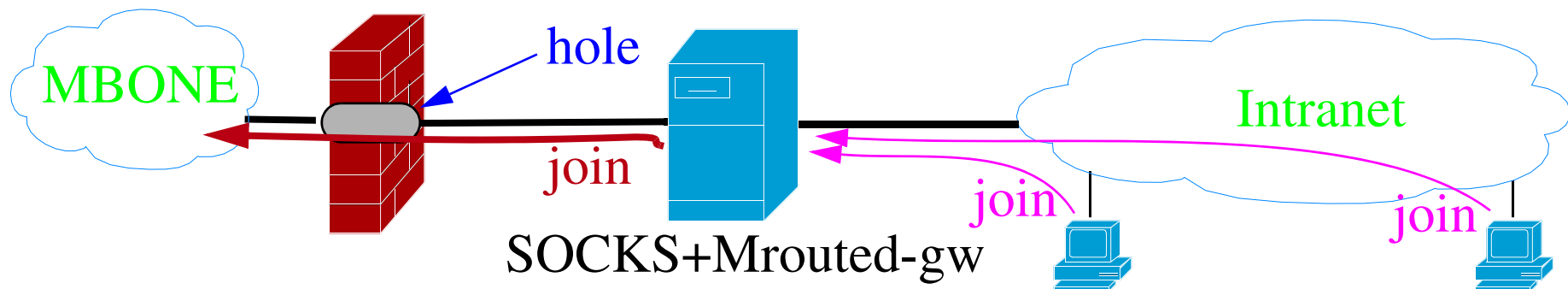

Figure 8: Firewall and internet gateway



# Secure Mailer (aka Postfix)

Wietse Venema's attempt to provide an alternative to the widely-used Sendmail program

70% of all mail sent via the Internet is sent via Sendmail

“Security. Postfix uses multiple layers of defense to protect the local system against intruders. Almost every Postfix daemon can run in a chroot jail with fixed low privileges. There is no direct path from the network to the security-sensitive local delivery programs - an intruder has to break through several other programs first. Postfix does not even trust the contents of its own queue files, or the contents of its own IPC messages. Postfix avoids placing sender-provided information into shell environment variables. Last but not least, no Postfix program is set-uid.” [18]

# U.S. DOE CIAC's Network Security Tools [19]

- System Administrator Tool for Analyzing Networks (**SATAN**), network security analyzer designed by Dan Farmer and Wietse Venema; scans systems connected to the network noting the existence of well known, often exploited vulnerabilities. (see also Security Auditor's Research Assistant (SARA))
- **ipacl** - forces all TCP and UDP packets to pass through an access control list facility
- **logdaemon** - modified versions of rshd, rlogind, ftpd, rexecd, login, and telnetd that log significantly more information -- enabling better auditing of problems via the logfiles
- improved versions of: portmap, rpcbind,
- **screend** - a daemon and kernel modifications to allow all packets to be filtered based on source address, destination address, or any other byte or set of bytes in the packet
- **securelib** - new versions of the accept, recvfrom, and recvmsg networking system calls

- **TCP Wrappers** - allows monitoring and control over who connects to a host's TFTP, EXEC, FTP, RSH, TELNET, RLOGIN, FINGER, and SYSTAT ports + a library so that other programs can be controlled and monitored in the same fashion
- **xinetd** - a replacement for inetd which supports access control based on the address of the remote host and the time of access + provides extensive logging capabilities

# The Network Mapper (NMAP)

## Network Mapper (NMAP) <http://www.insecure.org/nmap/>

- (cleverly) uses raw IP packets
- determine what hosts are available on the network,
- what services (application name and version) are offered,
- what operating systems (and OS versions) they are running,
- what type of packet filters/firewalls are in use,
- ...

[http://www.insecure.org/nmap/nmap\\_documentation.html](http://www.insecure.org/nmap/nmap_documentation.html) also has a link to “[Remote OS detection via TCP/IP Stack FingerPrinting](#)” by Fyodor <fyodor@dhp.com> (www.insecure.org), October 18, 1998 - a means of identifying which OS the host is running by noting its TCP/IP behavior.

# Network Address Translation

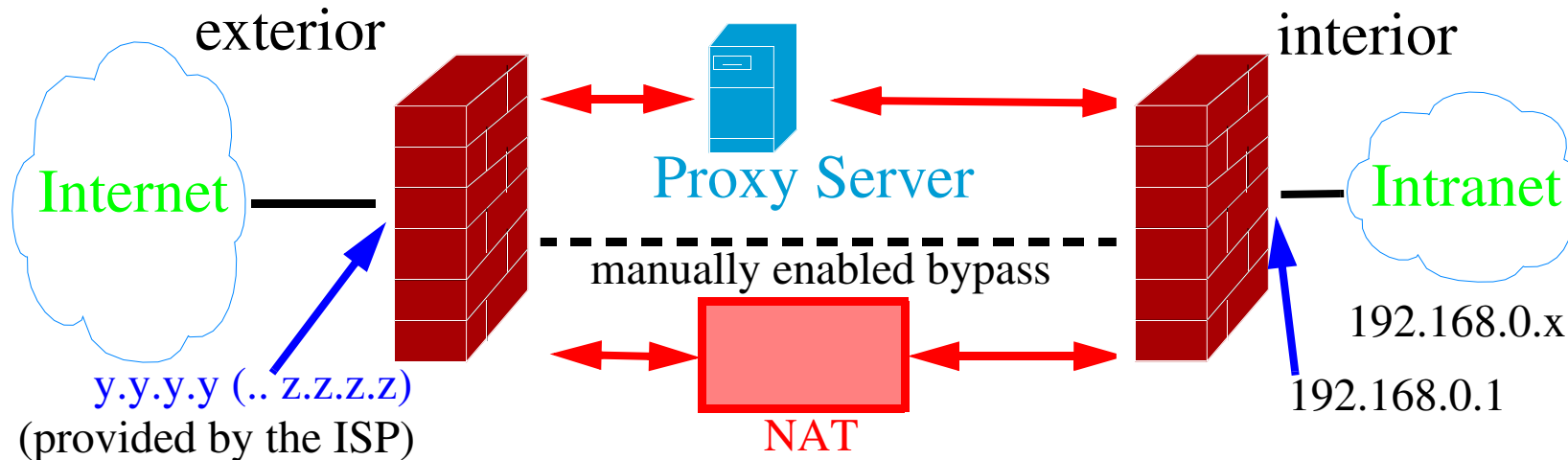

Figure 9: Example of a Firewall with NAT

NAT maps IP addresses on the inside to one or more addresses on the outside and vice versa. See RFC 3022 [29] and RFC2766 [30]

## Advantages:

- ✓ save IPv4 addresses
- ✓ hides internal node structure from outside nodes
- ✓ the intranet does not have to be renumbered when you connect to another ISP

## Disadvantage

- ✗ Unfortunately this breaks many services because they use an IP address inside the their data.

# Demilitarized zone (DMZ)

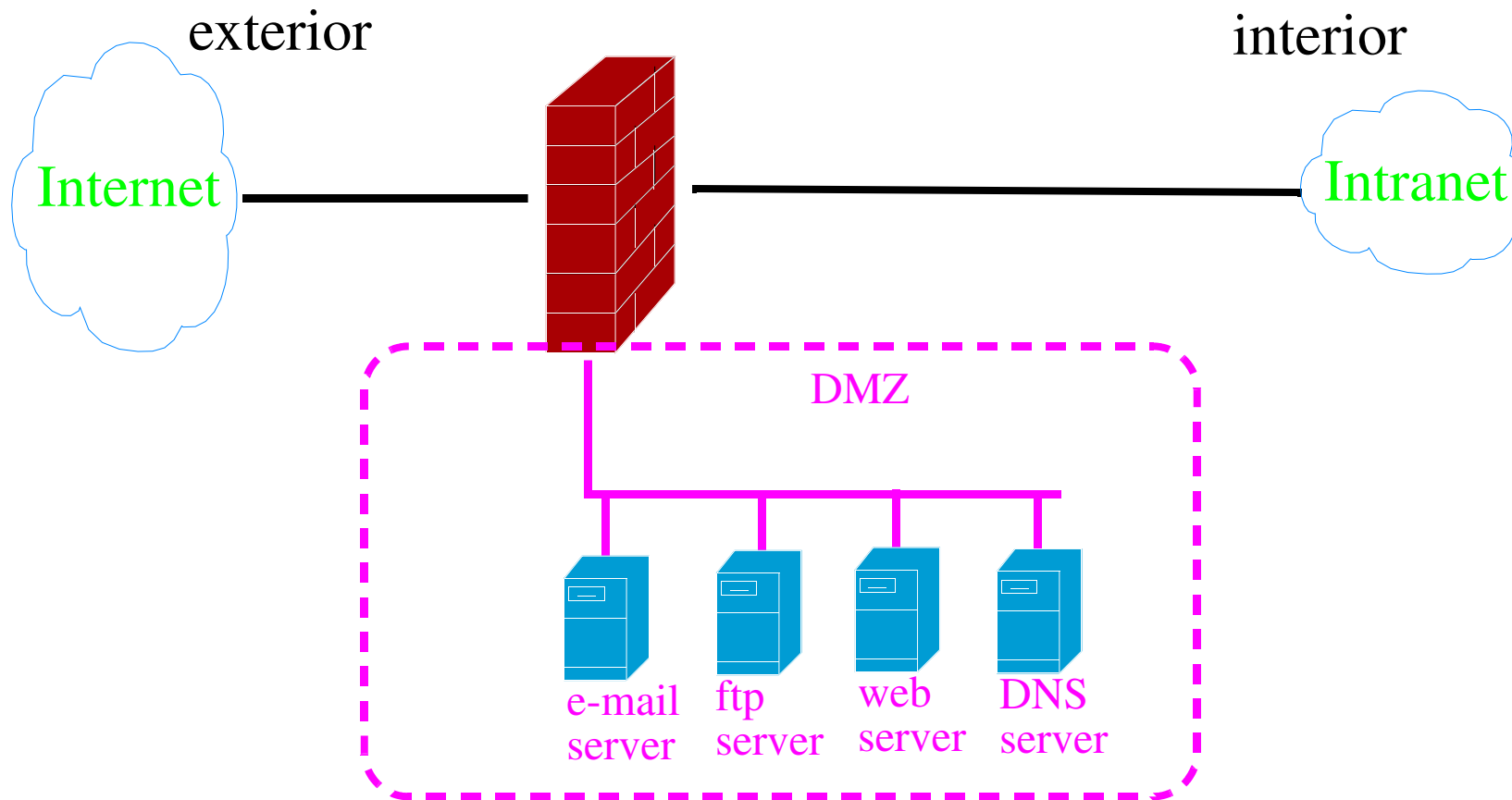

Figure 10: Example of a Firewall with a DMZ

Note that the various services may also be in different DMZ (see for example figure 4 page 90 of [20])

# Network Security Exercises

You will find a nice set of exercises by Ramesh Govindan at USC's ISI for Kerberos, S/Key, and firewalls at: <http://www.isi.edu/~govindan/cs558/netsec/index.html>

Note that you should **not** use their machines for these exercises, but I think you will find this useful reading.

# Security Organizations and Companies

Computer Emergency Response Team (CERT<sup>®</sup>) Coordination Center [10]

- 1988 - Computer Emergency **Response** Team
- 2003 - Computer Emergency **Readiness** Team [14]

Additionally, there are numerous other CERTs:

- CanCERT™, GOVCERT.NL, Sveriges IT-incidentcentrum (SITIC)  
<http://www.sitic.se/>, Centre d'Expertise Gouvernemental de Réponse et de Traitement des Attaques informatiques (CERTA), CNCERT/CC [14], ...
- The European Computer Security Incident Response Team Network  
<http://www.ecsirt.net/>

Forum of Incident Response and Security Teams (FIRST), now: 170 members [11]

NIST Computer Security Resource Center [12], Swedish Defense Material Administration, Electronics Systems Directorate [13], ...



# Summary

This lecture we have discussed:

- Private networks
- IPSec
- Firewalls

# Further information

- [1] IETF Security Area <http://sec.ietf.org/>
- [2] S. Kent and R. Atkinson, “IP Encapsulating Security Payload (ESP)”, IETF RFC 2406, November 1998  
<http://www.ietf.org/rfc/rfc2406.txt>
- [3] S. Kent and R. Atkinson, “IP Authentication Header”, IETF RFC 2402, November 1998  
<http://www.ietf.org/rfc/rfc2402.txt>
- [4] D. Maughan, M. Schertler, M. Schneider, and J. Turner, “Internet Security Association and Key Management Protocol (ISAKMP)”, IETF RFC 2408, November 1998 <http://www.ietf.org/rfc/rfc2408.txt>
- [5] D. Piper, “The Internet IP Security Domain of Interpretation for ISAKMP”, IETF RFC 2407, November 1998  
<http://www.ietf.org/rfc/rfc2407.txt>
- [6] H. Orman, “The OAKLEY Key Determination Protocol”, IETF RFC 2412, November 1998  
<http://www.ietf.org/rfc/rfc2412.txt>
- [7] D. Harkins and D. Carrel, “The Internet Key Exchange (IKE)”, IETF RFC 2409, November 1998  
<http://www.ietf.org/rfc/rfc2409.txt>
- [8] J. Linn, “Generic Security Service Application Program Interface, Version 2”, IETF RFC 2078, January 1997,  
<http://www.ietf.org/rfc/rfc2078.txt>
- [9] J. Wray, “Generic Security Service API Version 2 : C-bindings”, IETF RFC 2744, January 2000  
<http://www.ietf.org/rfc/rfc2744.txt>
- [10] Computer Emergency Response Team <http://www.cert.org/>
- [11] Forum of Incident Response and Security Teams <http://www.first.org/>
- [12] U. S. National Institute of Standards and Technology (NIST), Computer Security Division, Computer Security Resource Center  
<http://csrc.nist.gov/>

- [13] Swedish Defense Material Administration <http://www.fmv.se/>
- [14] David Crochemore, “Response/Readiness: What R the new CERTS?”, National Computer network Emergency Response technical Team/Coordination Center of China (CNCERT/CC) 2005 Annual Conference, Guilin, P.R.China, 30 March 2005  
<http://www.cert.org.cn/upload/2005AnnualConferenceCNCERT/1MainConference/10.DavidCrochemore-NGCERTOI.pdf>
- [15] Centre d’Expertise Gouvernemental de Réponse et de Traitement des Attaques informatiques (CERTA)  
<http://www.certa.ssi.gouv.fr/>
- [16] M. Leech, M. Ganis, Y. Lee, R. Kuris, D. Koblas, and L. Jones, “SOCKS Protocol Version 5”, IETF RFC 1928, March 1996  
<http://www.ietf.org/rfc/rfc1928.txt>
- [17] P. McMahon, “GSS-API Authentication Method for SOCKS Version 5”, IETF RFC 1961, June 1996  
<http://www.ietf.org/rfc/rfc1961.txt>
- [18] Postfix <http://www.postfix.org>
- [19] U.S. DOE’s Computer Incident Advisory Capability <http://ciac.llnl.gov/ciac/ToolsUnixNetSec.html>
- [20] Robert Malmgren, *Praktisk nätsäkerhet*, Internet Academy Press, Stockholm, Sweden, 2003, ISBN 91-85035-02-5
- [21] Charlier Kaufman, Radia Perlman, and Mike Speciner, *Network Security: Private Communication in a PUBLIC World*, Prentice-Hall, 1995, ISBN 0-13-061466-1
- [22] Simson Garfinkel, *PGP: Pretty Good Privacy*, O’Reilly & Associates, 1995 ISBN 1-56592-098-8
- [23] Internet Mail Consortium, “S/MIME and OpenPGP”, Oct 15, 2004 <http://www.imc.org/smime-pgpmime.html>

## Firewalls

- [24] Bill Cheswick and Steve Bellovin, *Firewalls and Internet Security: Repelling the Wily Hacker*, Addison Wesley, 1994,ISBN: 0-201-63357-4
- [25] D. Brent Chapman and Elizabeth Zwicky, *Building Internet Firewalls*, O’Reilly, 1995,ISBN: 1-56592-124-0
- [26] Tony Mancill, *Linux Routers: A Primer for Network Administrators*

Prentice-Hall, 2001, ISBN 0-13-086113-8.

[27] Firewalls mailing list <http://www.isc.org/index.pl?/ops/lists/firewalls/>

[28] Computer Security Institute (CSI) at <http://www.gocsi.com/>

## NAT

[29] P. Srisuresh and K. Egevang, “Traditional IP Network Address Translator (Traditional NAT)”, IETF RFC 3022, January 2001  
<http://www.ietf.org/rfc/rfc3022.txt>

[30] G. Tsirtsis and P. Srisuresh, “Network Address Translation - Protocol Translation (NAT-PT)”, IETF RFC 2766, February 2000  
<http://www.ietf.org/rfc/rfc2766.txt>

# IK1550 Internetworking/Internetteknik

## Spring 2010, Period 4

### Module 13: Future and Summary

Lecture notes of G. Q. Maguire Jr.



KTH Information and  
Communication Technology

© 2010 G.Q.Maguire Jr. .

All rights reserved. No part of this course may be reproduced, stored in a retrieval system, or transmitted, in any form or by any means, electronic, mechanical, photocopying, recording, or otherwise, without written permission of the author.

Last modified: 2010.03.21:17:37

# Outline

- Third generation of networking
- QoS
- Interface trends
- IP SANs (Storage Area Networks): iSCSI, ...
- A glimpse into the future.

# Generations of technology versus generative technology

Today there are lots of discussion of future communication systems, such as the cellular variants Theo Kanter calls  $\pi$ G systems<sup>1</sup>, next generation internet, ... . There is even discussion of **if** there will be a 4th **generation** of cellular systems or **if** we will see the end of *generational* architectures and systems.

For some additional insights on the future of networking, see Patrik Fältström's "Future of the Internet"[5] and Jonathan Zittrain's *The Future of the Internet -- And How to Stop It* [6] (see <http://futureoftheinternet.org/> ).

Note that Jonathan Zittrain's book focuses on the fact that upto this point the Internet can be seen as a **generative system/technology** (i.e., provides high **leverage**, is highly **adaptable**, is **easy to master**, the technology and tools are readily **accessible**, and there is high **transferability** {developments can easily be transferred to another user}) - see [6], page 70-73.

---

1. Because  $3 < \pi < 4$  and  $\pi$  is an irrational number.

# Third generation of networking

Van Jaconson describes the three generations as:

- "Generation 1: the phone system - focus on the wires.
- Generation 2: the Internet - focus on the machines connected to the wires.
- Generation 3? dissemination - focus on the data flowing between the machines connected to the wires."

-- slide 2: "A Brief History of Networking" of  
Van Jacobson, "If a Clean Slate is the solution what was the problem?",  
Stanford Clean Slate Seminar, February 27, 2006

<http://cleanslate.stanford.edu/seminars/jacobson.pdf>



# Dissemination not conversation

On slide 17 of the same talk, Van Jacobson states:

- "The raison d'être of today's networking, both circuit switched and TCP/IP, is to allow two entities to have a conversation.
- The overwhelming use (>99% according to most measurements) of today's networks is for an entity to acquire or distribute named chunks of data (like web pages or email messages).

Acquiring named chunks of data is not a conversation, its a *dissemination* (the computer equivalent of "Does anybody have the time?")"

-- slide 17 of

Van Jacobson, "If a Clean Slate is the solution what was the problem?",  
Stanford Clean Slate Seminar, February 27, 2006

<http://cleanslate.stanford.edu/seminars/jacobson.pdf>

# From PANs to RANs and beyond

The communication range of users - range from  $\sim 10^{-3}$  m to  $\gg 10^6$  m:

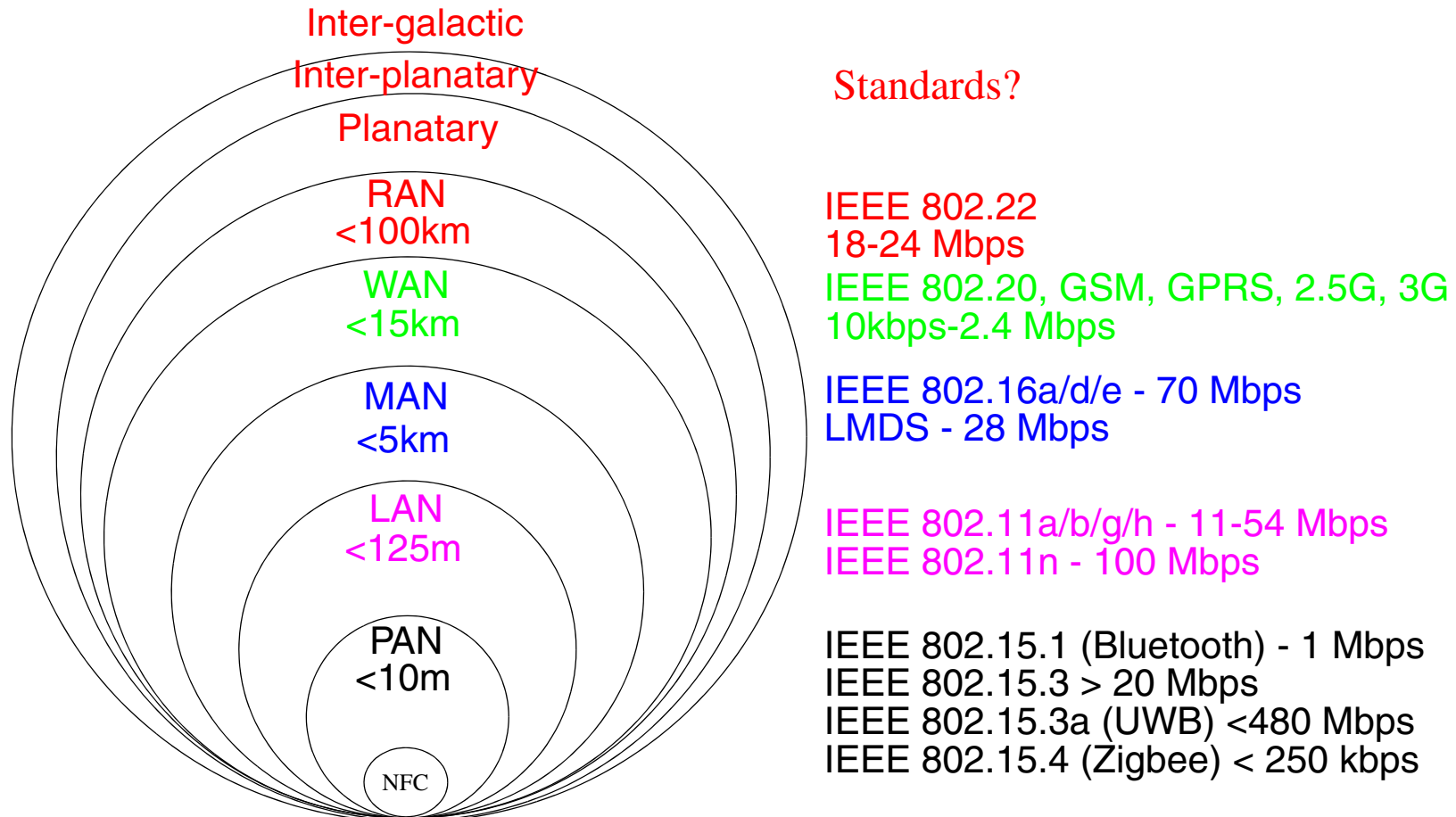

Figure 1: From Personal Area Networks (PANs) to Regional Area Networks (RANs) inspired by slide 5 of [24].

⇒ This implies that solutions will involve **heterogeneous** networks.

# Are interplanetary and intergalactic networks relevant to you?

- 1 Some customers: NASA, ESA, ... ; but also scientists/astronomers who want to look back in time
- 2 Future space explorers & tourists?
- 3 ⇒ **delay tolerant networks** (DTNs) - since the one-way delays are very high - perhaps this offers insights into other DTNs
  - For example, content distribution by the physical movement of “carriers” near to someone who wants the content or someone who will pass it on (and on and on and on!)
- 4 The communication is going to have to remain **uncorrupted for a very long period of time** (<http://www.digitalpreservationeurope.eu/>)
  - Note the Austrian goal of preserving digital documents for 200 years; this is much harder than just copying the bits from one media to another, but also includes issues such as the validity period for a digital signature (for authentication) or encryption (for privacy) and how these properties can be extended for much longer periods of time
  - Who is going to provide this storage/archiving/ ... ?
  - Who is going to transfer the “documents” to and from the storage repository (repositories)?

# Delay Tolerant Networks (DTNs)

Traditional applications generally assumed that to some degree there was:

- (1) end-to-end connectivity, (2) low round trip time, and
- (3) access to naming/caching/searching/... infrastructures.

Delay Tolerant Networks do not require these assumptions, thus nodes can communicate using an **opportunistic exchange of messages** (think of the messages as a propagating virus - moving from host to host)  $\Rightarrow$  **epidemic routing** protocols[15].

Key issues include [16]:

- What application layer data units are bundled into the DTN-layer protocol bundles for transport?
- Actual mobility patterns (social networks, commuting patterns, ... )

Metrics include [16]: Delivery ratio, Delivery Delay, and Delivery Cost

# Trends: Shifting from traditional telecommunications to data communications

This is often referred to as the shift to "All-IP" networking.

This embodies:

- A shift from **circuit-switched** to **packet-switched**
  - such as: from Intelligent network (IN) to IP Multimedia Core Network Subsystem (IMS)
- Introduction of new technologies:
  - Voice over IP (VoIP)
  - Number portability
  - Context-awareness (including location-awareness) in services
- From services being what the **telecommunication operator** offers *to you* to what **anyone** offers to you. This is accompanied by a major shift in:
  - How services are created
  - Where services are provisioned
  - Where data is stored and who stores it
- Desperate efforts to retain **control, market share, high profits, access to dial numbers, and call contents, ...** - the genie is reluctant to go back into the bottle!

# Growth rates

$n$  = number of users

Sarnoff's Law: value of a **broadcast** network  $\propto n$

- purely linear growth in the number of “viewers”

Metcalf's Law: value of a **communication** network  $\propto n*(n-1) \cong (n)^2$

- represents the possibility of each user to choose who they want to communicate with

Briscoe, Odlyzko, and Tilly propose[7]: value of a network  $\propto n \log(n)$

- they claim this is a better guide for investors and developers
- less than quadratic, but it is still far greater growth than linear!

Reed's Law: value of a network  $\propto 2^n$

- in networks that enable **groups** to form, the value goes up with the number of groups which can form {This is why **social networks** can be very important to networking.}

So if Briscoe, Odlyzko, and Tilly are correct that “Metcalf's Law is wrong”[7] - then **what is the growth law which is relevant to you?**

# Visualizing these laws

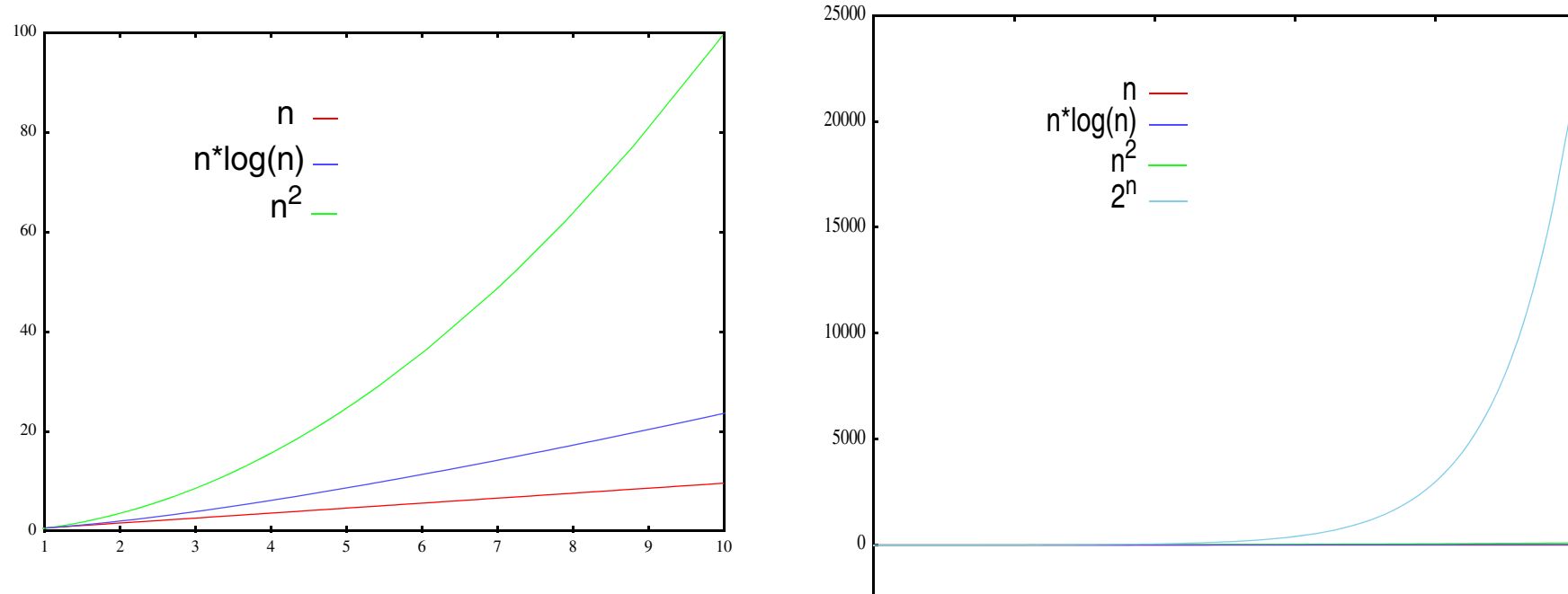
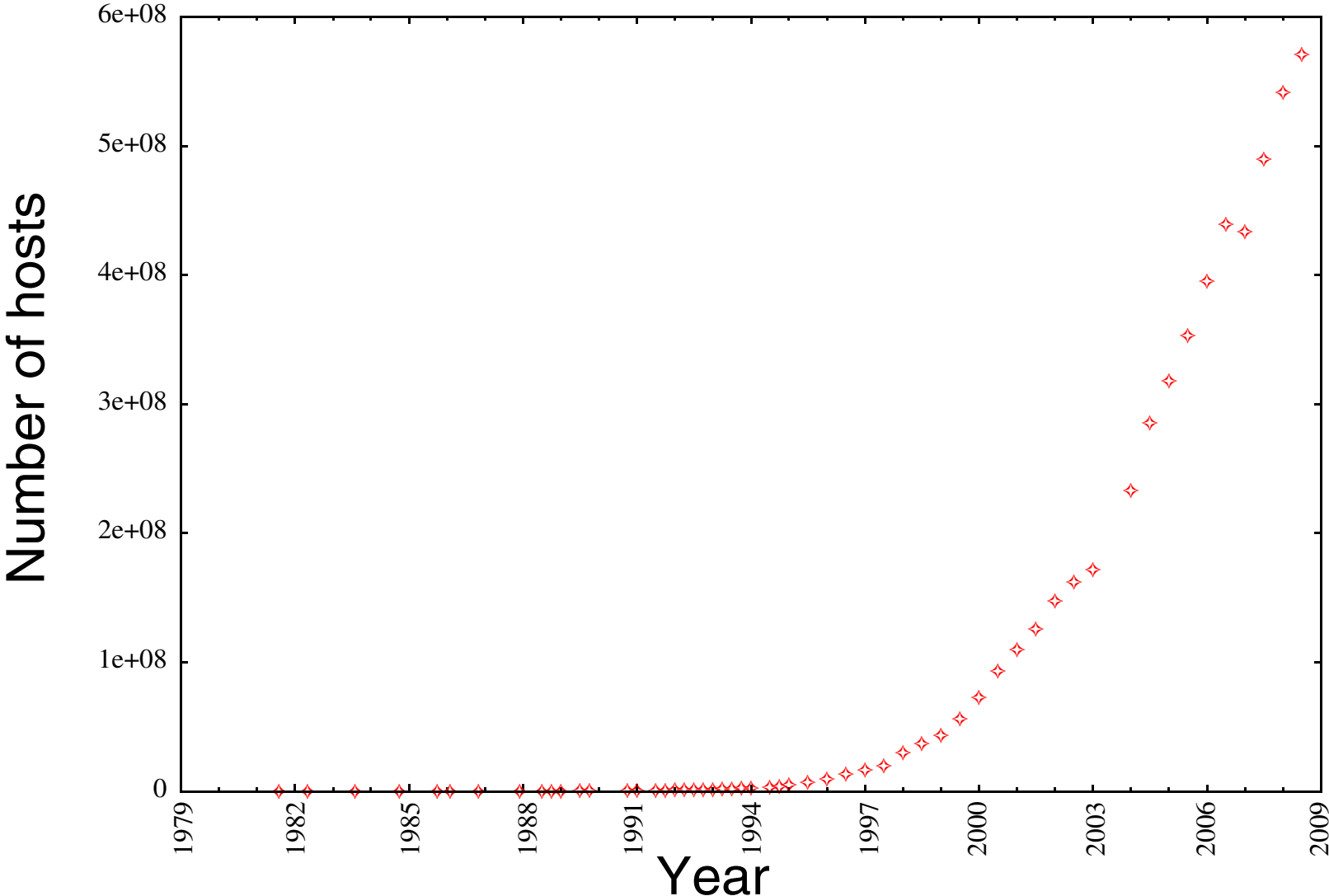

Figure 2: linear,  $n \log n$ ,  $n^2$ , and  $2^n$

It is important to not simply think and act **linearly** (The Lewis model of Cultural types [8]: linear active vs. multi-active vs. reactive). Note that Lewis has extended this model to include **context**[9].

# Growth in Internet hosts



Data from <https://www.isc.org/solutions/survey/history>



# Exponential growth

As Ray Kurzweil points out in Chapter 1 of his book, *The Singularity Is Near* [10], the law of accelerating returns implies that the rate of change is increasing<sup>1</sup>.

Up close exponential change is not much different from linear change, but step back slightly and we see there is a very big difference (see our earlier plot on the right in Figure 2). For information technologies he states that the growth rate is exponential, and that is the exponent is increasing and not simply a constant.

He predicts that the 5<sup>th</sup> Epoch involves the merger of technology and human intelligence and that by the end of the 2020s a computer will pass the Turing test. If this is the case, then shortly computers will combine the strengths of both human and machine intelligence -- What does this imply about services?

With Google being on a trajectory to having all information available on-line and offering on-line services with nearly unlimited storage for ~\$2/year. What is next?

---

1. Irving Wladawsky-Berger makes this same point regarding the commoditization of computing in the cloud [31].

# Long tail

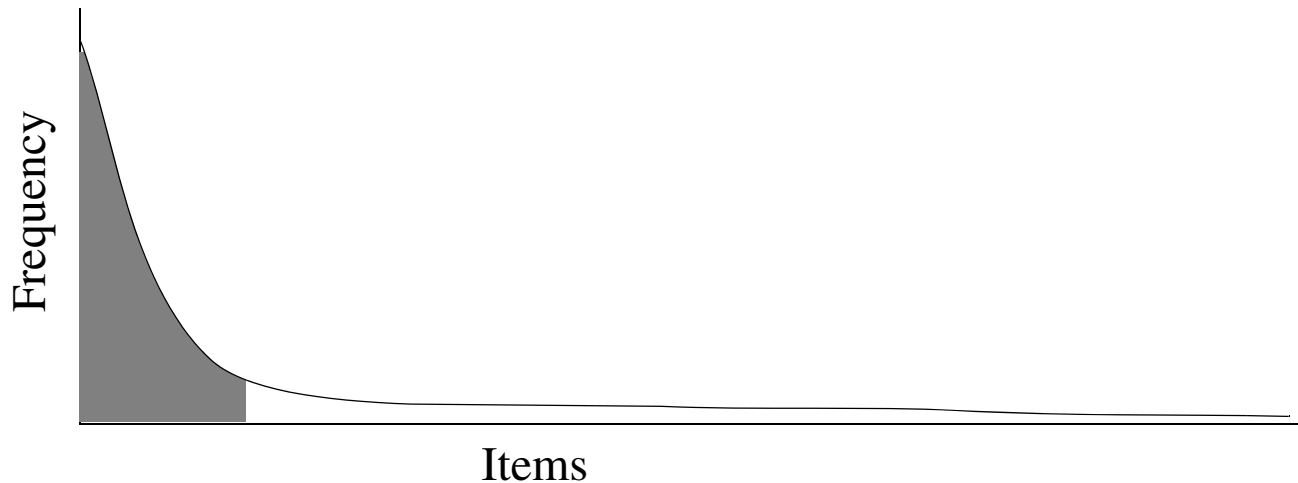

Figure 3: Long tail distribution

Book stores stock books that they expect to sell at least one of per year, but Amazon.com has near zero cost of "shelf space" - so they sell well into the tail!

Chris Anderson's *The Long Tail: Why the Future of Business Is Selling Less of More* [34] and his earlier article in *Wired Magazine* discussed the power law relationship between the volume of sales ( $r^{-\beta}$ ) and a product's rank ( $r$ ); with a  $\beta$  of 1.214, the sales hits are ~20% of 100 offerings, but 80% of the sales but as the number of unique items increases the market share shifts from the head of the distribution to the tail (i.e., there is more money in the **sum of the sales from the tail** than from the head)<sup>1</sup>, see <http://www.thelongtail.com/>

1. See <http://demonstrations.wolfram.com/TheLongTail/> for an interactive demo

# Is this only true for books?

Chris Anderson's blog of 2 October 2009 "The long Tail of Travel"<sup>1</sup>, presents research done by Maren Jinnett using data compiled by the UK's Civil Aviation Authority - travel to top 50 flat, but growth in the tail.

You can find Maren Jinnett's spreadsheet at: <http://www.longtail.com/long%20tail%20of%20travel.xls>

Chris Anderson's hypothesizes:

- " \* Lowered flight costs = more travel, more risk-taking
- \* Lower "search costs" = broader vistas, more willingness to go off the beaten path
- \* Better word-of-mouth tools = "bottoms-up hits"
- \* Peer ratings, reviews reinforce authentic success, punish "manufactured experience" "

---

1. <http://www.thelongtail.com/>

# Free

Chris Anderson's *Free: The Future of a Radical Price* [35] discusses how businesses can make money in an age when lots of things are free (i.e., a price of \$0.00)

A key insight is that in the **digital** economy, when the "margin cost" is near zero, **then round down to zero.**

⇒ Feeconomics

⇒ Freemium (a free version and a matching premium version)

He gives interesting example of how air travel can be free (pg. 19), how a DVR can be free (pg. 21), how everything in a store can be free (pg.60), how a car can be free (pg.81), healthcare (pg. 104), trading stocks (pg. 113), webmail (pg. 115), an exclusive conference (pg. 117), directory assistance (pg. 122), silverware (pg. 141), music CDs (pg. 155), textbooks (pg. 160), university education (pg. 185), and second hand goods (pg. 188).

# Too cheap to meter

"It is not too much to expect that our children will enjoy in their homes **electricity too cheap to meter**, -- will know of great periodic regional famines in the world only as matters of history, -- will travel effortlessly over the seas and under them and through the air with a minimum of danger at great speeds, -- and will experience a lifespan far longer than ours as disease yields and man comes to understand what causes him to age."

-- Lewis L. Strauss, Chairman of the U.S. Atomic Energy Commission  
In an address to the National Association of Science Writers  
16 Sept. 1954

Today three other technologies are approaching the too cheap to measure point:

- computing power
- digital storage
- communication bandwidth

⇒ faster, better, cheaper -- a "triple play" for on-line services

# Working for free

Once you have food, shelter, ... (Maslow's subsistence needs<sup>1</sup>) people move on to social needs, esteem needs, and "self-actualization" - using their **cognitive surplus** (the energy and knowledge that isn't used for your "job")- page 189 of [35]

Hence the importance of:

- community
- visibility
- because I like to do it ("fun")

These are driving forces behind open source software/hardware, web pages, social networks, Wikipedia, ... .

See Andrew Lih, *The Wikipedia Revolution: How a Bunch of Nobodies Created the World's Greatest Encyclopedia* [36]

---

1. "Hierarchy of Needs": physiological, safety, social, esteem, self-actualization; see Abraham H. Maslow, *Motivation and Personality*, Harper 1954

# What Would Google Do?

Jeff Jarvis' *What Would Google Do?* (WWGD) [37] explores re-thinking how you do business by [finding a new world view](#) and [seeing things differently](#)

The book is not about what would Google as a business do, but rather what seeing the world as Google sees it - then [thinking differently](#) about solving problems could do<sup>1</sup>.

Rather than thinking about "Will it make money?", start with:

- Will users think it is cool?
- Will it scale to support 100 million users?
- Is there a positive feedback cycle as it grows?

See [Buzzmachine.com](http://buzzmachine.com) for more about the book

For a counterpoint see:

Ken Auletta, *Googled: The End of the World as We Know It* [38] (and the review [39])

---

1. I refer to it as "enlighted self-interest"

# Quality of Service (QoS)

QoS refers to statistical performance guarantees that a network can make regarding packet loss, delay, throughput, and jitter.

Best effort delivery means no QoS guarantee.

QoS is thought to be more and more important these days.

Many proposals, implementations and studies.

Does Internet need QoS? How can IP network provide it?



# Service Differentiation

Integrated Services (InteServ):

- RSVP: connection request
- All nodes IntServ-capable
- Scalability
- Complicated network management

Differentiated Service (DiffServ): end of one-size-fits-all

- Classes of Service
- QoS based Routing
- Classes of Service at Gigabit rates
- New Pricing and Billing Policies
- New Resource Allocation Methods

See: [1]

# Constraint-based Routing

QoS routing: selects network routes with sufficient resources for the requested QoS parameters

- to satisfy the QoS requirements for every admitted connection;
- to achieve network efficiency in resource utilization.

Policy-based Routing: e.g. Virtual Private Networks (VPN)

How can we combine this with IP mobility?

# Mobile *ad hoc* Networks (MANETs)

*Ad hoc* networks exploit the links which are **possible** with their neighbors

Mobile *ad hoc* networks (MANETs) exploit the fact that as nodes move the set of neighbors may change.

There may exist gateways between a MANET and fixed infrastructures - see for example the combination of **Mobile IP** and **MANETs** (MIPMANET)[11]

# Performance

## Routers:

1/2 to 1 Million packets per second (pps) for every gigabit per second of aggregate bandwidth

more than 250,000 routes

# PC interfaces

Standard I/O ports of PCs:

- Accelerated Graphics Port (AGP)
- PCI
  - Version 2.1 PCI bus - 64 bit, 66MHz, can burst to 528 Mbps
  - PCI-X 2.0: “High Performance, Backward Compatible PCI for the Future” [2]
  - PCI-X 533, offering up to 4.3 gigabytes per second of bandwidth
- Universal Serial Bus (USB)
  - USB: 12Mbps - with plug and play
  - USB 2.0 [3]
- Apple Computers' Firewire™ ⇒ IEEE 1394
  - supporting more than 400 Mbps
  - P1394B (Gigabit 1394) defined in IEEE Std 1394b-2002
- 10/100/1000 Ethernet

# Fibre Channel

From the X2T11 standards activity

Topologies: Point-to-Point, Fabric, and Arbitrated loop

Addresses: Loops, LANs, and worldwide addresses

Fibre Channel Profiles

Fibre Channel products

- Disk drives
- Network interfaces

# IP Storage Area Networks (SANs)

Using IP in conjunction with storage:

- Fibre Channel Over IP (FCIP)

JBOD == Just a Bunch of Disks

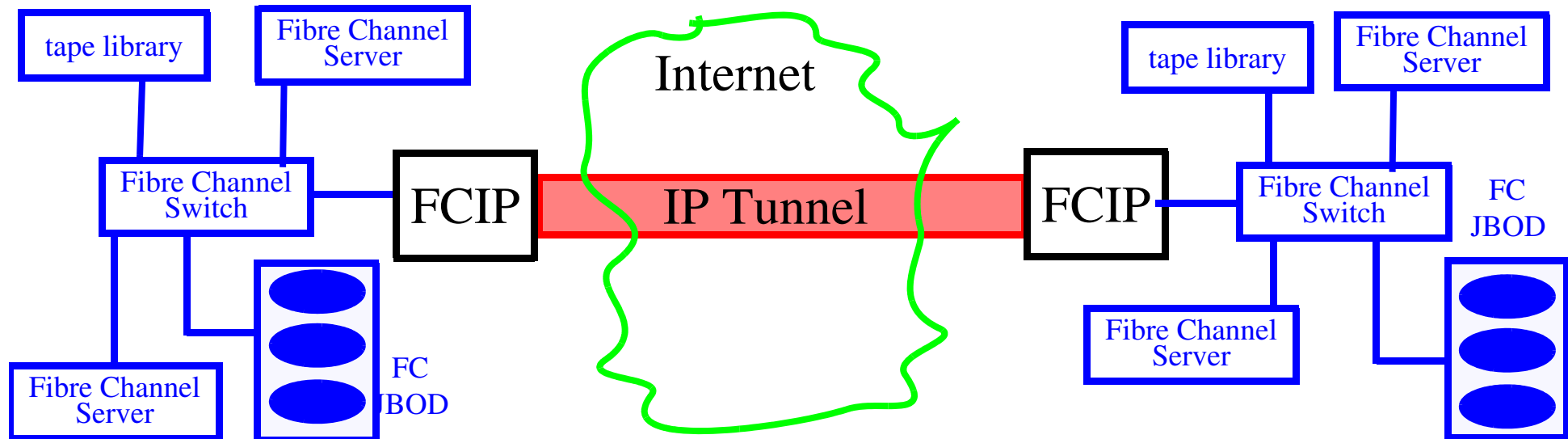

Note that this approach simply interconnects the two Fibre Channel switches. The connection between the two switches is TCP and it simply encapsulates a FCIP header and a Fibre Channel Frame.

- Internet Fibre Channel Protocol (iFCP)

JBOD == Just a Bunch of Disks

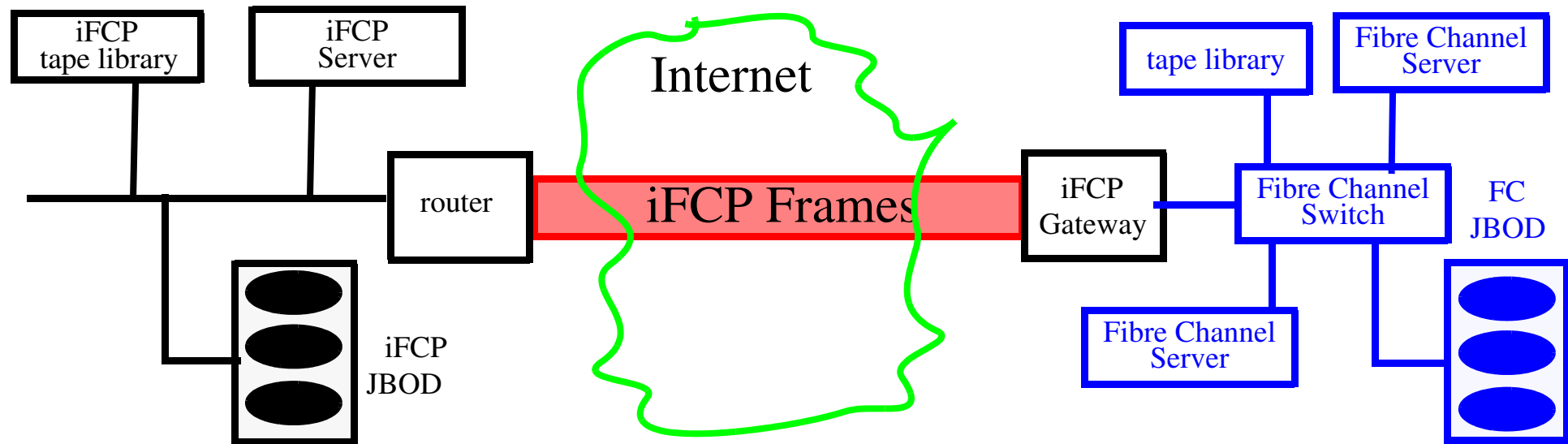

Note that this approach interconnects Fibre Channel devices. The connection between the two switches is TCP and it encapsulates a iFCP header and a Fibre Channel Frame; note that iFCP devices can simply be attached to the internet or an intranet. This means that there has to be a mapping between Fibre Channel addresses and IP addresses.



- Internet SCSI (iSCSI)

JBOD == Just a Bunch of Disks

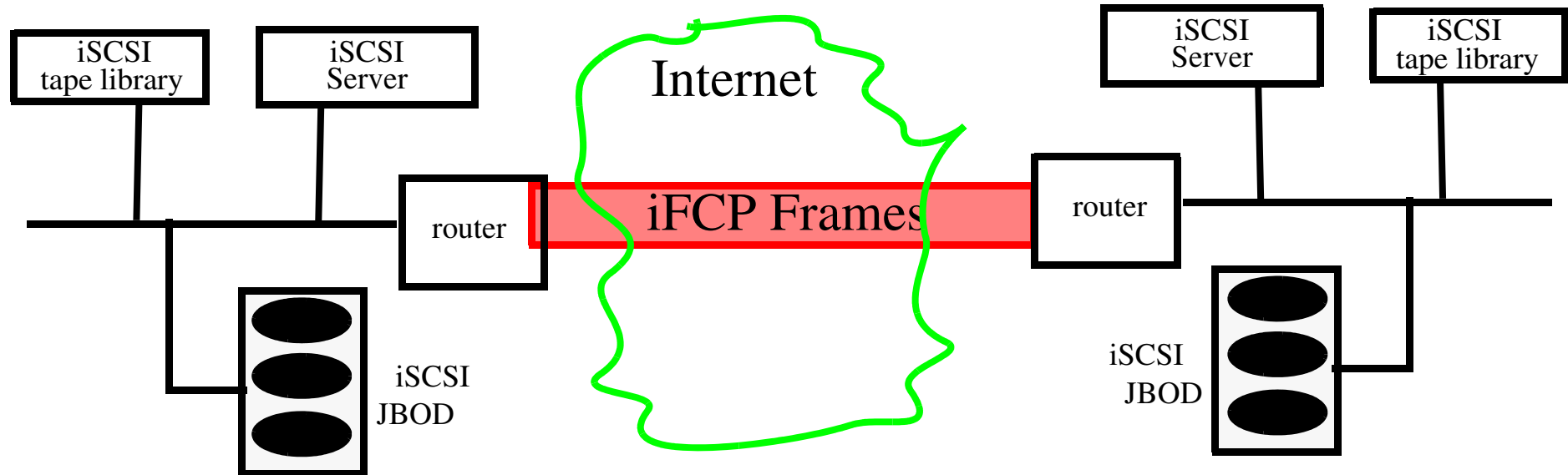

Once a SCSI initiator has logged-in to a SCSI target, it can simply issue SCSI commands, just as if the device were on a local SCSI chain!

For more information see [4]

# Clustering

Myricom, Inc. <http://www.myri.com/>

American National Standards Institute (ANSI) Standard -- ANSI/VITA 26-1998

- Started by
  - Prof. Charles L. Seitz - Caltech, now President and CEO
  - Dr. Robert Felderman - Director of Software Development
  - Mr. Glenn Brown - Engineer and programmer

Clusters used to form high performance servers, using commodity networks and hosts. For performance numbers see: <http://www.myri.com/myrinet/overview/>

# “Beowulf-class” machines

Using large numbers of commodity machines to make high performance computational systems by interconnecting them with a network.

- LANL's Loki <http://loki-www.lanl.gov>
- LANL's Avalon <http://cnls.lanl.gov/avalon/>
- JPL's Hyglac <http://hpc.jpl.nasa.gov/PS/HYGLAC/hyglac.html>
- INRIA's PopC (Pile of PCs)
- ...

# Very high-speed Backbone Network Service (vBNS)

vBNS project (<http://www.vbns.net/>) created to provide a backbone for the US high-performance computing users and their SuperComputer Centers.

- mostly OC12C, but now adding OC48C links (2.4Gbps)
- connections to all NAPs
- provide for multimedia services (provides multicast)
- participate in developing advanced routing technologies
- supports IPv4 and IPv6

vBNS backbone network (<http://www.stanford.edu/group/itss-cns/i2/vbns.html>)

There is some interest in using vBNS for inter-gigapop interconnections.

# Internet2

<http://www.internet2.org/>

- World class **research**  
Driven by computational physics, biology, chemistry, ... and scientific visualization, virtual “experiments”, and remote control of real experiments.
- Networking R&D - focused on exploiting the capabilities of broadband networks media integration, interactivity, real time collaboration, ...
- Improve **production** Internet services and applications for **all** members of the academic community, both nationally and internationally.

Purpose: support national research objectives, distance education, lifelong learning, and related efforts.

<http://www.hpcc.gov/white-house/internet/background.html>

# Gigapops

Who will be operating them?

Where will they be?

How many will there be?

What is the aggregate throughput that they will require?

What is the maximum per port throughput?

How many ports will they need to support?

Will they support "mixing"? (mixing is used to defeat traffic analysis)

Whose hardware and software will they use? What is the required functionality?

# Speed through Silicon

FPGAs used in many routers - for flexibility and to allow near hardware speed implementations of protocols.

ASICs: Vertex Networks, Inc. , MMC Networks, Inc, Galileo Technology, TI, ...

# Future networks

Terabit per second ==  $10^{12}$

Readily achievable via combining multiple Gigabit per second streams using Wavelength Division Multiplexing (WDM).

Petabit per second ==  $10^{15}$

Differentiated Services: Classes of Service, Multimedia

Constraint-based Routing (QoS Routing)

Ad Hoc Networking

Auto-configuration (Plug and Play Internet)

Active Networking

Smart Networking

Knowledge-based Networking



# Active Networks

- Network nodes can perform customized computations on the messages flowing through them.
- Can change, modify the contents of the messages.
- Potentially Mobility Enabling Routing using active network concept

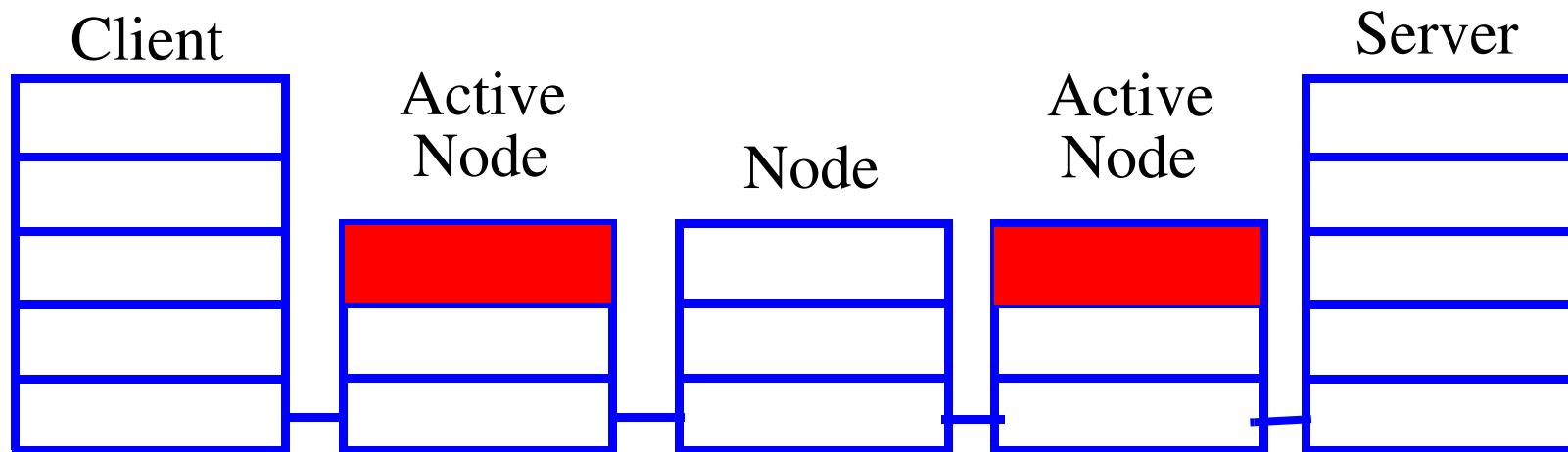

# Active networks

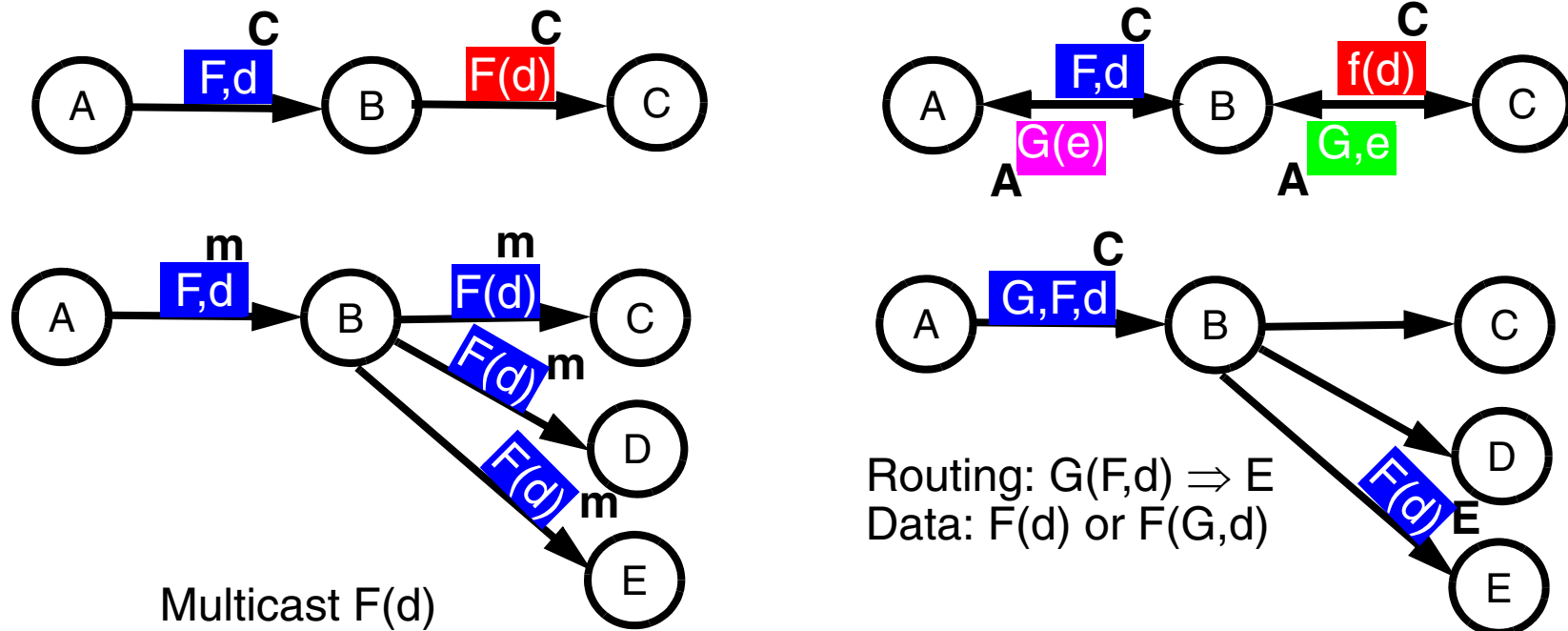

B acts as an intermediary between A and x:

- (1) **operates** on the **data** as it passes through using the “program” F and/or
- (2) **routes** based on the computed **address** using a “program” G

Packets carry the **program** that each node on the path is to execute.  
 {Even the program(s) can be transformed as the packet propagates.}

# Smart Networks with Sensors

(Ren and Maguire, KTH)

- Context/situation-aware Systems
- Smart services: active + user-awareness networking
- Knowledge-based Networking

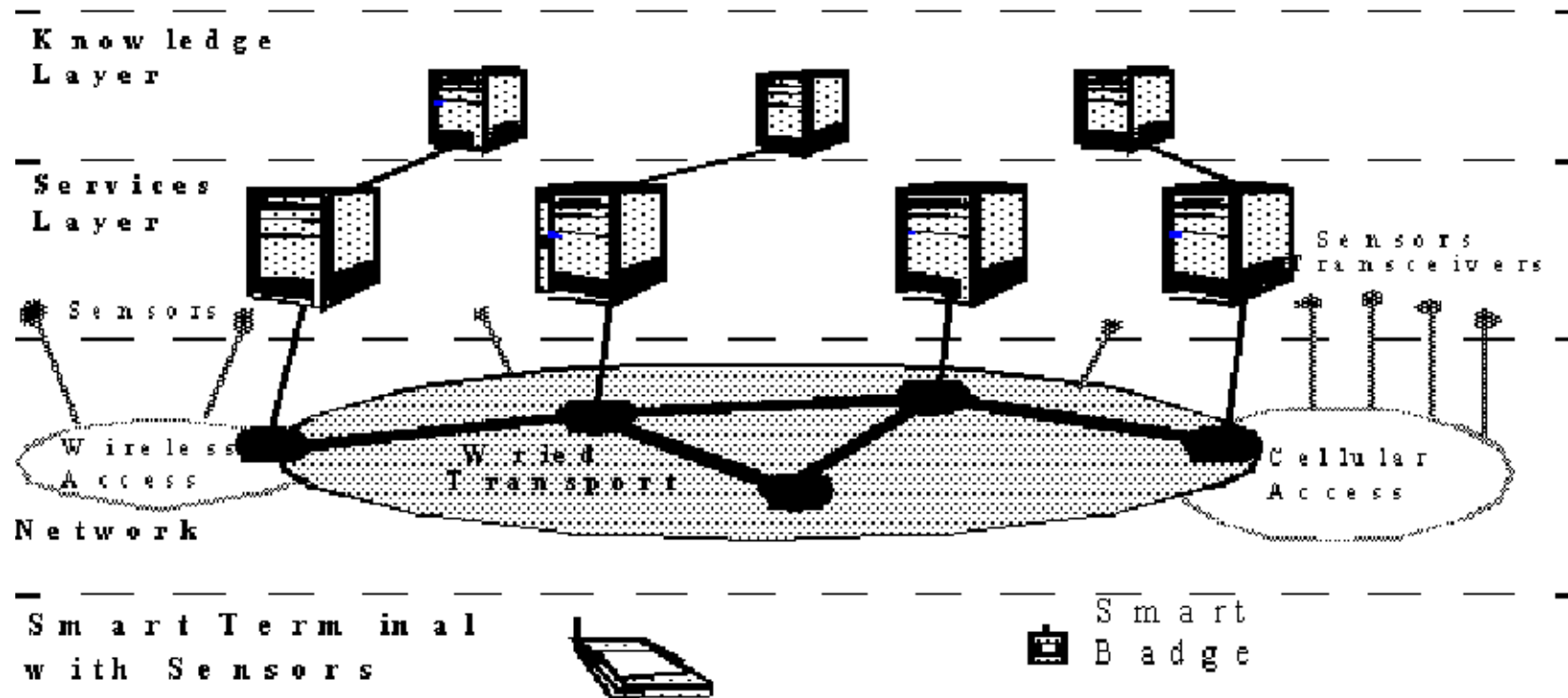

# Internetworking as the future?

Now that internetworking technology is well on its way to wiping out the traditional industries, such as:

- Voice telephony operators
- Newspaper & magazine publishers
- Scientific journal publishers
- Record Companies, Movie distributors, ...
- ...

What comes next?

# Future of the Internet

An important part of the success of the current internet is the engineering design decision to make the network “**stupid**” - thus the intelligence is in the endpoints and not in the core network (the exact opposite of traditional telephony networks).

⇒ end-to-end principle [4]

This end-to-end principle has driven both innovation and policy (see for example [12] and current arguments regarding “*network neutrality*”).

See the EU’s Future of the Internet efforts at <http://www.future-internet.eu> and [13]

# Counter currents

However, there are forces working against innovation and openness:

- Major efforts to avoid **network neutrality** (<http://opennet.net/>)
- **Walled gardens & tethered devices**
- Built-in **kill switches** or remote reconfiguration - **not** under the control of the user
- **Legal action** or threats thereof (see <http://www.chillingeffects.org/> )
- **Filtering** (including national filtering) [14]
- ...

Jonathan Zittrain's recent book: *The Future of the Internet -- And How to Stop it* offers a technical, legal, policy, and social view of the future of the Internet and why “tethered appliances” ends the tradition of a generative system (which have the ability to “**produce unanticipated change** through unfiltered contributions from broad varied audiences”[6]) potentially leading to ending the cycle of innovation which has driven the success of the Internet.

# Clean slate re-design of the Internet

Many have questioned one or more of the basic concepts and currently several groups are attempting to do a clean slate re-design of the Internet.

Consider for example the two research questions that researchers at Stanford University are asking as part of their Clean Slate program:

- "With what we know today, if we were to start again with a clean slate, how would we design a global communications infrastructure?", and
- "How should the Internet look in 15 years?"

-- Quoted from <http://cleanslate.stanford.edu/>

See also: [http://cleanslate.stanford.edu/about\\_cleanslate.php](http://cleanslate.stanford.edu/about_cleanslate.php)

This is only one of many such projects, see also:

- U. S. National Science Foundation GENI: <http://geni.net>
- European Union Future Internet Research and Experimentation (FIRE): <http://cordis.europa.eu/fp7/ict/fire/>

# Implicit vs. Explicit Information

Van Jacobson expresses this as:

- "The nice properties of packet switching result from moving source & destination information *implicit* in a circuit switch's time slot assignments into *explicit* addresses in the packet header. (But its easy to do this wrong, e.g., ATM.)
- The nice properties of dissemination result from making the time & sequence information *implicit* in a conversation be *explicit* in a fully qualified name."

-- slide 26: "Digression on Implicit vs. Explicit Information" of

Van Jacobson, "If a Clean Slate is the solution what was the problem?",  
Stanford Clean Slate Seminar, February 27, 2006

<http://cleanslate.stanford.edu/seminars/jacobson.pdf>

The emphasis (in *italic red characters*) in the above quotation were added by Maguire.



# Is an hourglass the right model?

Rui L. Aguiar argues that perhaps it is **two** hourglasses - one for data and one for control. His argument is based upon **per flow** or aggregate processing *versus* **per packet** processing - for details see [17].

# Peer to peer networking

Lots of the ideas that were covered also apply to other settings, for example - consider peer-to-peer networks for distributing entertainment multimedia content. These can use the caching of user's machines to provide the storage and can **exploit the bandwidth within the distribution network** to reduce the ISPs costs for peering!

See these Masters theses:

Cao Wei Qiu, *A new Content Distribution Network architecture - PlentyCast*[18]

Ayodele Damola, *Peer to peer networking in Ethernet broadband access networks*[19]

Athanasios Makris and Andreas Strikos, *Daedalus: A media agnostic peer-to-peer architecture for IPTV distribution*[20]

# Wikinomics

Don Tapscott and Anthony D. Williams in their book *Wikinomics: How mass Collaboration Changes Everything* [21] point to cooperation in the form of “peer production” - where massive collaboration drives innovation.

Examples:

- open source software: linux, gcc, ...
- wikis: Wikipedia
- blogs: blogosphere
- prosumers: “cocreating goods and services rather than simply consuming the end product” ([21], p. 1)
- gaming: Second Life, ...
- peer-to-peer services: Skype, BitTorrent, ...
- Web 2.0 + social networking: Flickr, YouTube, Facebook, MySpace, ...
- e-science: Human Genome, the Goldcorp Challenge<sup>1</sup>, ...

---

1. <http://www.goldcorpchallenge.com/> - a gold mining company that put its proprietary data on-line and made it accessible to the public with a total of US\$575,000 in prizes ⇒ 6 million ounces of gold Red Lake Mine in Ontario, Canada as a result!

# Resource pooling

Damon Wischik, Mark Handley, and Marcelo Bagnulo Braun in their article “The Resource Pooling Principle” [22] define **resource pooling** as:

“Resource pooling means making a collection of networked resources behave as though they make up a single pooled resource. The general method of resource pooling is to build mechanisms for shifting load between various parts of the network.”

They go on to make two observations:

- 1 “Resource pooling is often the only practical way to achieve **resilience** at acceptable cost.”
- 2 “Resource pooling is also a **cost-effective** way to achieve flexibility and high utilization.”

# Resource pooling examples

Resource pooling can be used for:

- sharing lines/links/sites
- sharing storage
- computing power

This leads to **grid computing**, **computing clouds**, ...

Consider the proposal for Green IT by Bill St. Arnaud of Canada's CANARIE:

<http://green-broadband.blogspot.com/> - put server farms in places with local renewable energy supplies - then move the bits to/from the user

⇒ moving **Gigabits/second vs. Gigawatts**

This implies the use of **dense wavelength division multiplexing (DWDM)** over optical fibers from these (often remote) sites to where the users are.

# Context of the module

Personal communication systems have been both increasing their **number of users** and **increasing the variety** of personal communication systems. Additionally, increasingly communicating entities are ***not*** people, but rather **things**.

|                     | Number                            |   |
|---------------------|-----------------------------------|---|
| Micro controllers   | $6 \times 10^9$ per year          | <a href="http://doi.ieeecomputersociety.org/10.1109/MM.2002.10015">http://doi.ieeecomputersociety.org/10.1109/MM.2002.10015</a>   |
| People              | $6.7 \times 10^9$                 | <a href="http://en.wikipedia.org/wiki/World_population">http://en.wikipedia.org/wiki/World_population</a>   |
| Mobile subscribers  | $\sim 4 \times 10^9$              | <a href="http://www.itu.int/ITU-D/ict/newslog/Worldwide+Mobile+Cellular+Subscribers+To+Reach+4+Billion+Mark+Late+2008.aspx">http://www.itu.int/ITU-D/ict/newslog/Worldwide+Mobile+Cellular+Subscribers+To+Reach+4+Billion+Mark+Late+2008.aspx</a> |
| PCs                 | $> 1 \times 10^9$                 | <a href="http://www.gartner.com/it/page.jsp?id=703807">http://www.gartner.com/it/page.jsp?id=703807</a>   |
| Automobiles         | $53 \times 10^6$ produced in 2007 | <a href="http://oica.net/category/production-statistics/">http://oica.net/category/production-statistics/</a>   |
| Commercial vehicles | $20 \times 10^6$ produced in 2007 | <a href="http://oica.net/category/production-statistics/">http://oica.net/category/production-statistics/</a>   |

# What kinds of things might be interesting?

- **Personal monitoring**: for health, for sports, for law enforcement, to replace prisons, ...
- **Vehicles**: Vehicle Area Networks (VANs), Vehicular *ad hoc* networks (VANETs), ...
- **Packages**: logistics (tracking, routing, ...), monitoring of package - for temperature, pressure, acceleration/deacceleration, ..., transport security (has the package been tampered with), customs/law enforcement/...
- **Buildings**: Heating, Ventilation, and Air Conditioning (HVAC), minimizing energy waste while maximizing productivity, facilitating human & device location, avoiding theft/loss/floods/leaks/..., ...
- **Appliances**: Is the refrigerator working? Did I leave the stove on? Warm up the sauna/hot-tub/... I'm on my way home! ...
- **Infrastructure**: Is there ice on the bridge? Did the earthquake damage the bridge? ...
- **Environment**: air, water, oceans, land, ...

# Personal monitoring

Darwin Valderas Núñez recent MS thesis “Integration of sensor nodes with IMS” showed the ability for a coach to monitor a runner remotely via IMS [23].

However, the **delays** of IMS are so high as to make this approach impractical, but he could have simply used SIP + RTP (or SRTP) to stream the sensor data to the coach’s PC and had very low delay.



# Vehicle Area Networks (VANs)

Controller Area Network (CAN) bus within vehicle to interconnect sensors, actuators, and controllers  $\Rightarrow$  improved performance with a decrease in vehicle weight. Truck to trailer communication - extending the vehicular network to the trailer (or trailers) [24]

In vehicle entertainment - audio/video/gaming/... for passenger and audio for the driver.

Hands free voice telephony - as handheld cellular is banned in most countries

- Does the driver plug in their iPOD/phone/... and use the facilities of the vehicle?
- Does the vehicle incorporate the driver/passengers by extending/adapting itself for them?
- Does the vehicle adapt the output audio/video/... to the vehicles context (for example, the phone will not permit calls at high speed when there are lots of other cars within minimum breaking distance)?

# Vehicular *ad hoc* networks (VANETs)

VANETs are thought to facilitate a wide variety of applications (adapted from Table 1 of [25]):

- **Active safety**
  - Warning about dangerous road **features**: curves, height restrictions, upcoming intersections/bridges/tunnels/rail crossings/...
  - Warnings about traffic and road **conditions**: ice/water/... on road, potholes, work-zone, school-zone, ... congestion
  - Danger of collision: due to lane change, breaking of vehicles in front of you, ...
  - Pre-sensing crash
  - Assistance following a crash
- **Public service**
  - Facilitating movement of emergency vehicles and public transport
  - Support for authorities: tolls, fines, vehicle inspection, driver's license, ...
- **Improved driving**
  - Improving driving via various forms of assistance, heads up forward IR and rear views, heads up signage, ...
  - Traffic efficiency: updating traffic control centers with local conditions ⇒ advising driver of alternative routes, maps and navigation aids, guidance to available parking/gas station/restaurant/...
- **Business and entertainment**

- Vehicle maintenance: diagnostics, software updates, recalls, ...
- Mobile communication services: internet access, messaging, ...
- Enterprise solutions: fleet management, vehicle tracking (for rental vehicles and hazardous/valuable cargos), ...
- E-payment: tolls, parking, ...

Note that IEEE Communications Magazine, Volume 46, Number 11, November 2008 issue has several article on VANETs - including an excellent article discussing the requirements for [security](#) and [privacy](#) for VANETs [26].

# Packages

Logistics (tracking, routing, ...), monitoring of package - for temperature, pressure, acceleration/deacceleration, ..., transport security (has the package been tampered with), customs/law enforcement/...

Note that Qualcomm's first enterprise wireless service was a satellite-based mobile communications system for the transportation and logistics markets called OmniTRACS<sup>®</sup>.

Today the U.S. Homeland Security Department opens & inspects ~6 percent of the 11 million cargo containers that enter U.S.[27] - a new approach is to do inspection at port of origin, then ensure (electronically) that the container is not tampered with on the way.

Note: For many people the "Internet of Things" primarily concerns things with RFIDs attached - we will **not** limit our thoughts in this way.

# Buildings

Heating, Ventilation, and Air Conditioning (HVAC), minimizing energy waste while maximizing productivity, facilitating human & device location, avoiding theft/loss/floods/leaks/..., ...

- Half the cost of a HVAC system is the wiring from the sensors and actuators to the HVAC control system!
- Just how much electrical power/water/... am I using now?
- How much power am I **selling** to the grid?
- One of the greatest sources of losses for Swedish insurance companies is water leaks due to pipes bursting in cold weather - as the leak is not discovered in time to prevent a major loss. What is the value vs. cost of a simple leak detector?

# Appliances

- Is the refrigerator working?
- Did I leave the stove on?
- Warm up the sauna/hot-tub/... I'm on my way home! ...
-

# Infrastructure

- Is their ice on the bridge?
- Did the earthquake damage the bridge? ...

Wind and Structural Health Monitoring Systems (WASHMS), for example the New Svinesund Bridge in Sweden instrumentation consists of ([28] p. 5):

- 16 vibrating-wire strain gauges, 4 at arch base and 4 just below the bridge deck (on both Norwegian and Swedish sides)
- 8 resistance strain gauges (2 at arch base, 2 in a segment just below bridge deck, and 4 at the crown)
- 4 linear servo accelerometers, installed pair-wise as each new arch segments is construction; on completion 2 accelerometers moved to the arch mid point and 2 to the arch's Swedish quarter point
- 28 temperature gauges (in the same locations as the strain gauges)
- 1 outside air temperature gauge, and
- 1 3-directional ultrasonic anemometer for measuring wind speed and direction at deck level close to the first support on the Swedish side.

See <http://www.byv.kth.se/svinesund/index.htm>

The Rion-Antirion Bridge in Greece is monitored by Advitam in France - using 372 measurement channels via the internet[29].

# Environment

Monitoring air and water quality, food, ...

Monitoring for natural disasters: earthquakes, tsunamis, ...

Monitoring for man made disasters: fires, pollution, ...

Coupling monitoring with prediction - both micro-weather prediction (for crops/forest/...) and macro-weather prediction with lots of local measurements as input.



# Is saying “Internet of xxx” misleading?

Dirk Trossen, Chief Researcher, BT Research in a recent talk at the Internet of Things 2008 conference says that think of the various xxx’s impairs our thinking and results in embedded concerns into the architecture, thus he proposed “Tussle networking”[30].

This is because communication is delimited by questions such as [30]:

- **Who** to share **what** with?
- **Where** to deliver/produce/consume/...
- **What** to receive in return?
- **How** to receive what I need?
- **What** is it used for?

He goes on to say that the concerns of “individuals, organizations, communities, and societies could lead to conflicts (tussles)” ⇒ explicitly representing concerns as **constraints**. These are resolved at run time via “policy mediation, negotiation, and enforcement”.

# Trossen's Tussle Internet

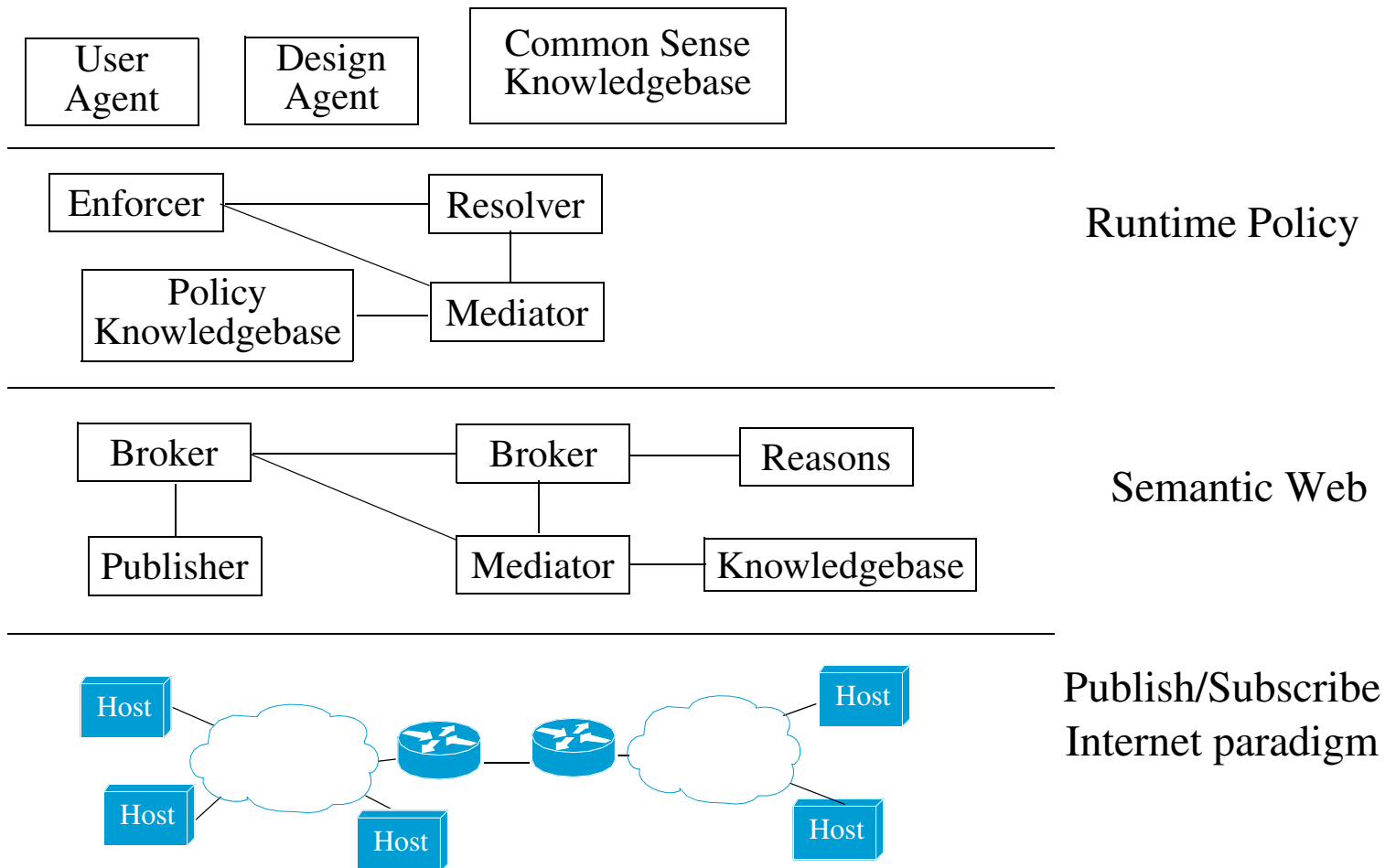
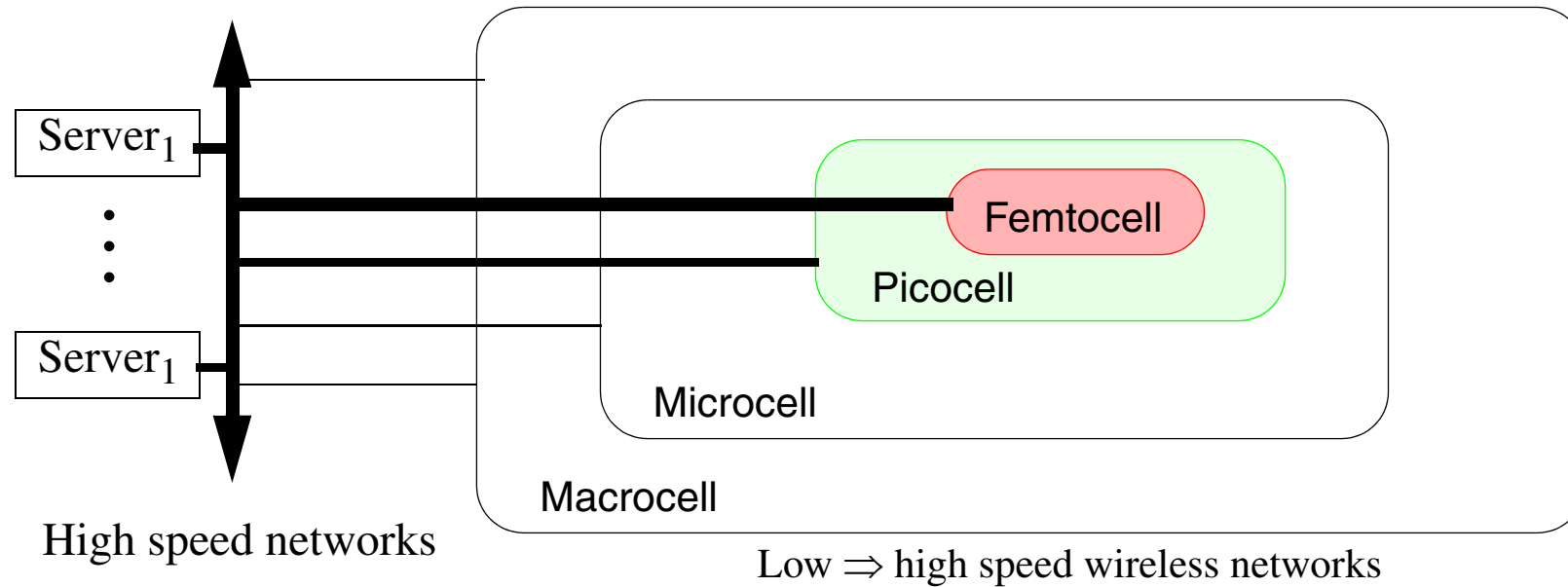

Figure 4: Trossen's Tussle Internet, adapted from slide 10 of [30]

Note that this **publish subscribe** oriented provisioning plane should remind us of the slide See "Dissemination not conversation" on page 5.

# Bottlenecks

- Server and Network Bandwidth and **latency**



- User Bandwidth and **latency**

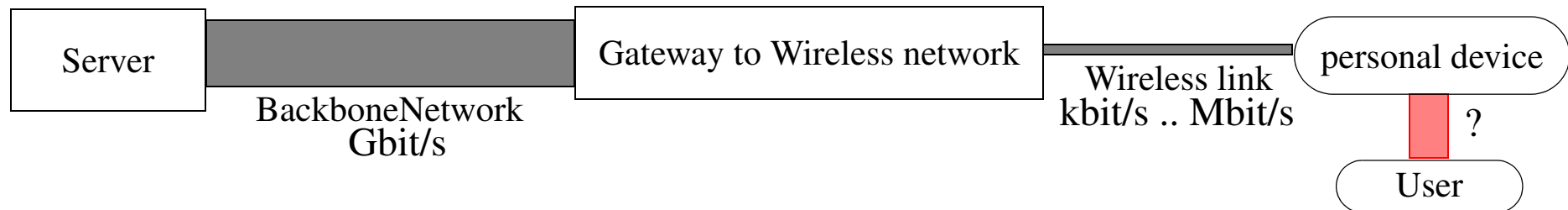

- Power and Energy ⇒ need a computational theory of  $O(\text{energy})$
- **Imagination!**

# Near Future systems

## Personal Portal

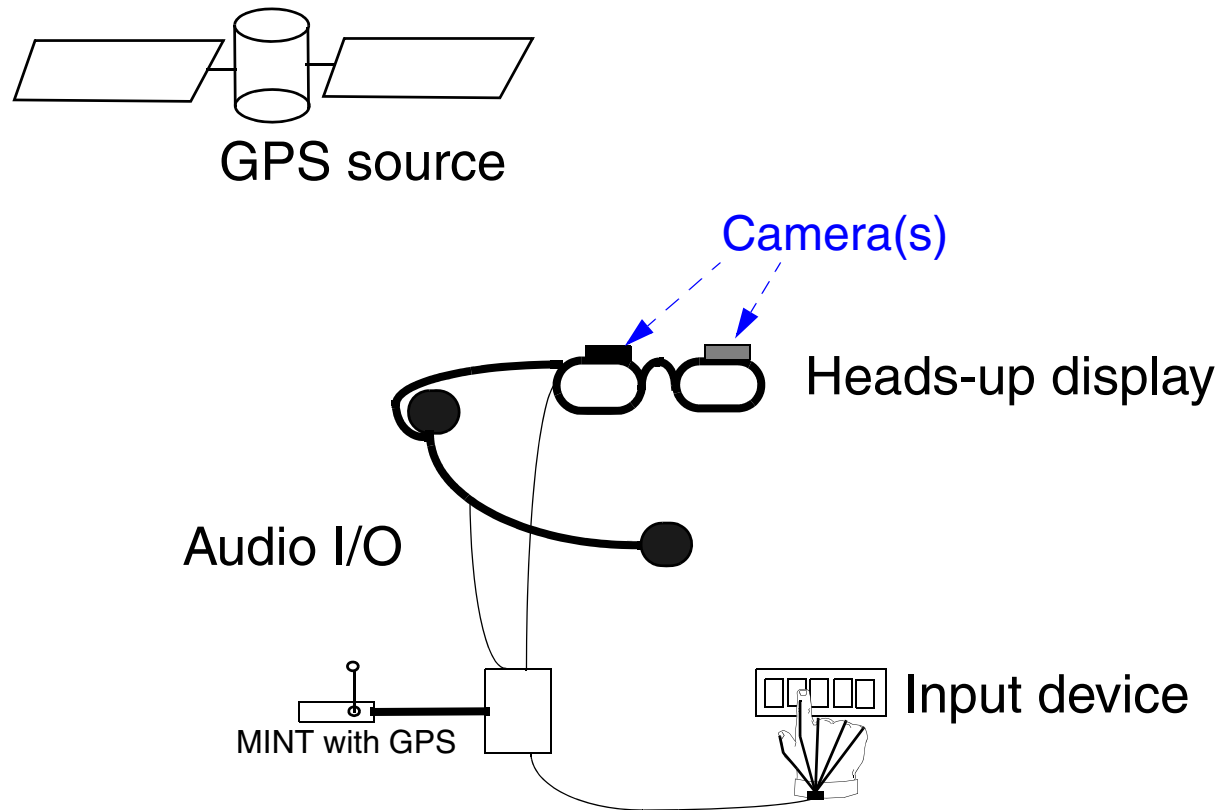

Figure 5: Vision-2, 2000 - high level of integration

# Evolution of new varieties of networks

Already we have: **WANs** (Wide Area), **MANs** (Metropolitan Area), **LANs** (Local Area Networks)

**VANs**      **Vehicle Area Networks**

## Very local networks

**DANs**      **Desk Area Networks**

The computer/printer/telephone/... will all be part of a very local area network on your desk.

- ◆ wireless links ⇒ No longer will you have to plug your printer into your computer (PDA/...) into your computer
- ◆ active badges ⇒ No longer will you have to sign in/out of areas, write down peoples names at meetings, ... the system can provide this data based on the active badges

Olivetti and Xerox are exploring “Teleporting” your windows environment to the workstation nearest you, on command, if there are multiple choices probe each one (currently a “beep” is emitted to tell the user which).

**BANs**      **Body Area Networks**

Users will be carrying multiple devices which wish to communicate:

- ◆ thus there will be a need for a network between these devices which you carry around; and
- ◆ personal devices will wish to interact with fixed devices (such as Bankomat machines, vehicle control systems, diagnostic consoles (for a “mechanic” or repairman), ...) and other peripherals.

# Situational awareness and Adaptability

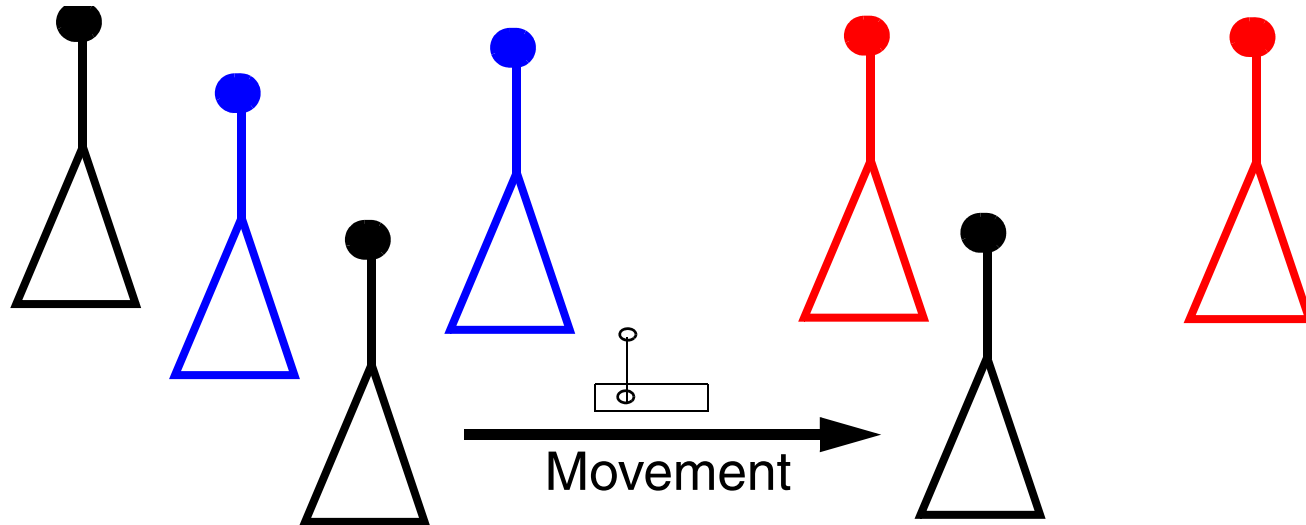

Figure 6: Where am I? What am I? Who am I?

Where am I going? When will I be there? What should I become? Who should I become?

- Location dependent services
- Predicting location to reduce latency, reduce power, hide position, ...
- Adapting the radio to the available mode(s), purposely changing mode, ...
- Reconfigure the electronics to adapt, for upgrades, for fault tolerance, ...; Reconfiguration vs. powering up and down fixed modules (what are the “right” modules, what is the “right” means of interconnect, what is the “right” packaging/connectors/..., needed speed of adaptation)
- “right” level of independence; spectrum from Highly Independent  $\Rightarrow$  Very Dumb

# Location Dependent service(s)

## How do I know where I am?

- Outdoors: GPS or from the network operators knowledge [resolution: 100m to sub-centimeter]
- Indoor: IR and RF beacons, triangulation, knowing what you can **see** or **hear**

## What can I do with this knowledge?

KTH students built a JAVA Applet which gets data from GPS unit and dynamically displays a list of the information available - as a function of where you are:

- ◆ if near bus, subway, train stop - you get transit information - potentially with real-time schedule - since the system knows current location of vehicles
- ◆ list of restaurants, shops, etc. where you are and in the direction you are headed
  - ◆ the scope is based on your **velocity vector** - so if you move quickly it reduces detail, but increases the scope
- ◆ map information with updated position

## How do I know who I'm with or what I'm near?

- Olivetti, Xerox, and MIT - using IR emitters as "ID" tags
  - ◆ Olivetti put them on people, equipment, ...
  - ◆ Xerox put them on electronic notepads, rooms, ...
  - ◆ MIT Media Lab is putting them on people + lots of inanimate objects (clock, fish tank, ...)

# Human centered

- Computer - human interaction is currently focused on the computer (computer-centric)
  - ◆ Currently computers know little about their environment
    - ◆ **Where** are we?
    - ◆ **Who** is using me?
    - ◆ Is the user **still** there?
- Evolving Environment awareness
  - ◆ Give computers senses via sensors
    - ◆ **Environment**
    - ◆ User **identity** and **presence**
- Badge as a smart card replacement
  - ◆ biometric signature of the person currently using the badge
  - ◆ the badge ensures that only you can use it
- You wear your own personal user interface
  - ◆ interface can be consistent across all appliances
    - ◆ not because each appliance supports the interface, but because the user's own interface provides consistency
- Make the **human** the focus of the computer's interaction ( $\Rightarrow$  human-centric)



# Requirements

- Systems with which humans wish to interact:
  - ◆ traditional computers, desktop workspaces, domestic appliances, building and automotive systems, doors, elevators (lifts), environmental control, seats and mirrors, etc.
- Systems to provide sensor data:
  - ◆ location, orientation, light, heat, humidity, temperature, gas analysis, biomedical, ...
- Systems to correlate the sensor information and provide it in a useful way to the computer systems:
  - ◆ Spatial and temporal sensor fusion,
  - ◆ 3D and 4D databases,
  - ◆ Machine Learning, and
  - ◆ Prediction (based on pattern extraction)
- Agents and actuators to provide intelligent control of the environment
- wireless/wired/mobile communications **infrastructures** to link it all together
  - ◆ must assure privacy and security

# Dumb Badge, Smart Badge, and Intelligent Badge

- Dumb Badge just emits its ID periodically
- Smart Badge - [an IP device] Location and Context Aware (i.e., a sensor platform)
- Intelligent Badge - add local processing for local interaction by the user

Acknowledgment:

All of the badge work is done in cooperation with:

- Dr. Mark T. Smith - Hewlett-Packard Research Laboratories, Palo Alto, California, USA
- Dr. H. W. Peter Beadle
  - ◆ Formerly: University of Wollongong, Wollongong, Australia
  - ◆ Currently: Director, Motorola Australian Research Centre, Botany, NSW, Australia

# Badge Communications Model

Badges are IP devices (or should be), they communicate via network attached access points.

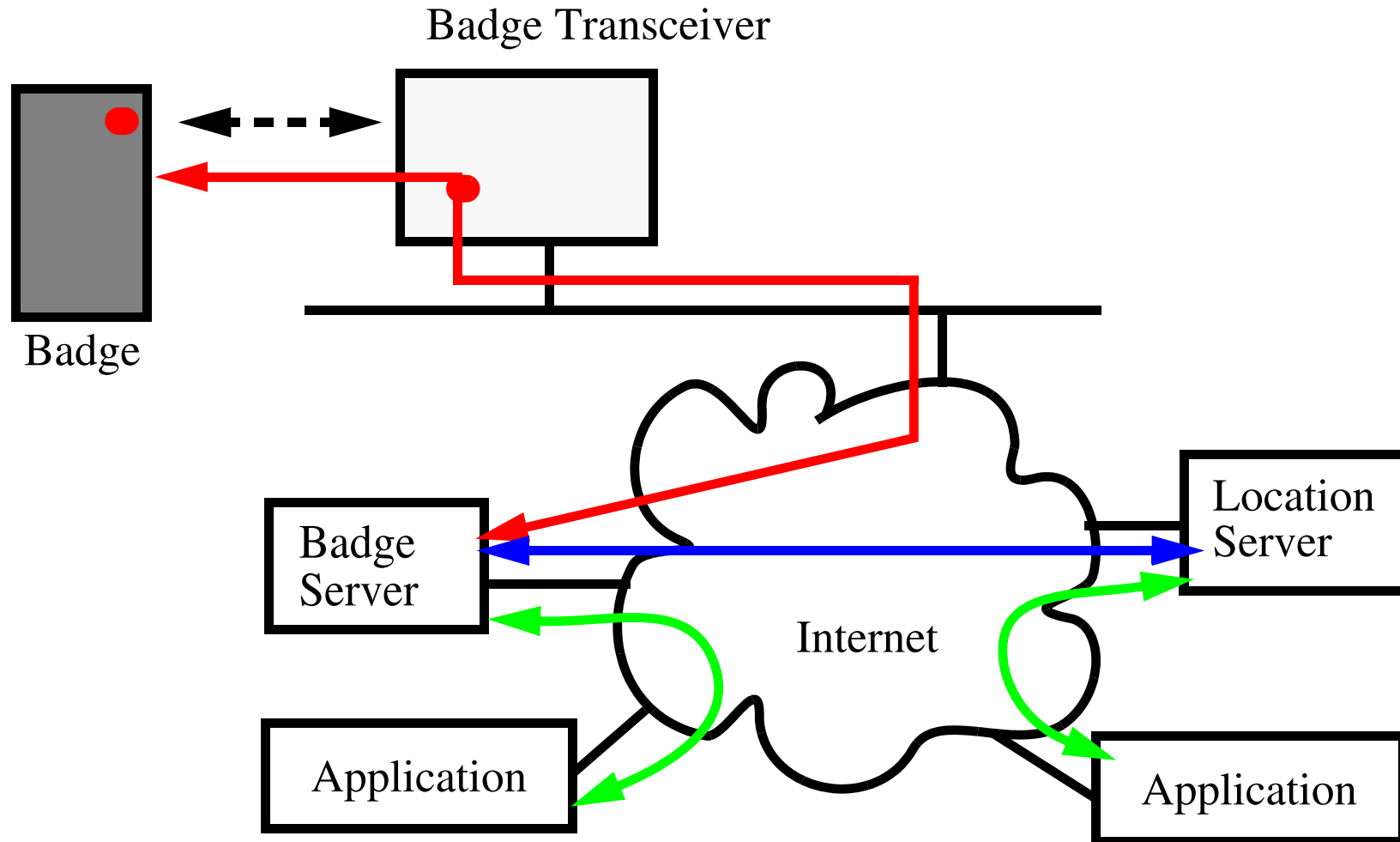

⇒ Banks as intermediaries (**if** they have **any** future role)

# Smart Badge 3

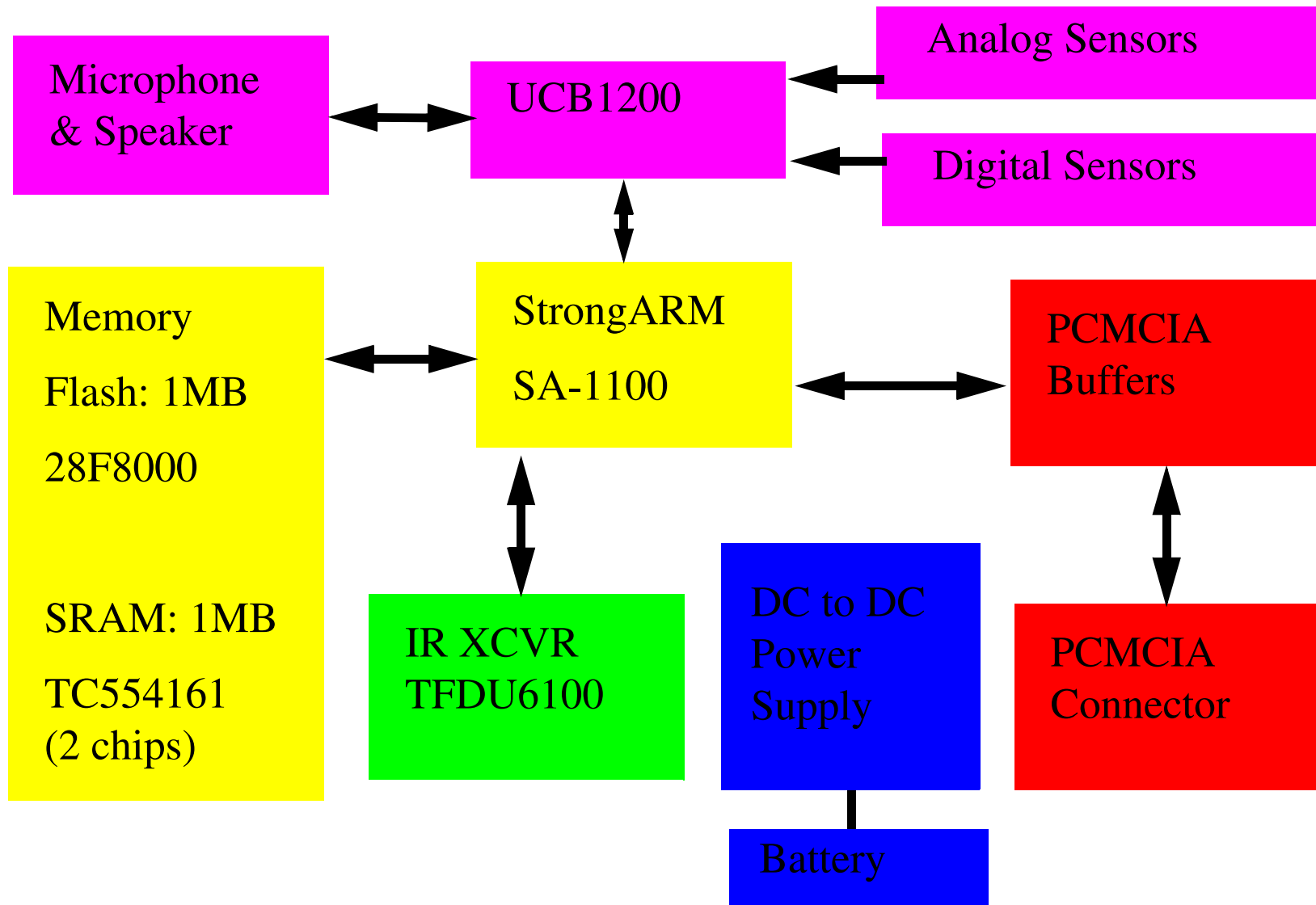

# Smart Badge Sensors

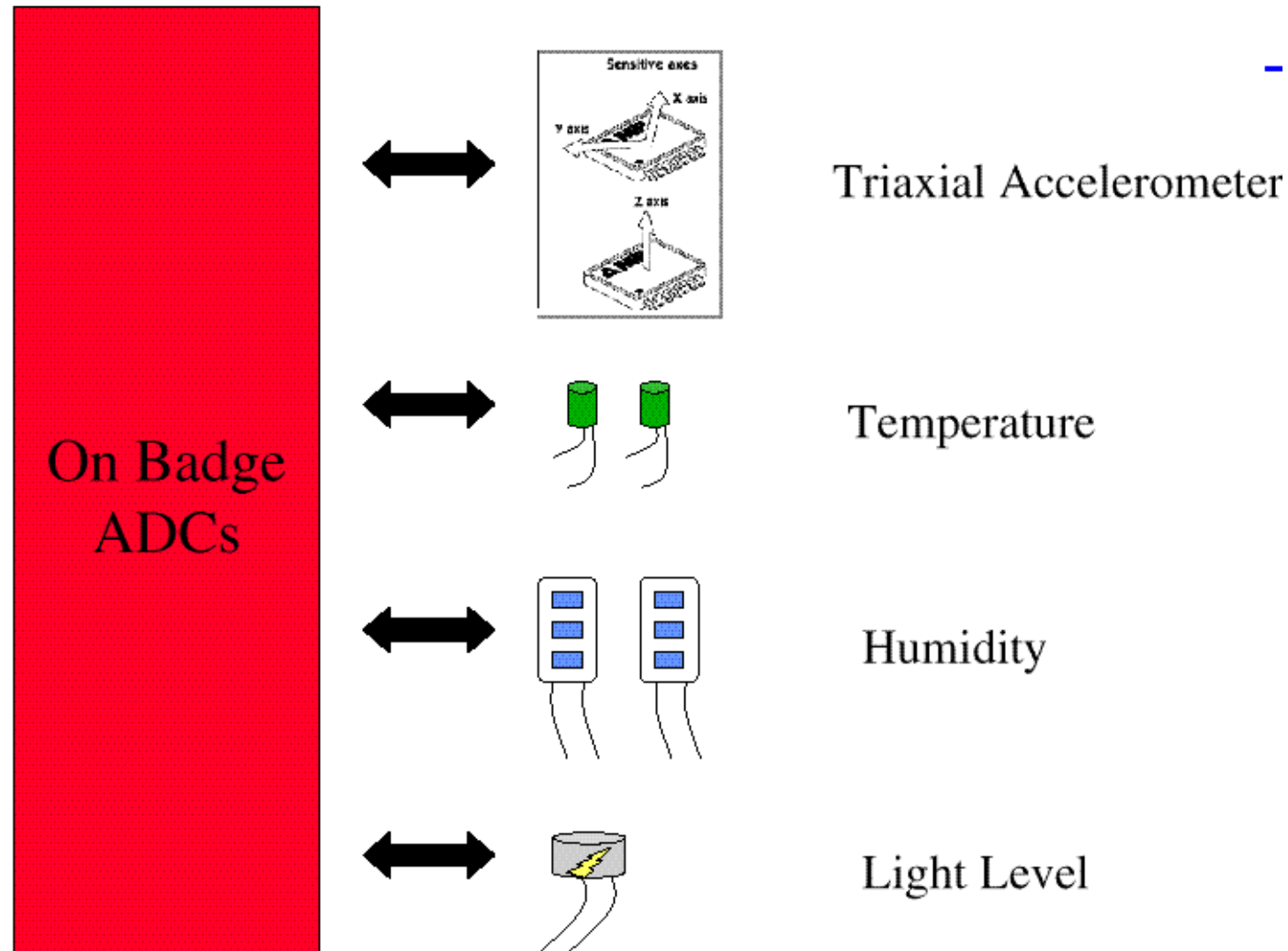

Details of the 3rd version:

<http://www.it.kth.se/edu/gru/Fingerinfo/telesys.finger/Mobile.VT98/badge3.html>

# Badge 3

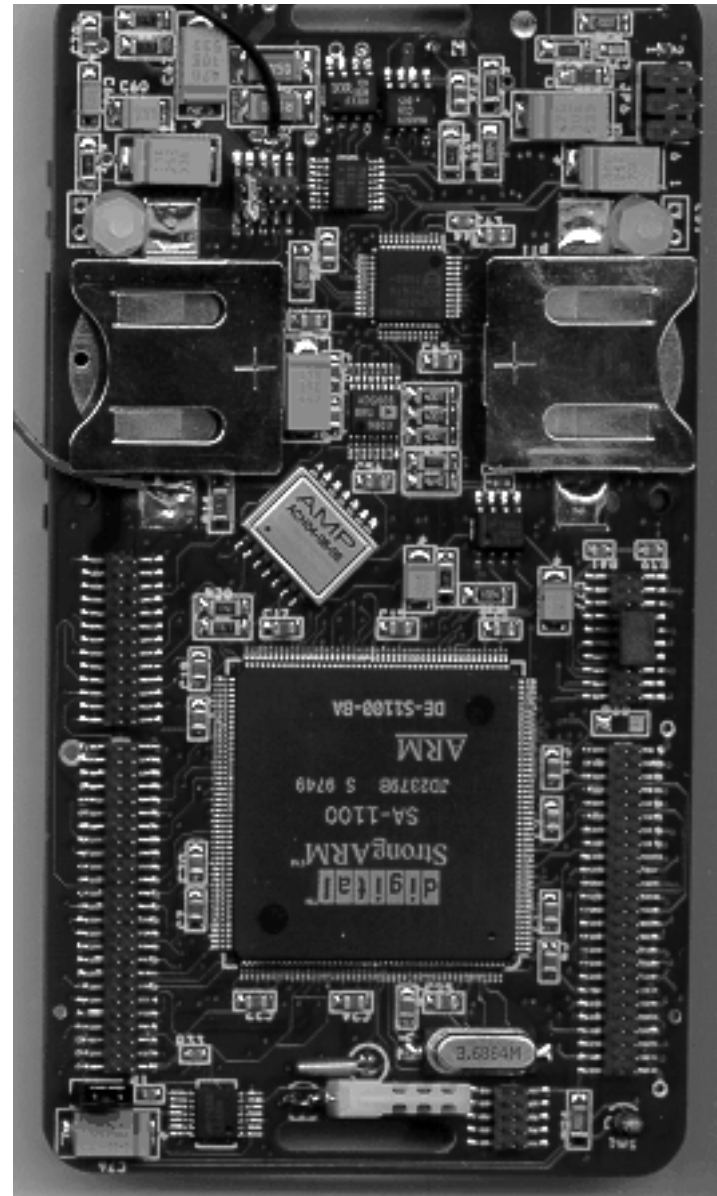
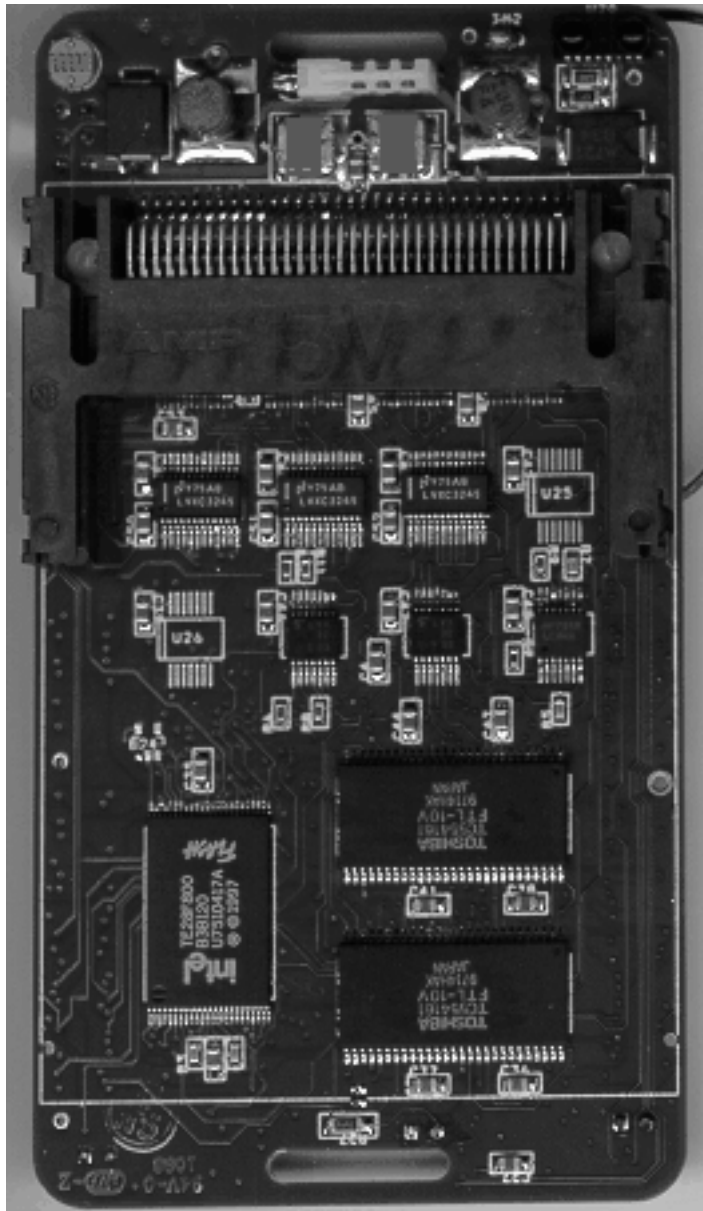

# A view of the packaged badge

As shown by HP at Comdex'98, November 16-20, 1998



# MEDIA

High integration (goal of MEDIA project)

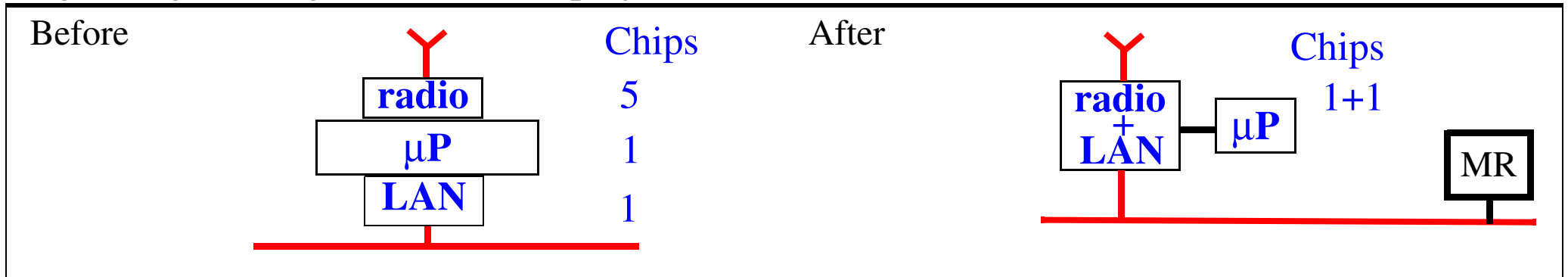

## Partners:

- Kungl Tekniska Högskolan (KTH/ELE/ESDlab and KTH/IT/CCSlab)
- Tampere University of Technology (TUT)
- GMD FOKUS (GMD)
- Technische Universität Braunschweig (UBR)
- Interuniversity Microelectronics Centre (IMEC)
- Ericsson Radio Systems AB (ERA)

See <http://www.ele.kth.se/ESD/MEDIA> for more information



# Split the functions between access point and access point server

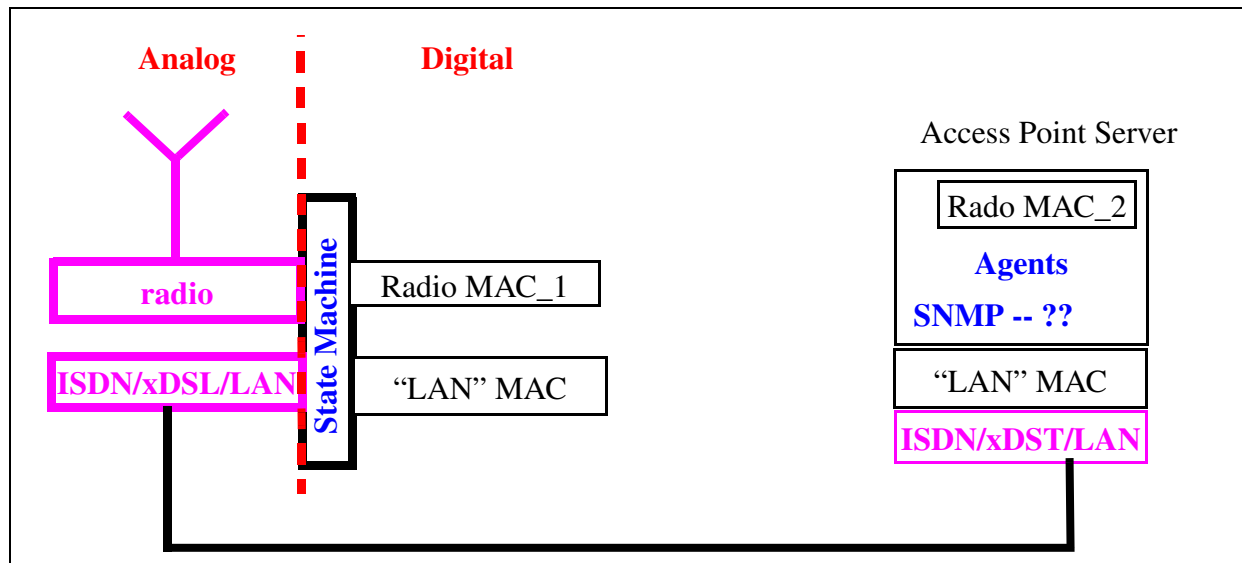
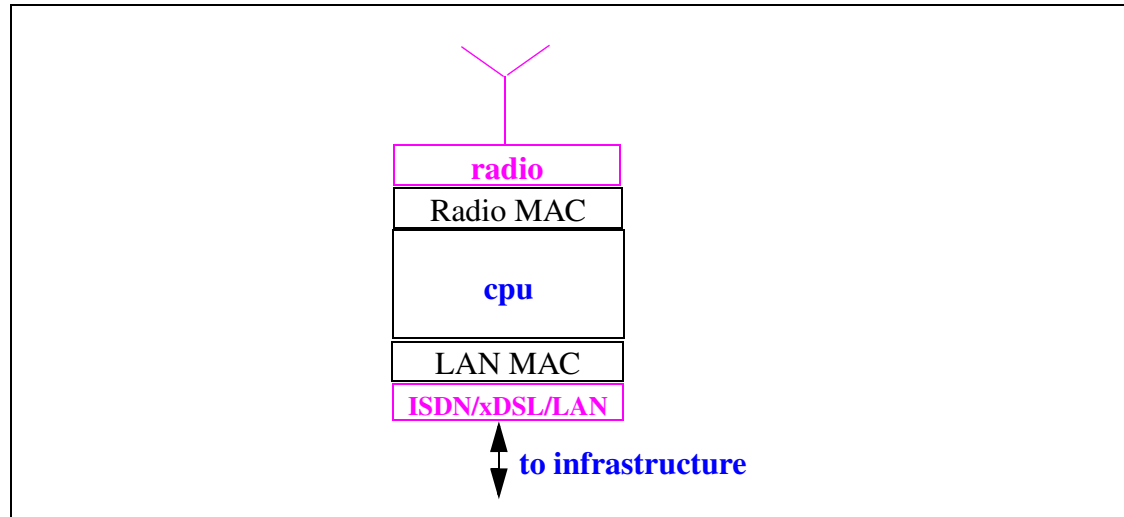

# Future home/office/... network accesspoints

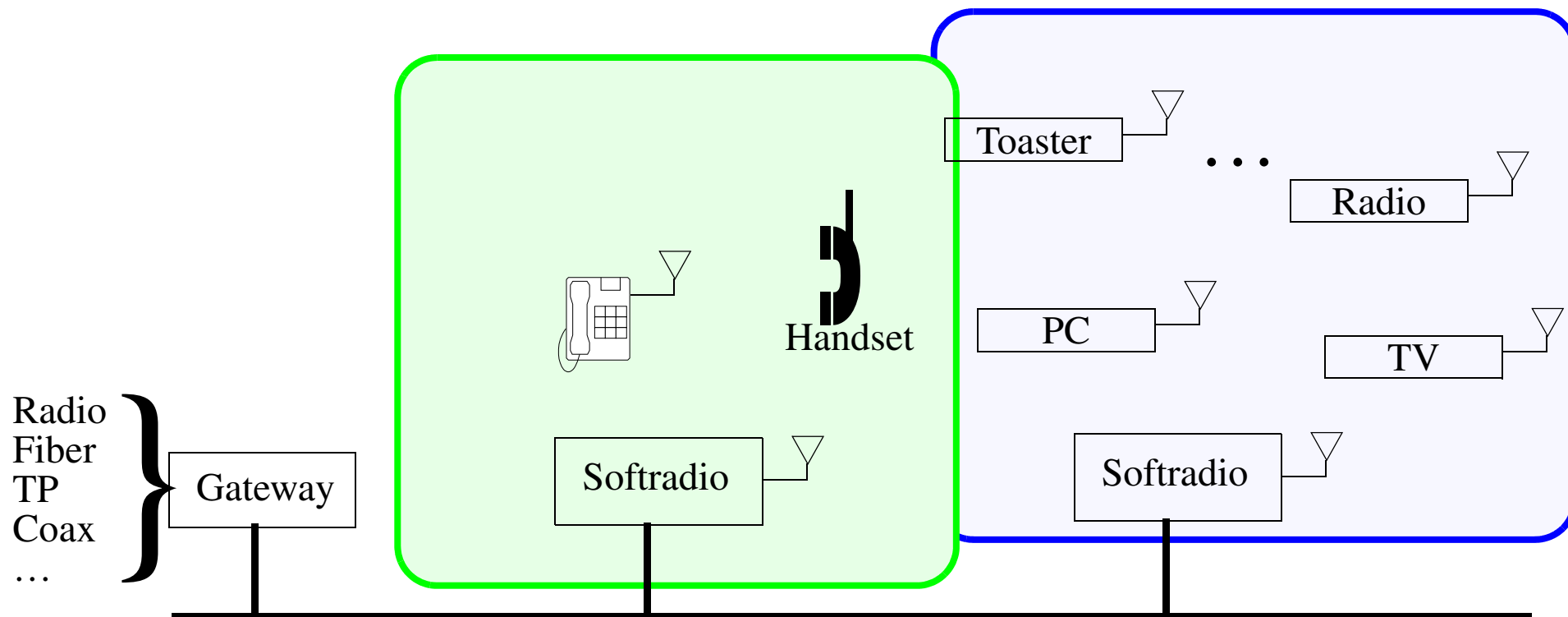

# Personal Computing and Communication (PCC)

Upper limit of bandwidth: saturate the senses: sight, sound, touch, smell, taste  
⇒ ~1 Gbit/sec/user

Current workstations shipping with 1 Gbit/sec interfaces for LAN!

Telepresence for work is the long-term “killer” application

-- Gordon Bell and James N. Gray<sup>1</sup>

---

1. “The Revolution Yet to Happen” in Beyond Calculation: The Next Fifty Years of Computing, Eds. Denning and Metcalfe, Copernicus, 1997.

# Uploading ourselves to the net

In Bob Metcalfe's speech at MIT: <http://web.mit.edu/alum/president/speech.html>

One of great insights of this talk is that the internet is the way to **immortality**<sup>1</sup>:

Now, for the next 50 years, the web will drive electronic commerce into the information age, ubiquitous computers will disappear into the woodwork, and we'll start uploading ourselves into the Internet to become at last immortal.

-- Robert M. Metcalfe  
June 26, 1997

---

1. Robert M. Metcalfe, "Internet Futures", MIT Enterprise Forum, June 26, 1997.

# Future Systems

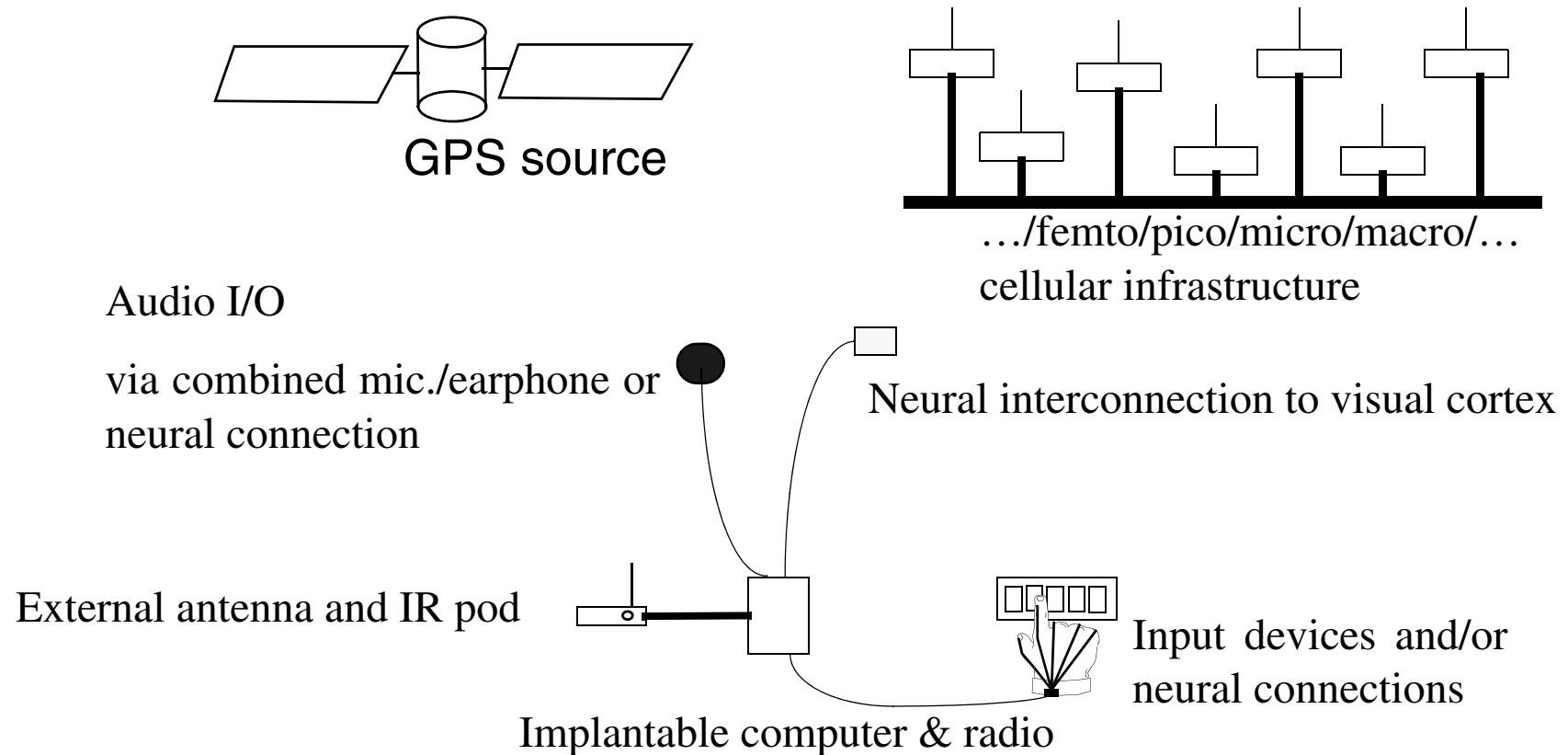

Figure 7: Vision-3, 2005-2015 - very high level of integration

# Bionic Technologies, Inc.'s Intracortical Electrode Array

Acute microelectrode assembly (10x10 array, 100 active electrodes) . . . . . \$1,250.00

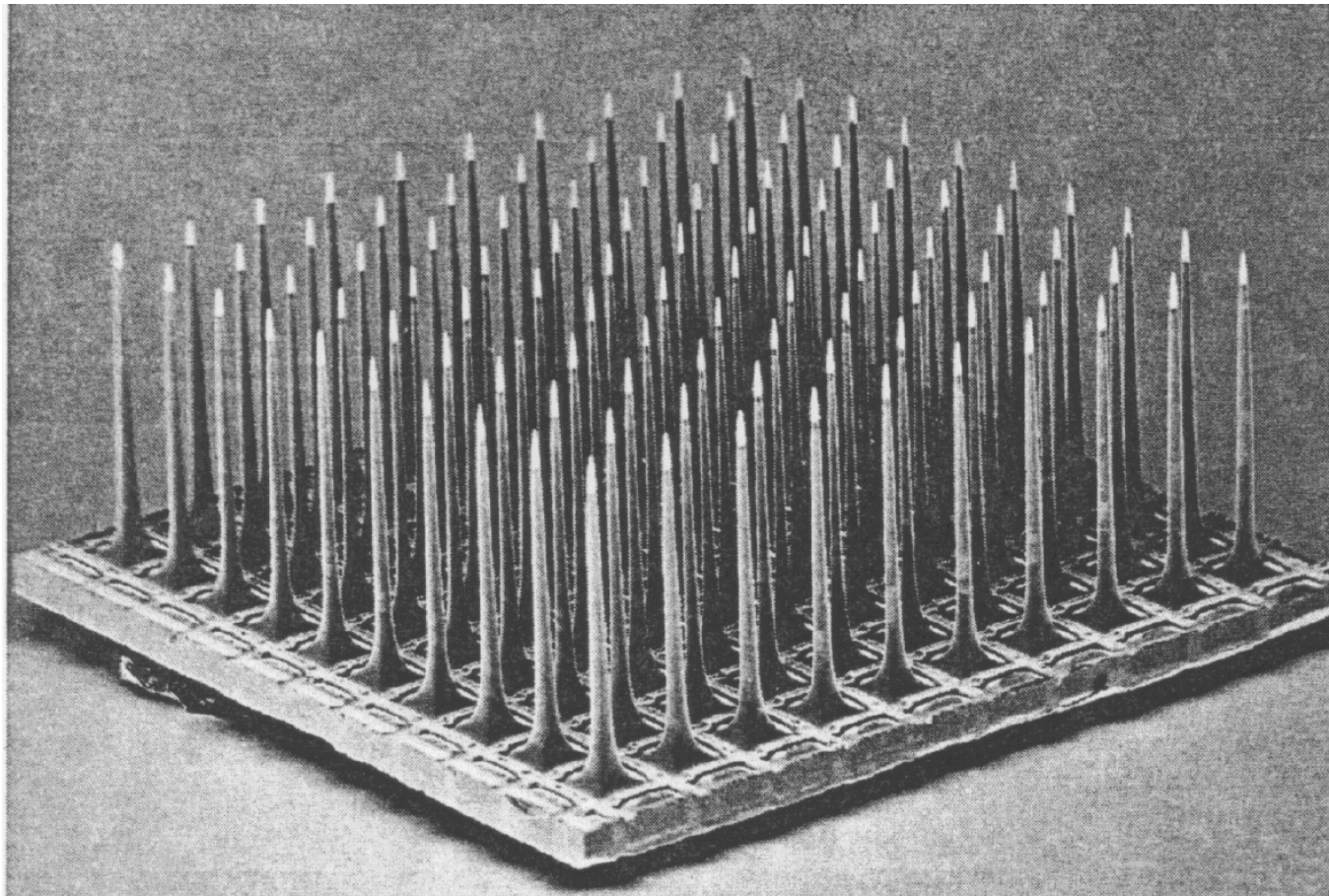

Figure 8: 10 x 10 silicon electrode array (each electrode: 1.5mm long, 0.08mm wide at base, 0.001mm tip), Built at the Univ. of Utah, by Richard A. Normann, et al.; from Scientific American, March 1994, pg. 108.

# Non-metallic bi-directional neural interfaces

Neurochip: Neuron silicon circuits <http://mnphys.biochem.mpg.de/> :

(a) Silicon-Neuron Junction (input to the nerve)

(b) Neuron transistor (output from the nerve)

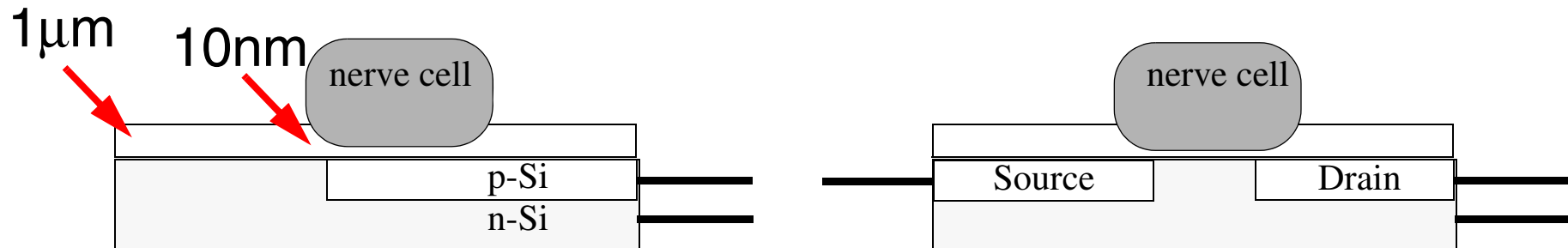

Figure 9: (a) Capacitive coupling of data into nerve and  
(b) using the charge in the nerve to control a transistor's gate for getting data out of the nerve

(a) Peter Fromherz and Alfred Stett, “Silicon-Neuron Junction: Capacitive Stimulation of an Individual Neuron on a Silicon Chip” *Phys.Rev.Lett.* 75 (1995) 1670-1673

(b) P.Fromherz, A.Offenhäusser, T.Vetter, J.Weis, “A Neuron-Silicon Junction: A Retzius-Cell of the Leech on an Insulated-Gate Field-Effect Transistor” *Science* 252 (1991) 1290-1293.

# What is **your** time line?

- What is going to be your planning horizon?
- What will be the depreciation time for your equipment/software/infrastructure/... ?
- How fast:
  - ◆ can you change?
  - ◆ should you change?
  - ◆ will you change?



# Spotting trends at 1%

Mark J. Penn with E. Kinney Zalesne book:

*Microtrends: The small forces behind tomorrow's big changes* [40]

⇒ trend spotting

The goal is to spot trends early enough to exploit them, while your competitors do not even realize there is an opportunity!

⇒ Innovation

# Summary

- Telecom operators are **reinventing themselves and their infrastructures**
- Things to watch IPv6, IPsec, Mobile-IP, DHCP, the new domain name registries, appliances, ...
- Low cost access points which exploit existing or easily installed infrastructure are key to **creating a ubiquitous mobile infrastructure with effectively infinite bandwidth.**
- Smart Badge is a vehicle for exploring our ideas:
  - Exploits hardware and software complexity by hiding it.
  - Explores allowing devices and services to use each other in an extemporaneous way.
  - Enables a large number of location and environment aware applications, most of which are service consuming.
  - Keep you eyes open for the increasing numbers of sensors which will be on the network.
  - Service is where the money is!
- Personal Communication and Computation in the early 21st century: **“Just Wear IT!”**
- Coming in 20-30 years: “Just implant IT!”
- Remember: The internet will be what **you** make it.

# Further Reading

- [1] Kalevi Kilkki, *Differentiated Services for the Internet*, Macmillan Technical Publishing, 384 pages, June 1999, ISBN: 1578701325.
- [2] PCI-SIG, *PCI-X 2.0: High Performance, Backward Compatible PCI for the Future*, May 19, 2005  
[http://www.pcisig.com/specifications/pcix\\_20](http://www.pcisig.com/specifications/pcix_20)
- [3] USB.org, *Universal Serial Bus Revision 2.0 specification*, May 19, 2005  
[http://www.usb.org/developers/docs/usb\\_20\\_02212005.zip](http://www.usb.org/developers/docs/usb_20_02212005.zip)
- [4] Tom Clark, *IP SANS: A Guide to iSCSI, iFCP, and TCIP Protocols for Storage Area Networks*, Addison-Wesley, 288 pages, 2002, ISBN: 0-201-75277-8
- [5] Patrik Fältström, “Future of the Internet”, Lecture slides, 27 March 2008, <http://stupid.domain.name/stuff/future-internet.pdf>
- [6] Jonathan Zittrain, *The Future of the Internet -- And How to Stop it*, New Haven: Yale University Press, 342 pages, 2008. ISBN 978-0-300-12487-3, Web site of the book and blog: <http://futureoftheinternet.org/> ; the author’s web site: <http://www.jz.org/>
- [7] Bob Briscoe, Andrew Odlyzko, and Benjamin Tilly, *Metcalf’s Law is Wrong*, IEEE Spectrum, July 2006  
<http://www.spectrum.ieee.org/jul06/4109>
- [8] Richard D. Lewis, *When Cultures Collide: Managing Successfully Across Cultures*, Nicholas Brealey Publishing, 2000, 462 pages, ISBN 1857880870, 9781857880878
- [9] Richard D. Lewis, *When Cultures Collide: Leading Across Cultures*, Nicholas Brealey Publishing, 2005, ISBN 1904838022, 9781904838029
- [10] Ray Kurzweil, *The Singularity Is Near: When Humans Transcend Biology*, Viking, 2005
- [11] Ulf Jönsson, Fredrik Alriksson, Tony Larsson, Per Johansson, and Gerald Q. Maguire Jr, *MIPMANET - Mobile IP for Mobile Ad Hoc Networks*, First Annual Workshop on Mobile Ad Hoc Networking & Computing, IEEE/ACM, August 11, 2000, Boston, Massachusetts. <http://doi.acm.org/10.1145/514151.514163>
- [12] Lawrence Lessig, *The Future of Ideas: The Fate of the Commons in a Connected World*, New York: Random House, 352 pages, 2001.

<http://www.law.stanford.edu/publications/details/1755/The%20Future%20of%20Ideas:%20The%20Fate%20of%20the%20Commons%20in%20a%20Connected%20World/>

- [13] The Future of the Internet: A Compendium of European Projects on ICT Research Supported by the EU 7th Framework Programme for RTD, Brochure by the European Commission, Information Society and Media DG, May 2008, ISBN 978-92-79-08008-1  
[ftp://ftp.cordis.europa.eu/pub/fp7/ict/docs/ch1-g848-280-future-internet\\_en.pdf](ftp://ftp.cordis.europa.eu/pub/fp7/ict/docs/ch1-g848-280-future-internet_en.pdf)
- [14] Ronald Deibert, John Palfrey, Rafal Rohozinski, and Jonathan Zittrain, eds., Access Denied: The Practice and Policy of Global Internet Filtering, (Cambridge: MIT Press) 2008. <http://opennet.net/accessdenied>
- [15] Amin Vahdat and David Becker, “Epidemic Routing for Partially-Connected Ad Hoc Networks”, Technical Report CS-2000-06, Duke University, July 2000. <http://issg.cs.duke.edu/epidemic/epidemic.pdf>
- [16] Jon Crowcroft, Eiko Yoneki, Pan Hui, and Tristan Henderson, Promoting Tolerance for Delay Tolerant Network Research, Editorial Note, Computer Communication Review, Volume 38, number 5, October 2008, pp. 63-68.  
<http://ccr.sigcomm.org/online/files/p63-crowcroft.pdf>
- [17] Rui L. Aguiar, “Somme Commented on Hourglasses”, Editorial Note, Computer Communication Review, Volume 38, number 5, October 2008, pp. 69-72. <http://ccr.sigcomm.org/online/files/p69-aguiar.pdf>
- [18] Cao Wei Qiu, A new Content Distribution Network architecture - PlentyCast, Masters thesis, KTH, IMIT, IMIT/LCN 2004-05, April 2004 [http://web.it.kth.se/~maguire/DEGREE-PROJECT-REPORTS/040430-Cao\\_Wei\\_Qiu-with-cover.pdf](http://web.it.kth.se/~maguire/DEGREE-PROJECT-REPORTS/040430-Cao_Wei_Qiu-with-cover.pdf)
- [19] Ayodele Damola, Peer to peer networking in Ethernet broadband access networks, Masters thesis, KTH, IMIT, IMIT/LCN 2005-10, May 2005 [http://web.it.kth.se/~maguire/DEGREE-PROJECT-REPORTS/050529-Ayodele\\_Damola-with-cover.pdf](http://web.it.kth.se/~maguire/DEGREE-PROJECT-REPORTS/050529-Ayodele_Damola-with-cover.pdf)
- [20] Athanasios Makris and Andreas Strikos, Daedalus: A media agnostic peer-to-peer architecture for IPTV distribution, Masters thesis, Royal Institute of Technology (KTH), School of Information and Communication Technology, Stockholm, Sweden, COS/CCS 2008-11, June 2008 [http://web.it.kth.se/~maguire/DEGREE-PROJECT-REPORTS/080624-Makris\\_and\\_Strikos-with-cover.pdf](http://web.it.kth.se/~maguire/DEGREE-PROJECT-REPORTS/080624-Makris_and_Strikos-with-cover.pdf)
- [21] Don Tapscott and Anthony D. Williams, Wikinomics: How mass Collaboration Changes Everything, Portfolio, 2008, ISBN-13: 978-1591841937 <http://www.wikinomics.com/book/>
- [22] Damon Wischik, Mark Handley, and Marcelo Bagnulo Braun, “The Resource Pooling Principle”, ACM/SIGCOMM Computer Communication Review, Volume 38, Number 5, October 2008, pp. 47-52  
<http://ccr.sigcomm.org/online/files/p47-handleyA4.pdf>

- [23] Darwin Valderas Núñez, “Integration of sensor nodes with IMS”, Masters Thesis, School of Information and Communication Technology, Royal Institute of Technology (KTH), COS/CCS 2008-22, October 2008  
<http://web.it.kth.se/~maguire/DEGREE-PROJECT-REPORTS/081008-DarwinValderas-with-cover.pdf>
- [24] Mikael Gunnarsson, Truck-Trailer Wireless Connections, Masters Thesis, School of Microelectronics and Information Technology, Royal Institute of Technology (KTH), December 2001
- [25] Elmar Schoch, Frank Kargl, Michael Weber, and Tim Leinmüller, “Communication Patterns in VANETs”, IEEE Communications Magazine, Volume 46, number 11, November 2008, pp. 119-125.
- [26] Panagiotis Papadimitratos, Levente Buttyan, Tamás Holczer, Elmar Schoch, Julien Freudiger, Maxim Raya, Zhendong Ma, Frank Kargl, Antonio Kung, and Jean-Pierre Hubaux, Secure Vehicular Communication Systems: Design and Architecture, IEEE Communications Magazine, Volume 46, number 11, November 2008, pp. 100-109.  
<http://infoscience.epfl.ch/getfile.py?docid=21529&name=sevecom1&format=pdf&version=1>
- [27] WiFi Wireless Secures New Patents for Cargo Tracking and Monitor Systems, News Report, Government Technology Magazine, Folsom, CA, USA, April 11, 2007, <http://www.govtech.com/gt/articles/104903>
- [28] I. Koljushev, P. Toivola, and A. Vesterinen, Combining the Construction Period and Service Life Structural Monitoring Requirements to Enable Delivery of a Single, Cost Effective Solution, Fifth International Conference on Bridge Management, 11-13 April 2005. <http://www.futurtec.fi/downloads/BM5%2520April%25202005%2520reprint.pdf>
- [29] Bernard Basile, “Monitoring the Structural Health of the Rion-Antirion Bridge Using LabVIEW Real-Time”, National Instruments Corporation, 4 August 2007. <http://sine.ni.com/cs/app/doc/p/id/cs-68>
- [30] Dirk Trossen, “From The Internet of ??? To The Future Internet”, Internet of Things 2008 conference, Zurich  
<http://www.the-internet-of-things.org/prg/slides/trossen.pdf>
- [31] Ludwig Siegele, Let it Rise: A special report on corporate IT, The Economist, October 25th 2008  
[http://www.economist.com/specialreports/displayStory.cfm?story\\_id=12411882](http://www.economist.com/specialreports/displayStory.cfm?story_id=12411882)
- [32] W. Chan Kim and Renée Mauborgne, Blue Ocean Strategy, Harvard Business School Press, 2005, ISBN 10: 1-59139-619-0.
- [33] Clayton M. Christensen, Scott D. Anthony, and Erik A. Roth, Seeing What’s Next: Using the theories of innovation to predict industry change, Harvard Business School Press, 2004, ISBN 10; 1-59139-195-7.
- [34] Chris Anderson, The Long Tail: Why the Future of Business Is Selling Less of More, Hyperion, New York, 2006. ISBN 1-4013-0237-8 or Revised and

Updated edition, July 8, 2008: ISBN-10: 1401309666, <http://www.thelongtail.com/>

- [35] Chris Anderson, *Free: The Future of a Radical Price*, Hyperion, July 7, 2009, 288 pages, ISBN-10: 1401322905, ISBN-13: 978-1401322908 or paperback ISBN 978-1-9052-1148-7
- [36] Andrew Lih, *The Wikipedia Revolution: How a Bunch of Nobodies Created the World's Greatest Encyclopedia*, Hyperion 2009, 272 pages, ISBN-10: 1401303714 and ISBN-13: 978-1401303716 [http://wikipediarevolution.com/The\\_Book.html](http://wikipediarevolution.com/The_Book.html)
- [37] Jeff Jarvis, *What Would Google Do?*, Collins Business, 2009, ISBN 978-0-06-170971-5.
- [38] Ken Auletta, *Googled: The End of the World as We Know It*, Penguin Press HC, (November 3, 2009), 400 pages, ISBN-10: 1594202354, ISBN-13: 978-1594202353 - also in paperback from Virgin Books
- [39] Richard Waters, Three brilliant idealists awaiting wisdom, Book review of *Googled: The End of the World as We Know It*, by Ken Auletta, Financial Times, November 11 2009 20:17, <http://www.ft.com/cms/s/0/35a36ada-cef6-11de-8a4b-00144feabdc0.html>
- [40] Mark J. Penn with E. Kinney Zalesne, *Microtrends: The small forces behind tomorrow's big changes*, Twelve (The Hachette Book Group), NY, NY, 2007, ISBN 978-0-446-69976-1

**General:** <http://www.ietf.org/>

# Thanks

Best wishes on your written assignments (or projects).

# IK1550 Internetworking/Internetteknik

## Spring 2010, Period 4

### Module 14: Some exercises

Lecture notes of G. Q. Maguire Jr.



KTH Information and  
Communication Technology

© 2010 G.Q.Maguire Jr. .

All rights reserved. No part of this course may be reproduced, stored in a retrieval system, or transmitted, in any form or by any means, electronic, mechanical, photocopying, recording, or otherwise, without written permission of the author.

Last modified: 2010.03.21:15:34



# Internets - configuration 1

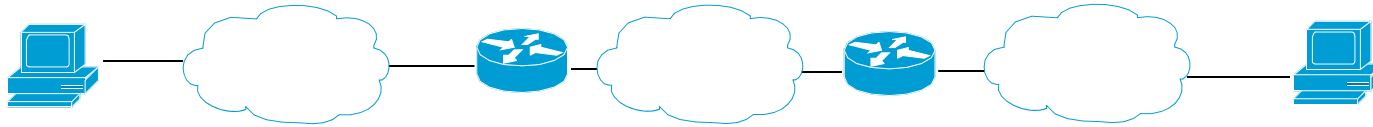

Figure 1: Simple configuration 1

What protocols are likely to be used and where?

# Internets - configuration 2

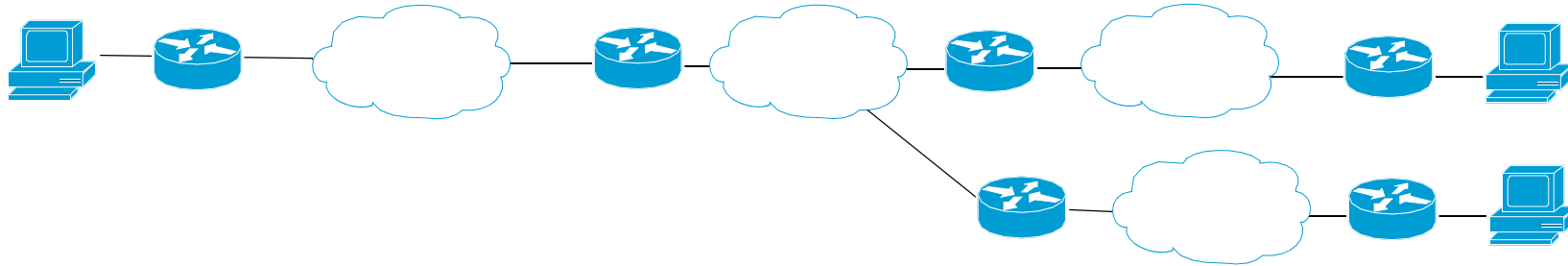

Figure 2: Simple configuration 2

# Internets - configuration 3

Adding a firewall and router

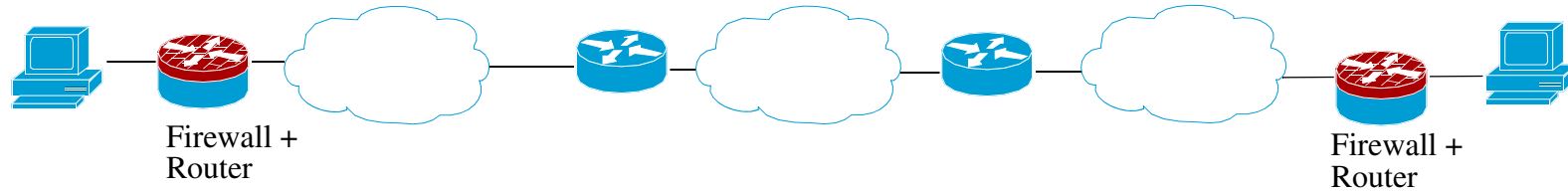

Figure 3: Simple configuration 3

# Internets - configuration 4

Adding a satellite link

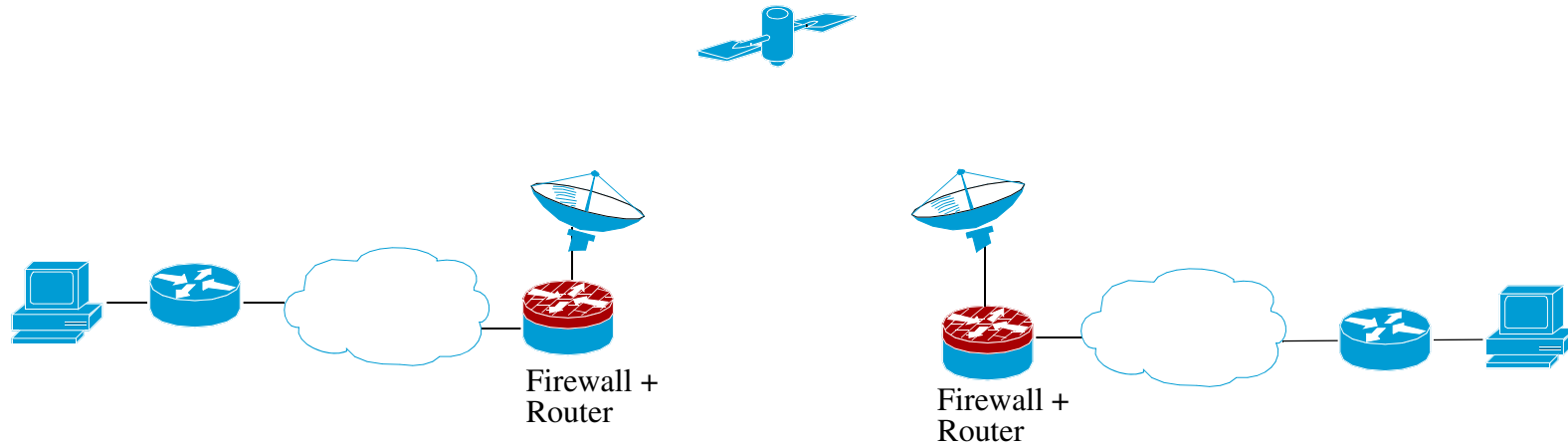

Figure 4: Simple configuration 4

# Internets - configuration 5

Adding a WiMAX link

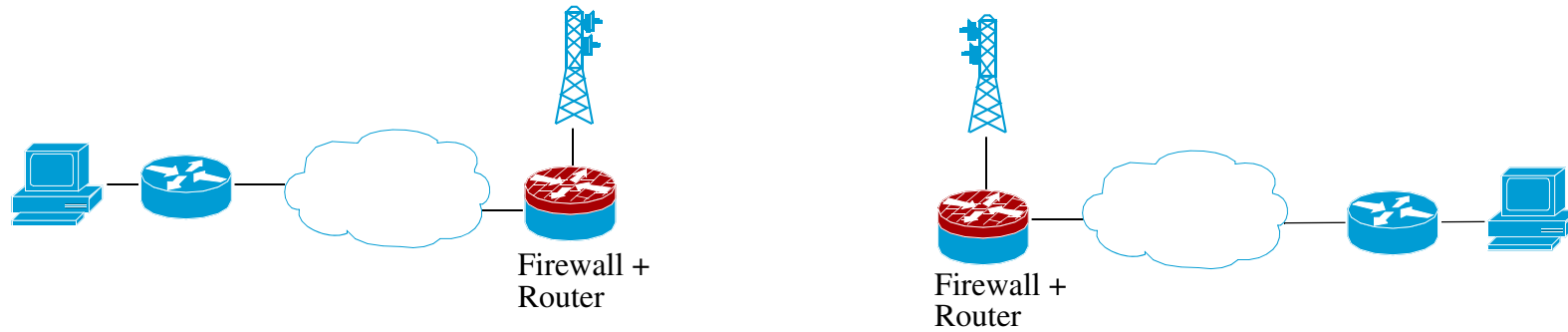

Figure 5: Simple configuration 5

# Configuration 6

## Adding multimedia

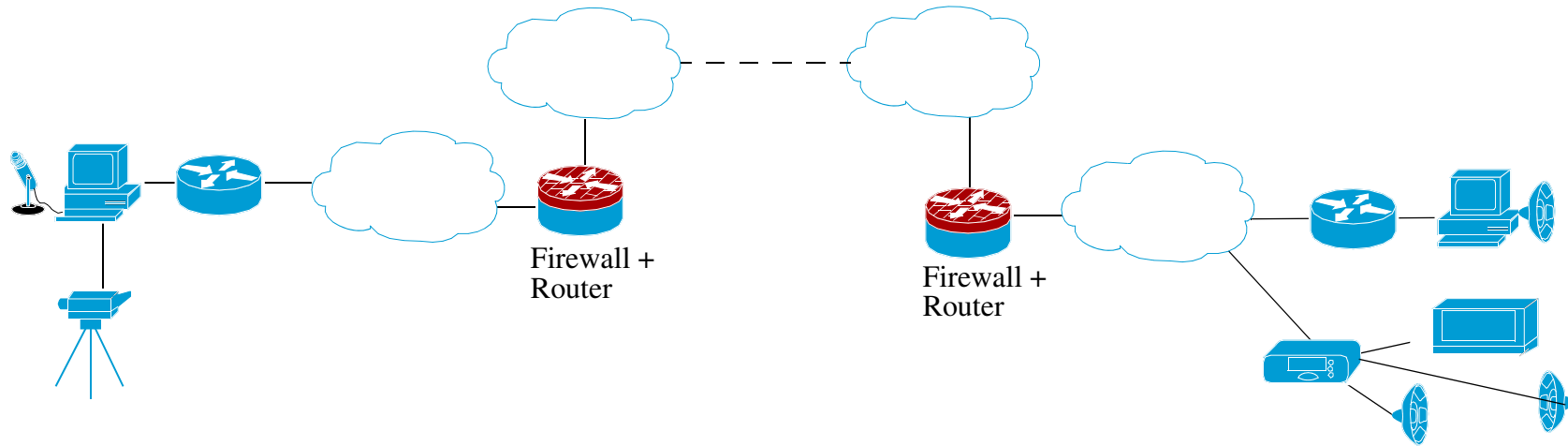

Figure 6: Simple configuration 6

# Configuration 7

Adding two-way multimedia

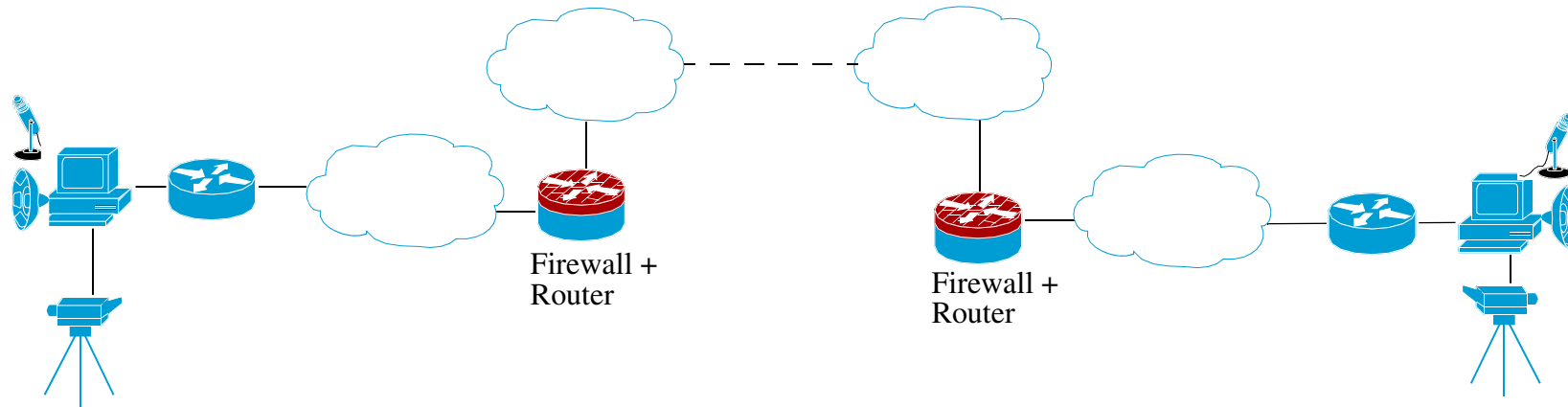

Figure 7: Simple configuration 7