



High power fiber coupling for solid state laser pumping

Andreas Eriksson

Master's thesis

Division of Laser Physics
Department of Applied Physics
KTH – Royal Institute of Technology
Stockholm, Sweden 2009

Abstract

The objective with this thesis work was to focus a pumped solid state laser into optical fibers of different diameters. This was done in three steps. The first a theoretical part where different versions of system set up was simulated in Zemax until the a optimal solution to the problem evolved. The second part was the actual focusing using the solution from from the simulations and then finally a part. In which the normal optical fiber used in part two was replaced by a doped fiber and the solid state laser was used to pump the fiber so the fiber itself started to lase.

Förord

Målet med detta examensarbete var att fokusera en diodlaser in i optiska fiber av olika diameter. Detta gjordes i tre steg. Steg ett var den teoretiska delen där möjliga lösningar simulerades i Zemax. I steg två användes kunskapen från del ett till fokusera dioden in i fiber och slutligen i steg tre byttes den optiska fibern ut mot en optisk fiber som var dopad. Den dopade optiska fibern pumpades med lasern tills den lasrade.

Acknowledgements

I would like to thank my advisor Pär Jelger for day to day help with this thesis work and my advisor Carsten Lindström for helping me understand diode lasers and I would also like to thank my advisor Jens Tellefsen for helping me in the daily work at the department and all the help during the writing of this report. Furthermore I would like to thank my examiner Fredrik Laurell for giving me the chance to do my thesis work at the department for Laser physics at KTH. Finally I would like to thank Björn Jacobsson and Jonas Hellström for both practical and theoretical help in the lab and the rest of the Laser physics group for providing both theoretical and practical help and making this group an enjoyable place to work.

Chapter 1

Introduction

The objective for this thesis work is to focus a highly astigmatic 100 W laser diode working at 980 nm into a fiber, the reason for doing this is so that the power of the diode can easily be used for things such as pumping crystals and doped fibers.

The thesis work started with me learning how to handle Zemax and then I simulated a couple of different systems for focusing the diode. My reasons for using Zemax during this thesis work is its ability to use macros to simulate diode arrays, its built in lens library and also that it is a useful program for me to know. It continued with the realisation of the diode system and then some experiments with pumping an Yb-doped fiber using a similar laser.

This master thesis work was carried out at the Royal Institute of Technology (KTH) within the Laser Physics and Quantum Optics research group at the AlbaNova University Center.

Chapter 2

Theory

2. Lasers

Light amplification of stimulated emission of radiation or for short a laser is an electro optical device that creates coherent radiation. It consists of a gain medium inside an optical cavity, the gain medium can be a liquid, a gas, a solid state laser or free electrons. The gain medium is pumped using an electrical current, a flash light or a laser, a light beam with low divergence and with a certain wavelength is created. Depending on the type of gain medium you use you get a certain laser type the different types are gas lasers, solid state lasers or diode lasers and liquid lasers.

In this thesis work, the laser in use is a diode laser, more about this laser type in section 2.2.

2.1.1 The laser diode bar

The laser diode is a laser bar with several adjacent emitters typically 20 where the active layer is a semiconductor with a pn-junction that is activated using a pulsed current. Because of the emitter height of 1×100 microns and the rectangular cross section the output, the radiation of diode laser bars diverges fastly along the x-axis or the fast axis (FA) and slowly along the y-axis or the slow-axis (SA). This is schematically described in figure 2.1.1 and an image in 2.1.2.

The divergens of the fast axis is $2 \cdot 57^\circ$ and the divergens of the slow axis is $2 \cdot 5.7^\circ$ this gives the numerical aperture (NA), of the diode output, as $\sin(\text{F A}) = \sin(57^\circ) = 0.84$.

The specific wavelength of each emitter of the 20 emitters where measured using a spectrometer and a translation stage and the maximum value in each point for all of the 20 emitters are presented in plot 2.1.3.

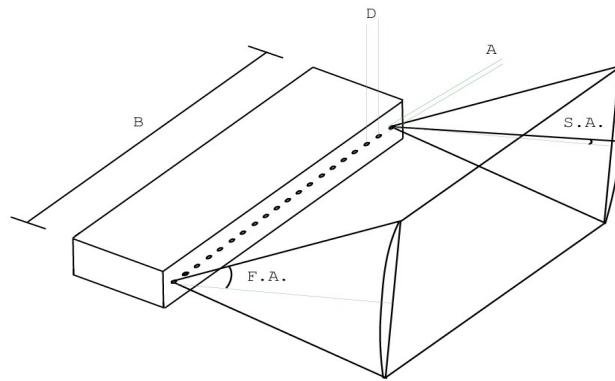

Figure 2.1.1. Schematic of the emitter array.

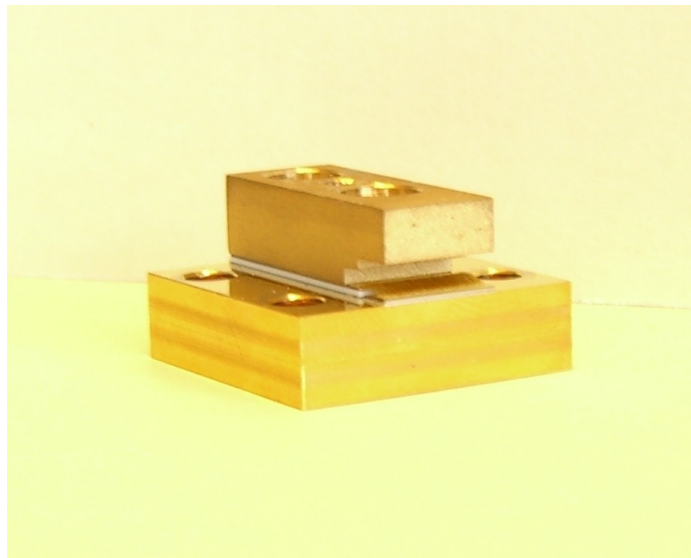

Figure 2.1.2. An image of one of the diode bars used in this thesis work.

2.2 Focusing models

A typical system for focusing the light from a diode laser we created by a fast axis collimation (FAC) lens, a slow axis collimation (SAC) lens and one or more focusing lenses. The FAC lens can be a spherical cylinder micro lens or a gradient index lens and the SAC is a aspherical cylindrical lens that is tilted 90° around the optical axis compared to the FAC lens [9].

The light beam from the diode laser can be described using Gaussian wave theory, and you get the formula for the Gaussian laser field by solving Helmholtz equation, $(\nabla^2 + k^2)A = 0$, in cylindrical coordinates and under

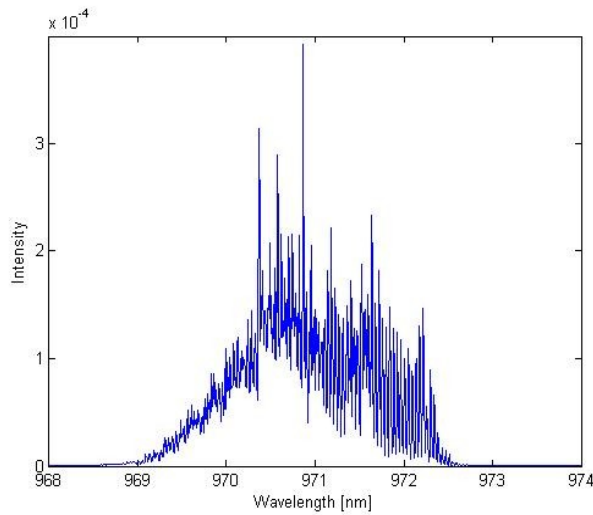

Figure 2.1.3. Wavelength spectra for the diode laser at 1 V and 20° C.

the paraxial approximation you get

$$\psi(r, z') = \sqrt{\frac{2}{\pi}} \frac{1}{w(z')} e^{-\frac{r^2}{w(z')^2}} e^{-ik_0 n_{air} \left(z' + \frac{r^2}{w(z')^2} \right) + i\psi(z')} \quad (2.2.1)$$

k_0 is the wavenumber in free space,

$$w(z') = w_0 \sqrt{1 + \left(\frac{\lambda z'}{\pi w_0^2 n_{air}} \right)^2} \quad (2.2.2)$$

is the local spot size at z , then

$$R(z') = z' + \left(\frac{\pi w_0^2 n_{air}}{\lambda} \right)^2 \frac{1}{z'} \quad (2.2.3)$$

is the phase front radius of curvature,

$$\psi(z') = \tan^{-1} \frac{\lambda z'}{\pi w_0^2 n_{air}} \quad (2.2.4)$$

λ is the wavelength, n_{air} is the refractive index of the medium between the diode and the microlens and w_0 is the spot size of the emitting area of the laser diode. [7, 6]

2.2.1 Micro lenses

Micro lenses, see figure 2.2.4, are manufactured in a number of ways they are moulded, drawn in the same manor as optical fibers or grinded using a ultra precision grinding method witch is the method used for manufacturing

the lens that is used in this thesis work [10].

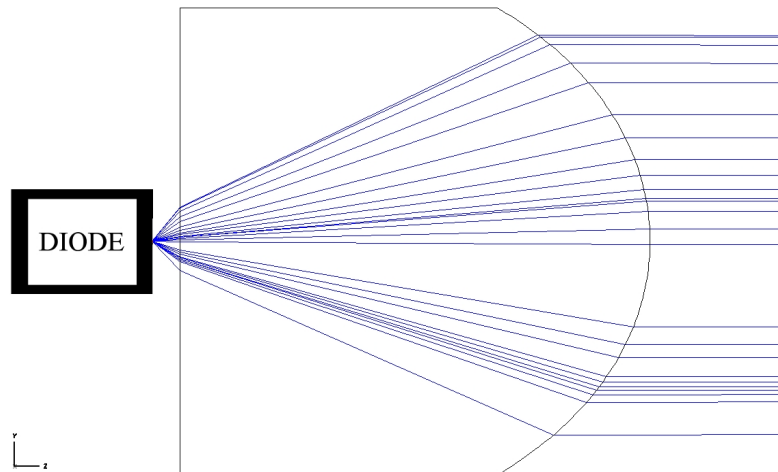

Figure 2.2.4. Picture of a micro lens generated in Zemax

2.2.2 Beam twister

Beam twisters are cylindrical lenses that is twisted 45° around the optical axis and is placed after a micro lens to increase the collimation of the fast axis. The beam twister rotates the ray fan 90° around the optical axis, see figure 2.2.5. This is one way of dealing with the astigmatism that occurs in diode lasers.

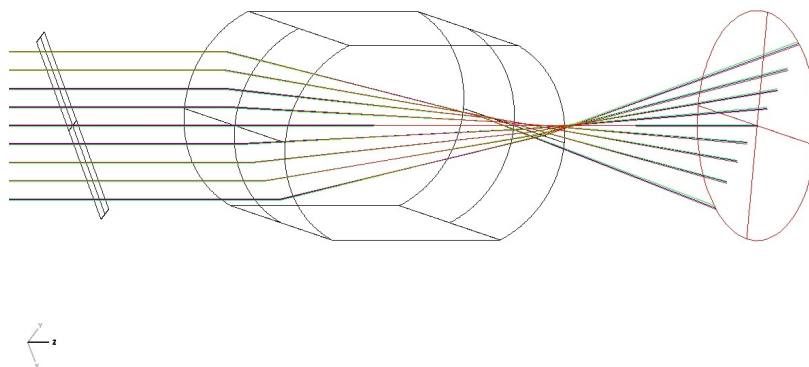

Figure 2.2.5. Picture of a beam twister generated in Zemax

This works because the light from the diode can be described by Hermite-Gaussian equations and the parallel collimated light by Laguerre-Gaussian equations. This means that by tilting the lens 45° you transform the laser beam into beams with a radial symmetrical intensity [3, 4].

2.2.3 Gradient index lenses

Gradient index (GRIN) lenses are made by a gradual variation of the refractive index in the lens [8]. The types of GRIN lens that is suitable for

FAC is either a rod lens with a parabolical refractive index distribution or a cylindrical lens with a radial refractive index distribution, see figure 2.2.6. One of the advantages with a GRIN rod lens compared to a normal lens is that the optical surface of the rod lens is flat and it is therefore easier to adjust in respect to the diode.

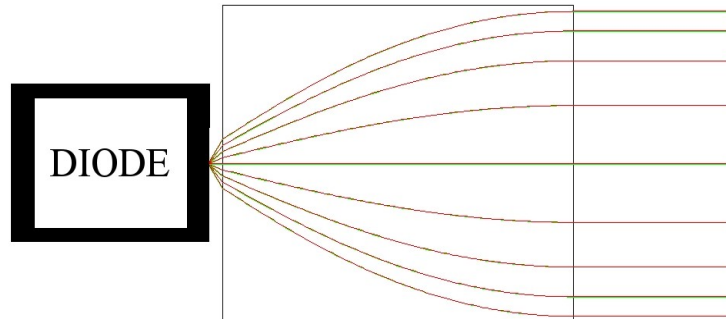

Figure 2.2.6. Picture of gradient index lens generated in Zemax

Reasons why we didn't use a GRIN lens in the final system is that the lens was very hard to simulate correctly in Zemax and one of the GRIN lenses advantages that the distance diode-laser is larger than for a micro lens weren't that great for our diode laser.

2.2.4 Other focusing models

Other options considered is micro step mirrors [11], micrograting-array beam shapers [12], two-mirror beam-shaping [5] and reflective two-wedge-angle prism arrays [13]. There is of course many more focusing models for collimation of a diode laser and there are also combinations of them.

2.3 Fibers

A fiber consists of a core, a cladding and an outer coating as described in 2.3.7, the core is often made of silica and has a higher refractive index n than the cladding. This will cause total internal reflection which will lead to propagation along the optical axis in an multi-mode optical fibre.

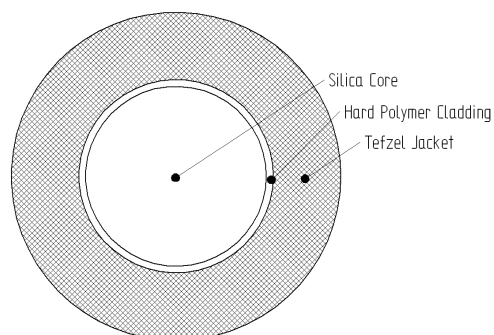

Figure 2.3.7. Schematic picture of a fibre

Chapter 3

Methodology

In this section I will explain how we simulated the different focusing methods in Zemax, and also compare these models and explain why we choose to realize the method that we did.

3.1 Simulations

All the simulations in this thesis work has been preformed in Zemax-EE [2] the lenses are ether simulated, from the built in library in Zemax or lens files directly from the manufacturer. The diode has been simulated using a macro [1] that based on the length and width of the source line and the half angle in the x and y directions gives parameters for a lens system that simulates the diode. The length where obtained by taking measurements on the diode, the half angles by placing a paper on a shield 15 cm from the diode and the width of the diode emitter line where obtained from the diode documentation.

3.1.1 Micro lens system

For fast axis collimation we used a cylindrical micro lens from Ingeneric (FAC-08-900) with an effective focal length of 0.90 mm a size of 1.5 x 1.5 x 13 mm³ and a numerical aperture of 0.8, for the slow axis collimation we use a cylindrical lens from Thorlabs (LJ1125L1-B) with a focal length of 40 mm and finally a cylindrical lens from Thorlabs (LJ1014L1-B) with a focal length of 25.40 mm and a spherical lens from Thorlabs (LA1576-B) with a focal length of 12 mm to focus the beam into the fibre. The total length of the system is 88 mm for a schematic view of the set up see figure 3.1.1. The micro lens were simulated using a Zemax lens file from the lens manufacturer, Ingeneric, and the rest of the lenses were directly generated using the built in lens library in Zemax.

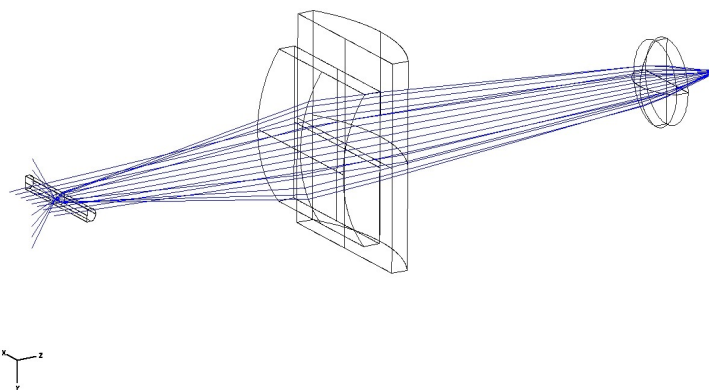

Figure 3.1.1. Picture of micro lens system generated in Zemax

A spot diagram was generated, see figure 3.1.2, the circle in the diagram has a radius of 200 μm which illustrates the edge of a 400 μm fiber.

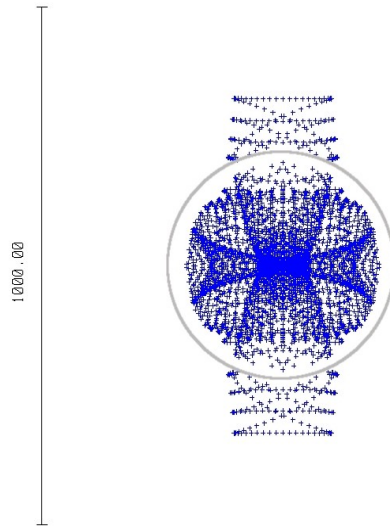

Figure 3.1.2. Spot diagram of final surface in the micro lens system generated in Zemax, the axis on the left is 1000 μm .

To find the right fiber we need the numerical aperture of the theoretical fiber which we can calculate from the maximum angle of the fibre which is

$$\arctan\left(\frac{2880 - 200}{6183}\right) \approx 23^\circ \quad (3.1.1)$$

where 2880 μm is the maximum radius at the last surface, 200 μm is the radius of one of the fibers and 6183 μm is the distance between the last surface and the spot. This gives a numerical aperture of

$$NA = \sin(\arctan(23^\circ)) \approx 0.4 \quad (3.1.2)$$

so a BFL48-400 fiber from Thorlabs with an NA of 0.48, which correspond to an angle of 28° , will work great.

3.1.2 Beam twister

After making several simulations in Zemax we realised that with the microlens from Ingeneric there was no use for a beam twister in the system.

3.1.3 Gradient index

This method has a lot of similarities to the micro lens system the only difference is that you replace the micro lens with a lens that has a gradient index of refraction. The reason that we didn't choose to realise this system is that GRIN lenses are harder to simulate in Zemax than microlenses.

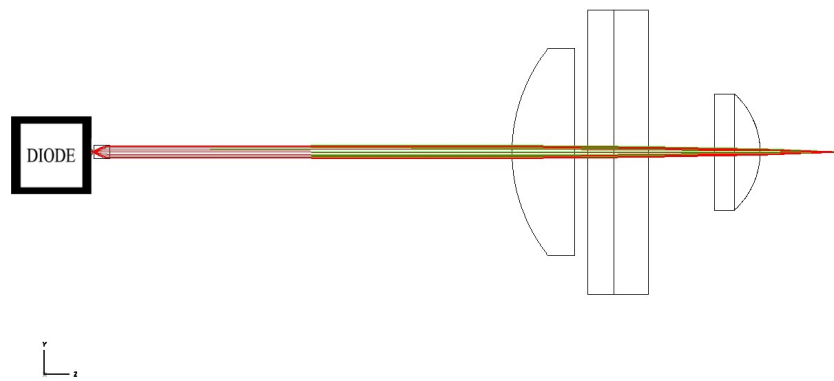

Figure 3.1.3. Picture of the GRIN system generated using Zemax.

Chapter 4

Results

4.1 Set up

The set up consists of a laser diode mounted on a copper cooler that keeps the diode at 16°C , a FAC lens on a holder that is attached to a x,y,z-translation stage, the lenses (A, B and C) in there holders and a fiber holder with multiple v-grooves for different diameters of fiber on a x,y,z-translation stage. An image of the laboratory set up can be viewed in figure 4.1.1.

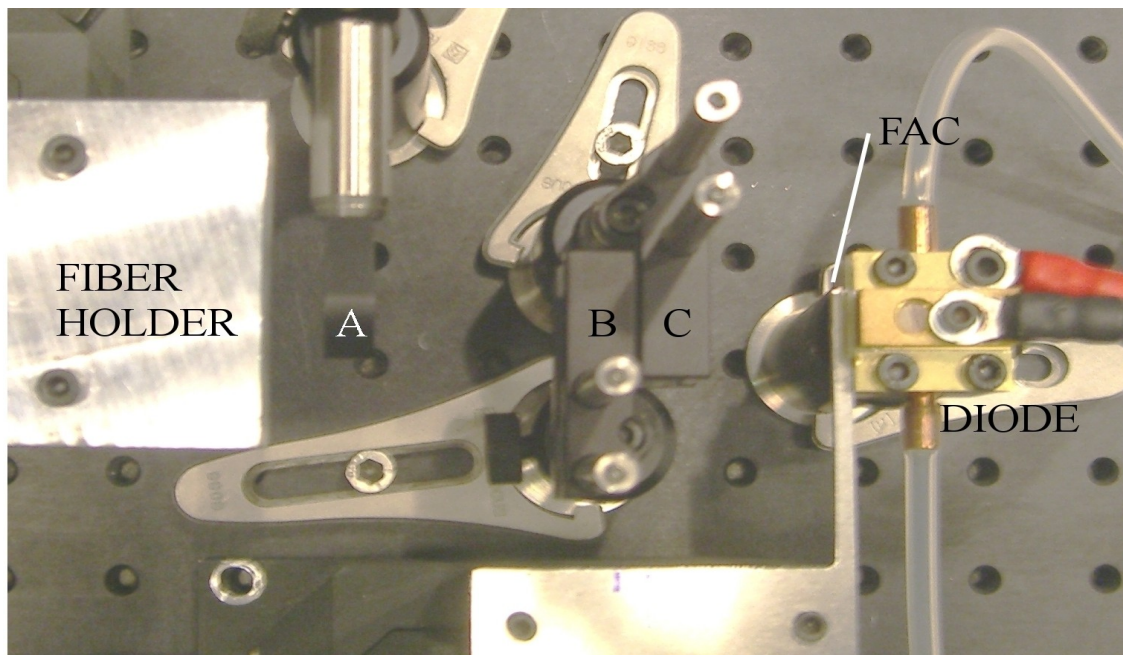

Figure 4.1.1. An image of the set up.

4.2 Diode

The diodes that we used were not so high power as we thought, normal figures for a diode laser is 1 A in give 1 W of power out. As we can see in figure 4.2.2 this wasn't true for our laser. Another problem was that only 10 % of the power made it through the fast axis collimation lens. The result was therefore inadequate to perform the laborations.

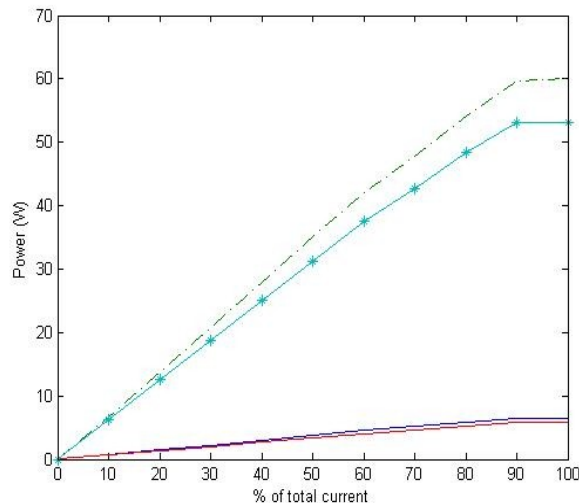

Figure 4.2.2. A plot of Power/Current directly after the diode and after the FAC lens.

4.3 Beam radius

The beam radius was measured by moving a razor blade across the beam axis in x/y-directions and measuring the power after the razor blade using a power meter. This was carried out after every lens to find the right spot for the next lens, the results for the final spot you can see in figure 4.3.3.

If you assume that the beam has a Gaussian distribution of the intensity of the cross-section then the spot size will be the distance in translation between 16% and 84% of the total power. The horizontal lines in the figure are the 16% and 84% lines and the vertical lines are there to ease calculations of the spot size. The final spot size is, as you can see from the figure, 146 μm horizontally and 83.5 μm vertically which is good enough to fit in to the smallest of our fiber that has a diameter of 200 μm .

The measurements were done at two thirds of maximum power and the laser signal were pulsed with a frequency of 100 Hz and a width of 1 ms. This gives a total pulse time of around $100 * 0.001 = 0.10\text{s}$ during one second which correspond to a duty cycle of 10%.

4.4 Results from diode laser focusing

These are some of the reasons for not using the first type of diodes.

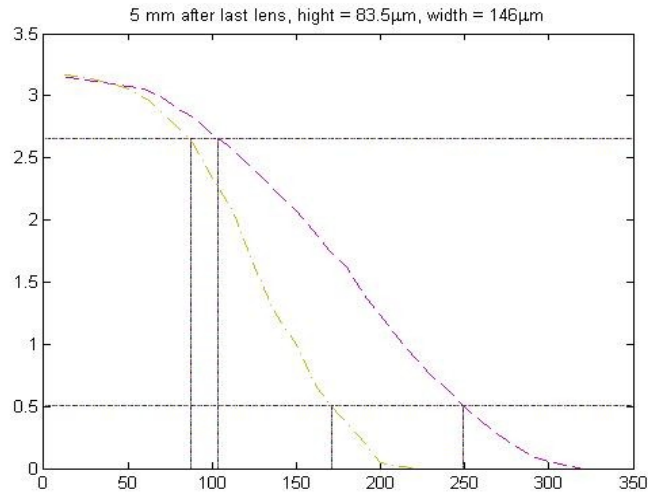

Figure 4.3.3. Plots of power after razorblade.

The m^2 value was greater than expected

greater M^2 than expected, show plots and explain system with FAC lens and $f=50$ mm lens.

The system was designed based on the measurement made on the first lens, the values of the angle of the fast axis and the slow axis of this diode laser differed greatly from the other diodes. This is illustrated in Figure 4.4.4.

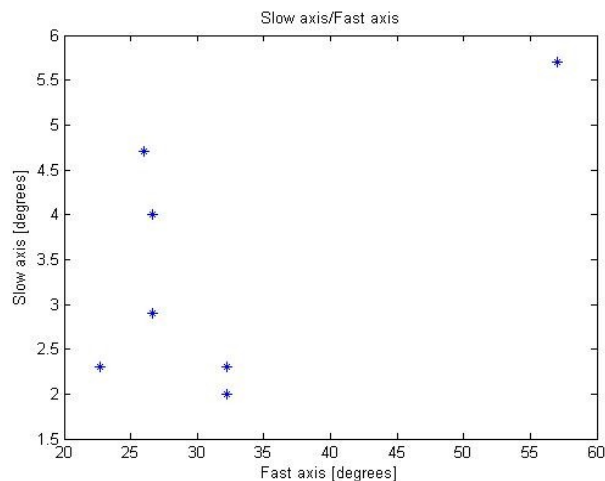

Figure 4.4.4. Plot of the fast- and slow-axis half-angles, the one in the upper right corner was used in the simulations.

One of the hardest part in the calibration of a system like this one is the distance from the diode laser to the first lens, even when mounting the diode on a translation stage we weren't able to get the accuracy that was needed.

The output power of the system, a "good" system has a ratio of on 1 A in equals 1 W out, my system where in the region of 1 A in and 0.4 W out. This would give a maximum output of 40-45 W instead of the expected 100 W.

4.5 Laborations

Instead of using the diode laser set up from the first part we used a diode laser from Limo during the laborations but it is of the same type. The set up for front locking of a fiber laser using a thermocontrolled Bragg grating can be observed in figure 4.5.5.

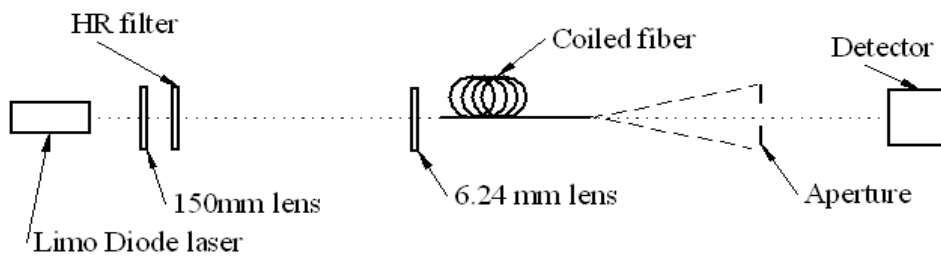

Figure 4.5.5. An schematic image of the set up.

The object of the laborations is to focus the diode laser into a coiled fiber and make the fiber lase. This fiber was doped with ytterbium(Yb^{3+}). Infront of the fiber there is a thermo controlled Bragg grating that enables us to narrow down the wavelength. How a Bragg grating works is illustrated in figure 4.5.6.

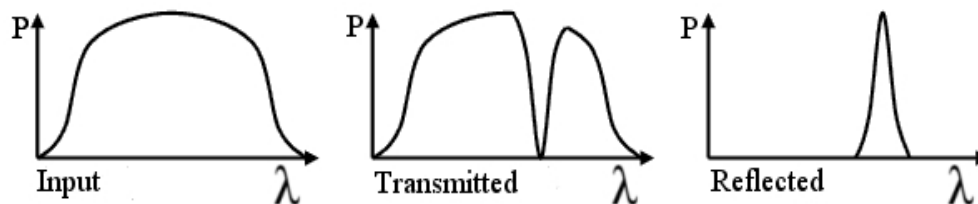

Figure 4.5.6. Plot of the spectral response without Bragg grating, with a uncalibrated Bragg grating and with a good calibrated Bragg grating.

The calibration of the Bragg grating where performed by using a HeNe laser, by calibration here we mean the placement of the crystal in front of the fibre. This was done using a x,y,z- translation stage.

An Ytterbium doped fiber was used because the gain bandwidth is large, they have a simple electronic level structure with only one excited state and the quantum defects are small which allows high power efficiencies and reduces the thermal effects at high powers.

To get an idea of the Limo diode laser the far field spectrum was measured, the results of this measurement can be observed in figure 4.5.7.

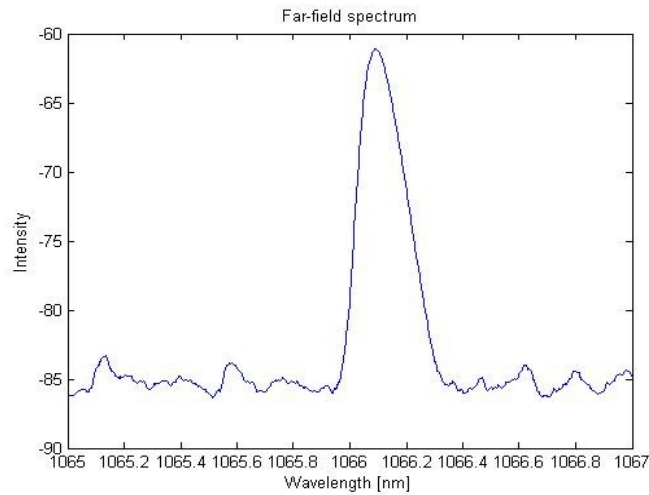

Figure 4.5.7. Far-field spectrum of laser light from lasing fiber.

Then the effect of the diode laser was measured before and after the fiber, in this case we used a short fiber because the object was to measure how much that enters the fiber not how much that is lost in the almost 2 meter long fiber. From these measurements a coupling efficiency of 72% was calculated. The results can be observed in figure 4.5.8.

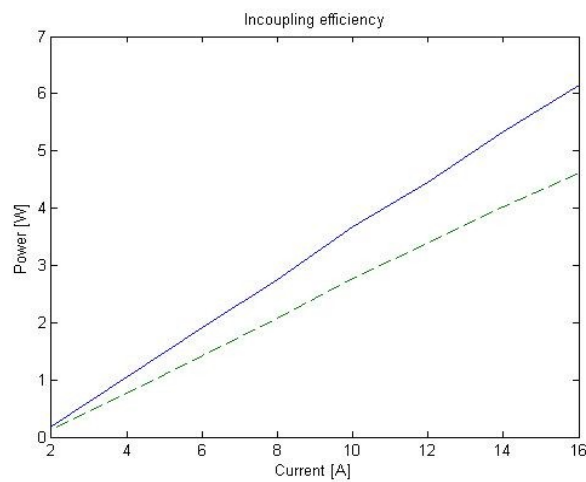

Figure 4.5.8. Coupling efficiency into fiber, 72 %.

The efficiency of the fiber laser was measured, the results can be observed in figure 4.5.9.

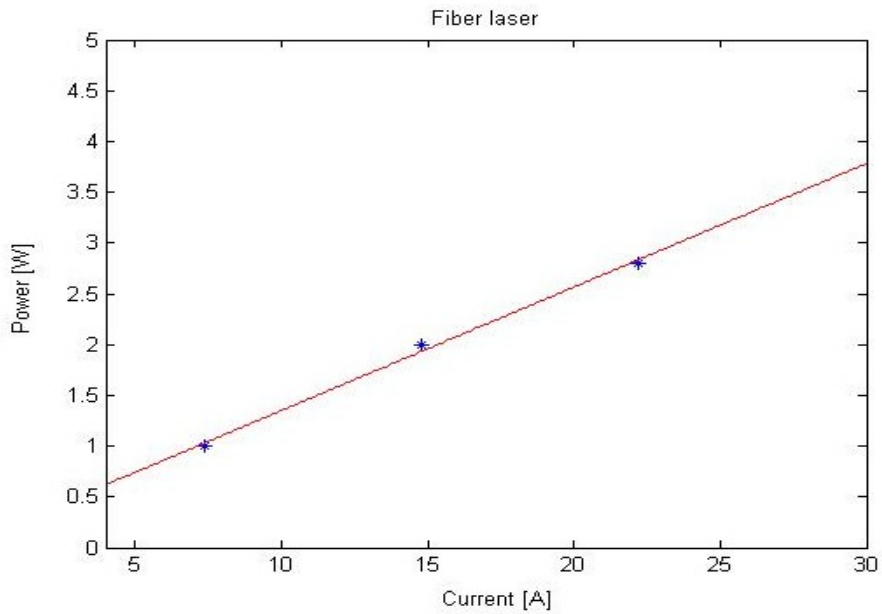

Figure 4.5.9. A plot of the lasing power of the fiber laser.

By mounting the Bragg grating to a heat sink we were able to adjust its temperature, the heat will make the material expand, this expansion will lead to a small change in the transmitted wavelength, this is illustrated in figure 4.5.10. where the temperature is varied between 15°C and 80°C.

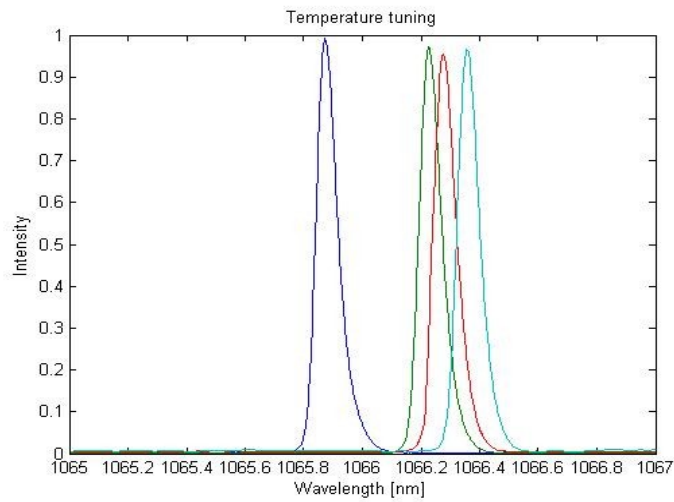

Figure 4.5.10. Temperature tuning of wavelength at 15°C, 40°C, 60°C and 80°C.

M^2 of the final diode pumped Yb-fiber laser was measured, this can be observed in figure 4.5.11.

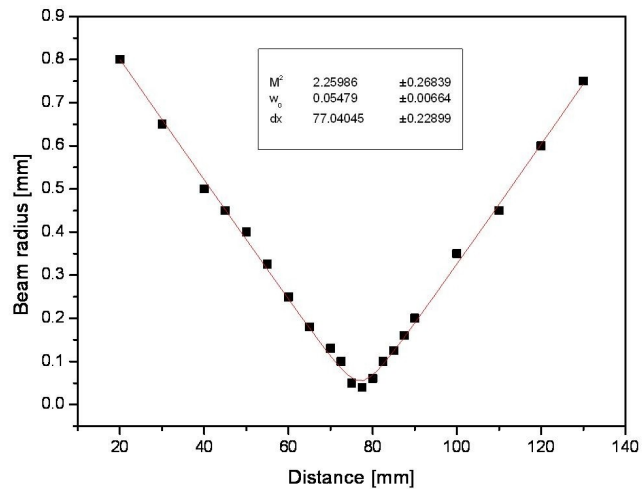

Figure 4.5.11. M^2 measurements on diode pumped Yb-doped-fiber-laser

Chapter 5

Discussion

The main part of this thesis work was spent designing several different set ups in Zemax, in retrospect this might not have been the best. The designs were based on information from the lens manufacturers and measurements done on one of the diode lasers. This meant that when the first diode lost most of its power all the designing where useless and it was impossible to focus a large percentage of the laser light into the fiber. So instead of using the designed set up a diode laser from Limo that already where focused into a fiber and therefore easy to handle. In the laborations the fiber where coiled to minimize the number of modes, and the Bragg grating where tuned all of this where done so the wavelength where so short as possible and the power was maximized. The laborations where a success but it would have been greater if we could have done the same using the first diode lasers. This diode degraded during the measurements which made it impossible to use and this degradation was the main reason for using the pulsed LIMO laser in the final testing.

Bibliography

- [1] Diode macro for zemax-ee.
[http://www.zemax.com/appnotes/modeling a laser diode/index.html](http://www.zemax.com/appnotes/modeling%20a%20laser%20diode/index.html).
- [2] Software package - zemax-ee. <http://www.zemax.com>.
- [3] E. Abramochkin and V. Volostnikov. Beam transformations and non-transformed beams. *Optics Communications*, 83:123–135, 1991.
- [4] L. Allen, M. W. Beijersbergen, R. J. C. Spreeuw, and J. P. Woerdman. Orbital angular momentum of light and the transformation of Laguerre-Gaussian laser modes. *Physical Review A (Atomic, Molecular, and Optical Physics)*, 45:8185–8189, June 1992.
- [5] W A Clarkson and D C Hanna. Two-mirror beam-shaping technique for high power diode bars. *Opt. Lett.*, 21(6):375–7, 1996.
- [6] H.M.; Dragone C. Edwards, C.A.; Presby. Ideal microlenses for laser to fiber coupling. *Lightwave Technology, Journal of*, 11(2):252–257, Feb 1993.
- [7] Frank G. He, Yongzhi; Shi. Ideal microlens design for flattening the equiphase distribution of a gaussian laser beam. *IEEE Photonic Technology Letters*, 16(1):114–116, Jan 2004.
- [8] Roman Ilinsky. Gradient-index meniscus lens free of spherical aberration. *J. Opt. A: Pure Appl. Opt.* 2, pages 449–451, 2000.
- [9] Amir Naqwi and Franz Durst. Focusing of diode laser beams: a simple mathematical model. *Applied Optics*, 29, no. 12, 20 April 1990.
- [10] Volker Sturm, Hans-Georg Treusch, and Peter Loosen. Cylindrical micro lenses for collimating high-power diode bars. *SPIE*, 3097:717–726.
- [11] H-G. Treusch, Keming Du, M. Baumann, V. Sturm, B. Ehlers, and P. Loosen. Fiber-coupling technique for high-power diode laser arrays. *SPIE*, 3267:98–106.
- [12] Guoxing Zheng, Chunlei Du, Chongxi Zhou, and Chunyan Zheng. Micrograting-array beam-shaping technique for asymmetrical laser beams. *Applied Optics*, 44, no. 17, 10 June 2005.
- [13] Guoxing Zheng, Chunlei Du, Chongxi Zhou, and Chunyan Zheng. Laser diode stack beam shaping by reflective two-wedge-angle prism arrays. *Optical Engineering*, 44(4):044203, 2005.